ADVANTEST®
ADVANTEST CORPORATION

R3132 Series
Spectrum Analyzer
Operation Manual

MANUAL NUMBER FOE-8335156H00

Applicable models

R3132
R3132N
R3162
R3172
R3182

product.

- When the product has ventilation outlets, do not stick or drop metal or easily flammable objects into the ventilation outlets.
- When using the product on a cart, fix it with belts to avoid its drop.
- When connecting the product to peripheral equipment, turn the power off.

- **Caution Symbols Used Within this Manual**

Symbols indicating items requiring caution which are used in this manual are shown below together with their meaning.

DANGER: Indicates an item where there is a danger of serious personal injury (death or serious injury).

WARNING: Indicates an item relating to personal safety or health.

CAUTION: Indicates an item relating to possible damage to the product or instrument or relating to a restriction on operation.

- **Safety Marks on the Product**

The following safety marks can be found on Advantest products.

 : ATTENTION - Refer to manual.

 : Protective ground (earth) terminal.

 : DANGER - High voltage.

 : CAUTION - Risk of electric shock.

- **Replacing Parts with Limited Life**

The following parts used in the instrument are main parts with limited life.

Replace the parts listed below before their expected lifespan has expired to maintain the performance and function of the instrument.

Note that the estimated lifespan for the parts listed below may be shortened by factors such as the environment where the instrument is stored or used, and how often the instrument is used.

The parts inside are not user-replaceable. For a part replacement, please contact the Advantest sales office for servicing.

Each product may use parts with limited life.

For more information, refer to the section in this document where the parts with limited life are described.

Safety Summary

To ensure thorough understanding of all functions and to ensure efficient use of this instrument, please read the manual carefully before using. Note that Advantest bears absolutely no responsibility for the result of operations caused due to incorrect or inappropriate use of this instrument.

If the equipment is used in a manner not specified by Advantest, the protection provided by the equipment may be impaired.

- **Warning Labels**

Warning labels are applied to Advantest products in locations where specific dangers exist. Pay careful attention to these labels during handling. Do not remove or tear these labels. If you have any questions regarding warning labels, please ask your nearest Advantest dealer. Our address and phone number are listed at the end of this manual.

Symbols of those warning labels are shown below together with their meaning.

DANGER: Indicates an imminently hazardous situation which will result in death or serious personal injury.

WARNING: Indicates a potentially hazardous situation which will result in death or serious personal injury.

CAUTION: Indicates a potentially hazardous situation which will result in personal injury or a damage to property including the product.

- **Basic Precautions**

Please observe the following precautions to prevent fire, burn, electric shock, and personal injury.

- Use a power cable rated for the voltage in question. Be sure however to use a power cable conforming to safety standards of your nation when using a product overseas.
- When inserting the plug into the electrical outlet, first turn the power switch OFF and then insert the plug as far as it will go.
- When removing the plug from the electrical outlet, first turn the power switch OFF and then pull it out by gripping the plug. Do not pull on the power cable itself. Make sure your hands are dry at this time.
- Before turning on the power, be sure to check that the supply voltage matches the voltage requirements of the instrument.
- Connect the power cable to a power outlet that is connected to a protected ground terminal. Grounding will be defeated if you use an extension cord which does not include a protected ground terminal.
- Be sure to use fuses rated for the voltage in question.
- Do not use this instrument with the case open.
- Do not place anything on the product and do not apply excessive pressure to the product. Also, do not place flower pots or other containers containing liquid such as chemicals near this

Main Parts with Limited Life

Part name	Life
Unit power supply	5 years
Fan motor	5 years
Electrolytic capacitor	5 years
LCD display	6 years
LCD backlight	2.5 years
Floppy disk drive	5 years
Memory backup battery	5 years

- **Hard Disk Mounted Products**

The operational warnings are listed below.

- Do not move, shock and vibrate the product while the power is turned on. Reading or writing data in the hard disk unit is performed with the memory disk turning at a high speed. It is a very delicate process.
- Store and operate the products under the following environmental conditions.
 - An area with no sudden temperature changes.
 - An area away from shock or vibrations.
 - An area free from moisture, dirt, or dust.
 - An area away from magnets or an instrument which generates a magnetic field.
- Make back-ups of important data.
 - The data stored in the disk may become damaged if the product is mishandled. The hard disc has a limited life span which depends on the operational conditions. Note that there is no guarantee for any loss of data.

- **Precautions when Disposing of this Instrument**

When disposing of harmful substances, be sure dispose of them properly with abiding by the state-provided law.

Harmful substances: (1) PCB (polycarbon biphenyl)
 (2) Mercury
 (3) Ni-Cd (nickel cadmium)
 (4) Other

Items possessing cyan, organic phosphorous and hexadic chromium and items which may leak cadmium or arsenic (excluding lead in solder).

Example: fluorescent tubes, batteries

Environmental Conditions

This instrument should be only be used in an area which satisfies the following conditions:

- An area free from corrosive gas
- An area away from direct sunlight
- A dust-free area
- An area free from vibrations
- Altitude of up to 2000 m

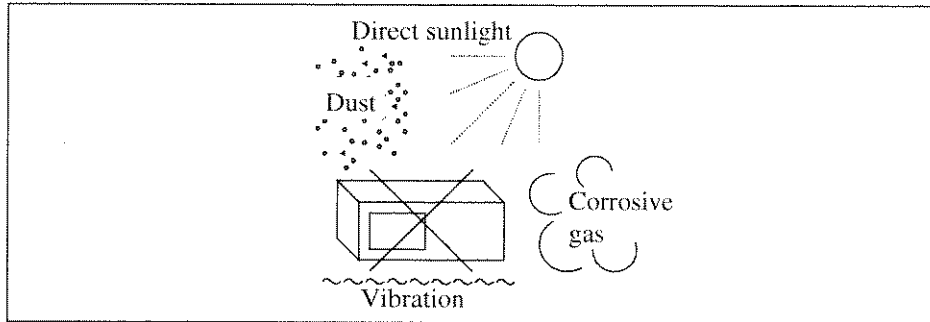

Figure-1 Environmental Conditions

- Operating position

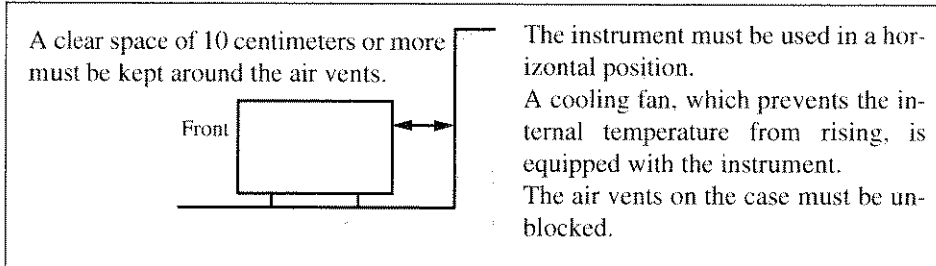

Figure-2 Operating Position

- Storage position

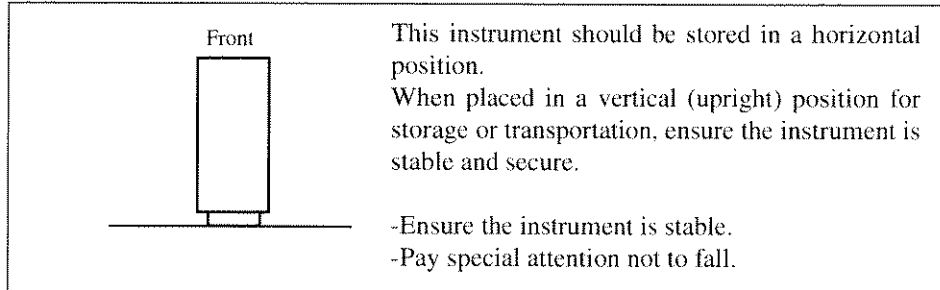

Figure-3 Storage Position



- The classification of the transient over-voltage, which exists typically in the main power supply, and the pollution degree is defined by IEC61010-1 and described below.

Impulse withstand voltage (over-voltage) category II defined by IEC60364-4-443

Pollution Degree 2

Types of Power Cable

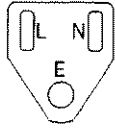
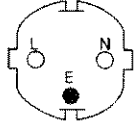
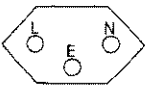
Replace any references to the power cable type, according to the following table, with the appropriate power cable type for your country.

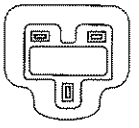
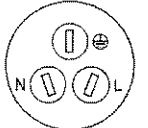
Plug configuration	Standards	Rating, color and length	Model number (Option number)
	PSE: Japan Electrical Appliance and Material Safety Law	125 V at 7 A Black 2 m (6 ft)	Straight: A01402 Angled: A01412
	UL: United States of America CSA: Canada	125 V at 7 A Black 2 m (6 ft)	Straight: A01403 (Option 95) Angled: A01413
	CEE: Europe DEMKO: Denmark NEMKO: Norway VDE: Germany KEMA: The Netherlands CEBEC: Belgium OVE: Austria FIMKO: Finland SEMKO: Sweden	250 V at 6 A Gray 2 m (6 ft)	Straight: A01404 (Option 96) Angled: A01414
	SEV: Switzerland	250 V at 6 A Gray 2 m (6 ft)	Straight: A01405 (Option 97) Angled: A01415
	SAA: Australia, New Zealand	250 V at 6 A Gray 2 m (6 ft)	Straight: A01406 (Option 98) Angled: -----
	BS: United Kingdom	250 V at 6 A Black 2 m (6 ft)	Straight: A01407 (Option 99) Angled: A01417
	CCC: China	250 V at 10 A Black 2 m (6 ft)	Straight: A114009 (Option 94) Angled: A114109

CAUTIONS

The front two feet beneath the front panel have small extensions which can be used to provide a better viewing angle (12-degree tilt).

Note the following when using the extensions:

- Use the analyzer on flat surfaces so that the weight of the analyzer is evenly distributed.
- Do not put any objects on the analyzer.
- Do not lean on the analyzer.
- Do not place anything (hands or other objects) under the analyzer.
- Do not slide the analyzer.
- Do not use excessive force when pressing keys (more than 1 kg).

Make sure the extensions are folded shut when:

- Transporting the analyzer.
- Connecting or disconnecting cables.
- Using the analyzer on a cart.
- The analyzer is not in use.
- The analyzer is in storage.

Do not use the extensible feet if they show signs of excessive wear.

- The extensions may wear out over time. If this occurs, contact ADVANTEST or our service agency for information on how to replace them.

Certificate of Conformity



This is to certify, that

Spectrum Analyzer

R3132 Series

instrument, type, designation

complies with the provisions of the EMC Directive 89/336/EEC in accordance with EN61326 and Low Voltage Directive 73/23/EEC in accordance with EN61010.

ADVANTEST Corp.

Tokyo, Japan

ROHDE&SCHWARZ

Engineering and Sales GmbH
Munich, Germany

PREFACE

This manual provides the information necessary to check functionality, operate and program the R3132 Series Spectrum Analyzer. Be sure to read this manual carefully in order to use the spectrum analyzer safely.

- Organization of this manual
This manual consists of the following chapters:

<p>1. INTRODUCTION</p> <ul style="list-style-type: none"> • Product Description • Accessories • Options • Operating Environment • System Checkout • Cleaning, Storing and Transporting the R3132 Series Spectrum Analyzer • Calibration • Replacing Parts with Limited Life 	<p>Includes a description of the spectrum analyzer and its' parts along with information on its' operating environment and how to perform a system checkout.</p>
<p>2. OPERATION</p> <ul style="list-style-type: none"> • Panel Description • Basic Operation • Measurement Examples • Other Functions 	<p>Describes the names and the functions of each part on the panels. You can learn the basic operation of the spectrum analyzer through the examples shown in this chapter.</p>
<p>3. REFERENCE</p> <ul style="list-style-type: none"> • Menu Index • Menu Map • Menu Function Descriptions • List of Settings 	<p>Shows a list of operation keys, and describes the function of each key.</p>
<p>4. REMOTE PROGRAMMING</p> <ul style="list-style-type: none"> • GPIB Command Index • GPIB Remote Programming • RS-232 Remote Control Function 	<p>Gives an outline of the GPIB and RS-232 interfaces, and how to connect and set them up. Also included are a list of commands necessary for programming and using the program examples.</p>
<p>5. PERFORMANCE VERIFICATION</p> <ul style="list-style-type: none"> • General • Procedures of Performance Verification • Tracking Generator Performance Verification Procedure • Performance Verification for OPT73 (FM Demodulation) • Performance Verification Record Sheet 	<p>Describes the performance verification.</p>
<p>6. PERFORMANCE VERIFICATION (External Mixer)</p> <ul style="list-style-type: none"> • External Mixer OPT16 • External Mixer OPT17 • External Mixer OPT18 • External Mixer OPT19 	<p>Describes the performance verification(External Mixer).</p>

Preface

7. SPECIFICATIONS <ul style="list-style-type: none">• R3132 Specifications• R3132N Specifications• R3162 Specifications• R3172 Specifications• R3182 Specifications• Options	Shows the specifications of the spectrum analyzer.
---	--

- Key notations in this manual
Typeface conventions used in this manual.

Panel keys: In bold type

Example: **MKR, MEAS**

Soft keys: In bold and italic type

Example: ***Normal, Noise/Hz***

The ***1/2, more*** and ***2/2, more*** soft keys are designated by ***1/2_more*** and ***2/2_more*** in this manual.

1 INTRODUCTION

This chapter provides the following information:

- Product description
- A list of standard accessories and power cable options
- Options
- Operating environment
- How to verify that the spectrum analyzer is functioning properly
- How to clean, store, and transport the spectrum analyzer
- Calibration
- Replacing Parts with Limited Life

1.1 Product Description

The R3132 Series spectrum analyzer uses the synthesized local method and allow the user highly stable and highly precise spectrum analysis.

The key features of the R3132 Series spectrum analyzer are listed below.

- (1) Frequency Range: 9 kHz to 3 GHz (R3132/N)
9 kHz to 8 GHz (R3162)
9 kHz to 26.5 GHz (R3172)
9 kHz to 40 GHz (R3182)
Frequency span: Zero, 1 kHz to 3 GHz (R3132/N)
Zero, 1 kHz to 8 GHz (R3162)
Zero, 1 kHz to 26.5 GHz (R3172)
Zero, 1 kHz to 40 GHz (R3182)
- (2) High-speed and high-precision sweep
Frequency span accuracy: 1% or less
Sweep time: 20 ms
- (3) Wide dynamic range
Maximum input level: +30 dBm
Built-in pre-amplifier: -132 dBm noise level
- (4) Frequency counter function with a resolution of 1Hz.
- (5) A power measurement function useful for evaluating radio instruments using measurements such as occupied bandwidth (OBW), adjacent channel power (ACP), channel power, etc.
- (6) An auto tuning function that searches for a signal with the maximum input level.
- (7) Save and recall functions which you can use to store measurement conditions and data in TEXT format.
- (8) A 3.5-inch floppy disk drive which you can use to save screen images in BMP format.
- (9) Support for ESC/P, ESC/P-R and PCL compatible printers.

1.1 Product Description

- (10) Remote control capabilities which allow you to setup an automatic measurement system. This remote control function complies with GPIB and RS-232 specifications.
- (11) High-precision color LCD

1.2 Accessories

Table 1-1 lists the standard accessories shipped with the spectrum analyzer. If any of the accessories are damaged or missing or, to order additional accessories, contact the nearest ADVANTEST Field Office or representative.

Table 1-1 Standard Accessories List

Name of accessory	Type name	Quantity			Remarks
		R3132/ 62/72	R3182	R3132N	
Power cable	A01402	1	1	1	*1
Input cable (50 Ω)	A01261-30	1	1	—	
Input cable (75 Ω)	A01045	—	—	1	
N to BNC adapter	JUG-201A/U	1	—	—	*2
C15 Type adapter	NCP-NFJ	—	—	1	*2
NC to BNC adapter	BA-A165	—	—	1	*2
K to K adapter	5A-SFF40(A)	—	1	—	
SMA to SMA adapter	HRM-501	—	1	—	
SMA to BNC adapter	HRM-517(09)	—	1	—	
Operation manual (This manual)	ER3132/62	1	1	1	

* 1: The cable supplied with the spectrum analyzer depends on what type (specified by model number above) was ordered when the spectrum analyzer was purchased.

There are 11 types of power cable available (see Table 1-2).

To order another power cable, contact an ADVANTEST Field Office or representative. When ordering, refer to power cables by their option number or model number.

* 2: Quantity is 2 when the instrument is equipped with TG option (OPT74).

1.2 Accessories

Table 1-2 Power Cable Options

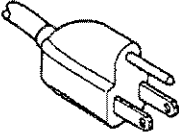
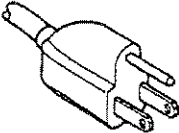
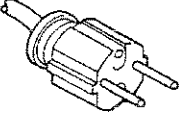
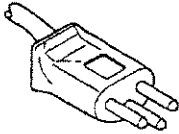
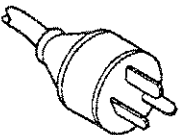
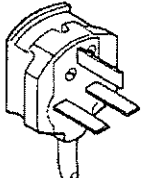
Plug configuration	Standards	Rating, color and length	Model number (Option number)
	JIS: Japan Law on Electrical Appliances	125 V at 7 A Black 2 m (6 ft)	Straight:A01402 Angled:A01412
	UL: United States of America CSA: Canada	125 V at 7 A Black 2 m (6 ft)	Straight:A01403 (OPT95) Angled:A01413
	CEE:Europe DEMKO:Denmark NEMKO:Norway VDE:Germany KEMA:The Netherlands CEBEC:Belgium OVE:Austria FIMKO:Finland SEMKO:Sweden	250 V at 6 A Gray 2 m (6 ft)	Straight:A01404 (OPT96) Angled:A01414
	SEV: Switzerland	250 V at 6 A Gray 2 m (6 ft)	Straight:A01405 (OPT97) Angled:A01415
	SAA: Australia, New Zealand	250 V at 6 A Gray 2 m (6 ft)	Straight:A01406 (OPT98) Angled:-----
	BS: United Kingdom	250 V at 6 A Black 2 m (6 ft)	Straight:A01407 (OPT99) Angled:A01417

1.3 Options

The following options are available for this spectrum analyzer.

- (1) OPT20 Highly Stable Reference Frequency Crystal Oscillator
- (2) OPT27 Narrow-band Resolution Bandwidth
- (3) OPT29 High-Speed Time-Domain Sweep
- (4) OPT73 FM Demodulation
- (5) OPT74 Tracking Generator
(This option can be installed on the R3132, R3132N, R3162 and R3172.)

1.4 Operating Environment

1.4 Operating Environment

This section describes the environmental conditions and power requirements necessary to use the spectrum analyzer.

1.4.1 Environmental Conditions

The R3132 Series should be only be used in an area which satisfies the following conditions:

- Ambient temperature: 0 °C to +50 °C (operating temperature)
- Relative humidity: 85% or less (without condensation)
- An area free from corrosive gas
- An area away from direct sunlight
- A dust-free area
- An area free from vibrations
- A low noise area

Although the R3132 Series has been designed to withstand a certain amount of noise riding on the AC power line, it should be used in an area of low noise. Use a noise cut filter when ambient noise is unavoidable.

- An area allowing unobstructed air flow

The R3132 Series has an exhaust cooling fan on the rear panel and an exhaust vent on the bottom side toward the front. Never block these areas as the resulting internal temperature rise will affect measurement accuracy.

- Avoid operation in the following areas.
- Use a noise cut filter when there is a large amount of noise riding on the power line.

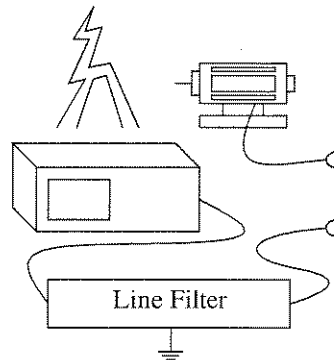
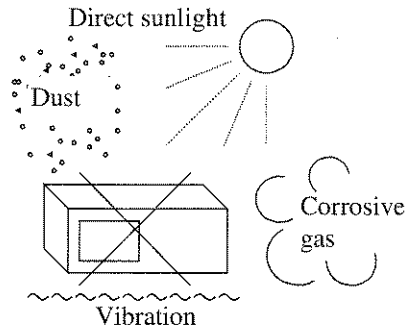

- Keep the rear panel 10cm away from the wall

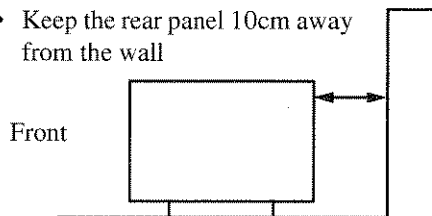

Figure 1-1 Operating Environment

The R3132 Series can be used safely under the following conditions:

- Altitude: 2000 m maximum above the sea level
- Installation category II
- Pollution degree 2

1.4.2 Power Requirements

The power supply specifications of the spectrum analyzer are listed in Table 1-3.

Table 1-3 Power Supply Specifications

	100 VAC Operation	200 VAC Operation
Input voltage range	90 V - 132 V	198 V - 250 V
Frequency range	48 Hz - 66 Hz	
Power consumption	200 VA or below	

CAUTION *To prevent damage, operate the spectrum analyzer within the specified input voltage and frequency ranges.*

During operation, the power supply automatically switches between input voltage levels of 100 VAC and 200 VAC. Be sure, however, to use a power cable that matches the input voltage and meets the related standard (see Table 1-2).

1.4.3 Power Fuse

CAUTION:

1. *When a fuse blows, there may be some problem with the analyzer so contact a qualified ADVANTEST service representative before replacing the fuse.*
 2. *To prevent fires, use the same rating and same model of a fuse.*
-

The power fuse is placed in the fuse holder which is mounted on the rear panel. A spare fuse is located in the fuse holder.

To check or replace the power fuse, use the following procedure:

1. Press the **POWER** switch to the OFF position.
2. Disconnect the power cable from the AC power supply.
3. Remove the fuse holder on the rear panel.
4. Check (and replace if necessary) the power fuse and put it back in the fuse holder.

1.4.3 Power Fuse

Pull out the fuse holder using a slotted head screwdriver.

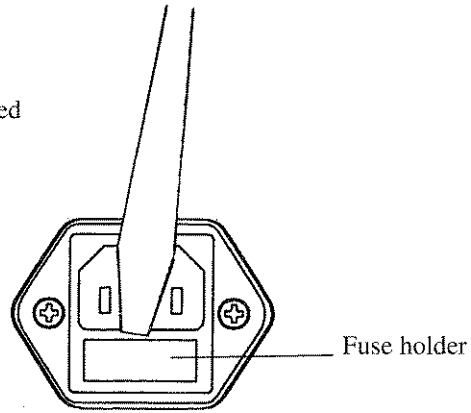

Check (and replace if necessary) the power fuse and put it back into the fuse holder.

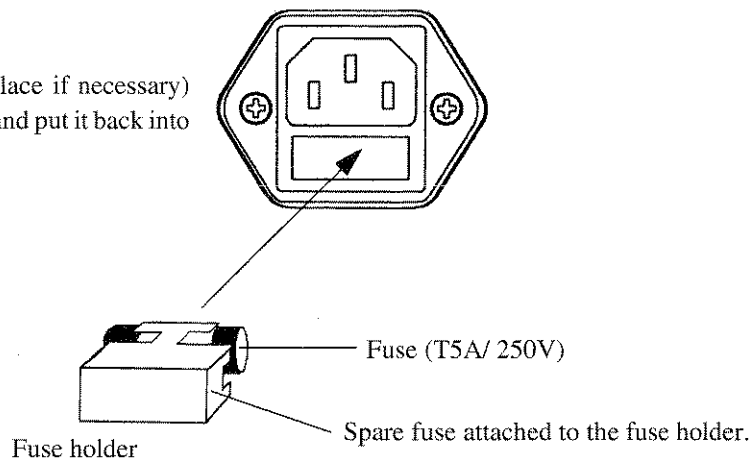

Figure 1-2 Replacing the Power Fuse

1.4.4 Power Cable

A detachable power cable with a three-contact plug is included with the spectrum analyzer. The protective earth ground contact on the plug connects (through the power cable) to the accessible metal parts of the instrument. For protection against electrical shock, insert the plug into a power-source outlet that has a properly grounded, protective-ground contact.

The manufacturer ships a power cable, as ordered, with the spectrum analyzer. A list of other available power cables is shown in Table 1-2. Contact your ADVANTEST representative or the local ADVANTEST Field Office for information on how to order these.

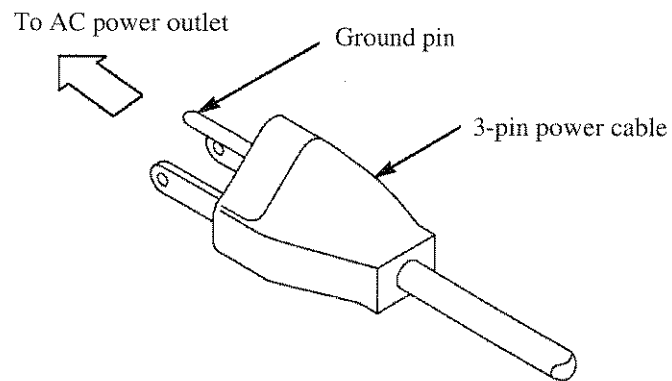

Figure 1-3 Power Cable

1.5 System Checkout

This section describes the Self Test which must be performed when operating the spectrum analyzer for the first time. Follow the procedure below:

CAUTION: Wait at least 30 minutes after turning on the power before using to ensure accurate measurements.

1. Make sure that the **POWER** switch on the front panel is in the OFF position.
2. Connect the power cable provided to the AC power supply connector on the rear panel.

CAUTION: To prevent damage, operate the spectrum analyzer within specified input voltage and frequency ranges.

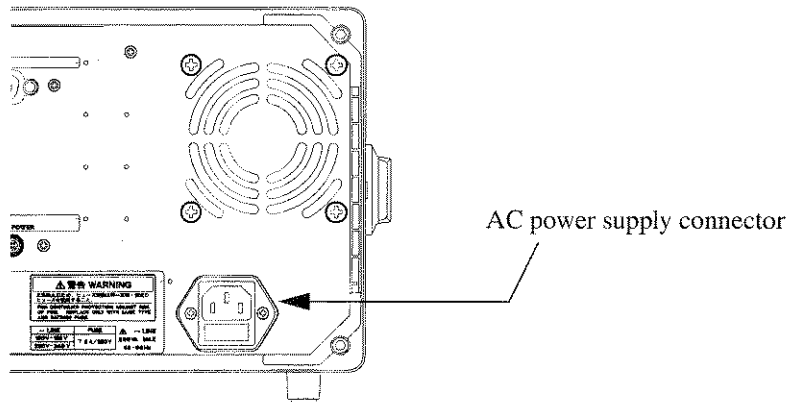

Figure 1-4 Connecting the Power Supply Cable

3. Connect the power cable to the outlet.
4. Press the **POWER** switch to the ON position.
The spectrum analyzer performs the Initial test for approximately three seconds, then displays the startup screen as shown in Figure 1-5.

CAUTION: There is a possibility that the screen display is different from the one shown in Figure 1-5, depending on previously saved conditions.

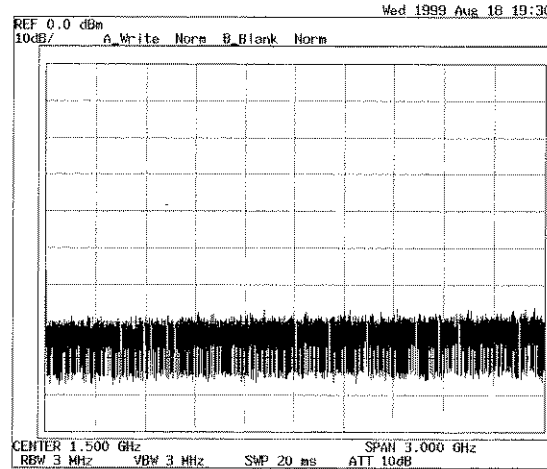

Figure 1-5 Screen Display after Self Tests have Completed

CAUTION: Allow 30 minutes for the R3132 Series to warm up before proceeding the next step.

5. Press **SHIFT**.
The **SHIFT** lamp lights.
6. Press **CONFIG(PRESET)**.
The factory defaults are reset.
The startup screen is displayed as shown in Figure 1-5.
7. Press **SHIFT** and **0**.
The Self Test menu is displayed.

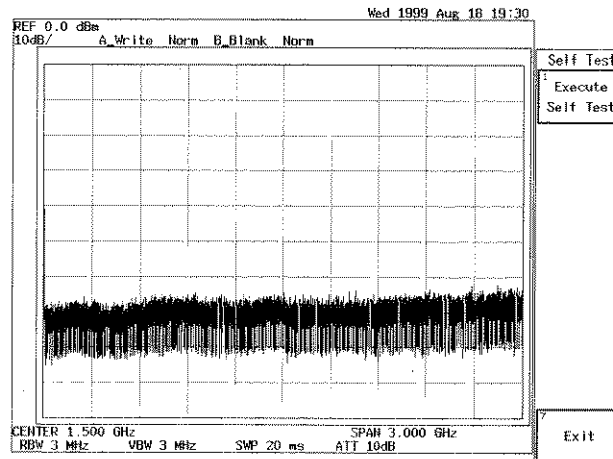

Figure 1-6 Self Test Screen

1.5 System Checkout

NOTE: Pressing *SHIFT* and *0* turns the Self Test mode on. In this mode, only the *SHIFT*, *PRESET* and *COPY* keys, and the currently displayed soft menu can be used. All other panel keys are disabled.

8. Press *Execute Self Test*.

The five test items are executed in order and then the test results are displayed as shown below.

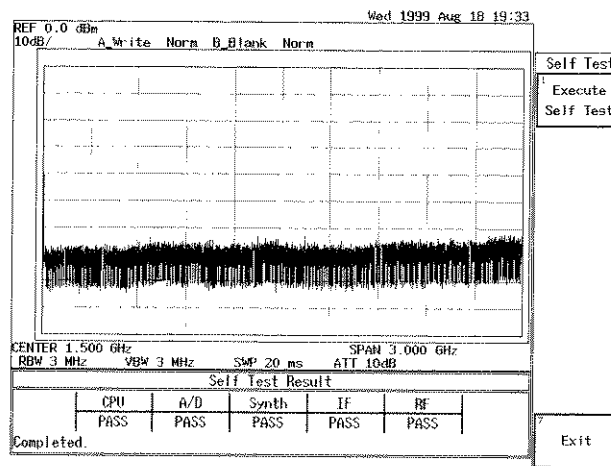

Figure 1-7 Screen Shown after Executing Self Test

CAUTION: If the Self Test detects any errors, do not attempt to use the spectrum analyzer any further. Contact an ADVANTEST service representative as soon as possible.

9. Press *Exit*.
This exits the Self Test mode.

This completes the system checkout.

1.6 Cleaning, Storing and Transporting the R3132 Series Spectrum Analyzer

1.6.1 Cleaning

Remove dust from the outside of the spectrum analyzer by wiping or brushing the surface with a soft cloth or small brush. Use a brush to remove dust from around the panel keys. Hardened dirt can be removed by using a cloth which has been dampened in water containing a mild detergent.

CAUTION:

1. Do not allow water to get inside the spectrum analyzer.
 2. Do not use organic cleaning solvents, such as benzene, toluene, xylene, acetone or similar compounds, since these solvents may damage the plastic parts.
 3. Do not use abrasive cleaners.
-

- Cleaning the Display Filter

Normally cleaning the display filter from the front should be sufficient. However, if necessary, the filter itself can be detached from the spectrum analyzer by removing the two screws on the front. Clean the backside of the filter with a soft cloth.

CAUTION: Do not touch the LCD display with your finger when the filter has been removed.

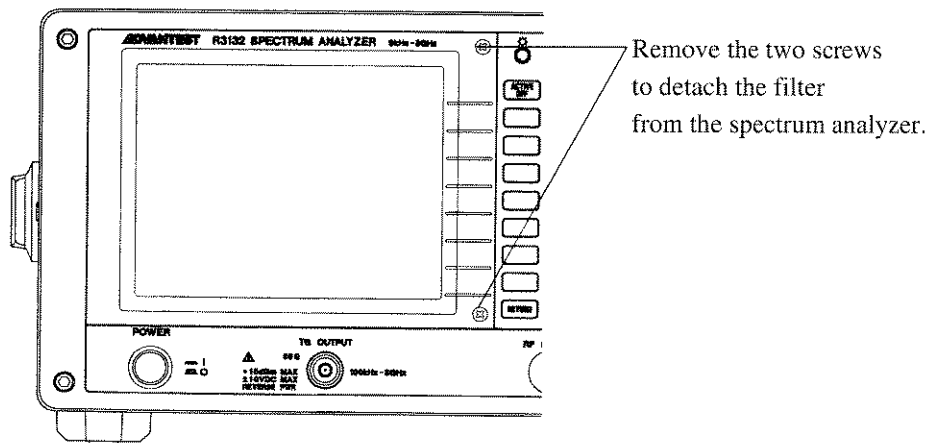

Figure 1-8 Removing the Display Filter

1.6.2 Storing

1.6.2 Storing

Store the spectrum analyzer in an area which has a temperature from -20°C to $+60^{\circ}\text{C}$. If you plan to store the spectrum analyzer for a long period (more than 90 days), put the spectrum analyzer in a vapor-barrier bag with a drying agent and store the spectrum analyzer in a dust-free location out of direct sunlight.

1.6.3 Transporting

When you ship the spectrum analyzer, use the original container and packing material. If the original packaging is not available, pack the spectrum analyzer using the following guidelines:

- To allow for cushioning, use a corrugated cardboard container with inner dimensions that are at least 15 centimeters more than those of the spectrum analyzer.
- Surround the spectrum analyzer with plastic sheeting to protect the finish.
- Cushion the spectrum analyzer on all sides with packing material or plastic foam.
- Seal the container with shipping tape or a heavy-duty, industrial stapler.

If you are shipping the spectrum analyzer to a service center for service or repair, attach a tag to the spectrum analyzer that shows the following information:

- Owner and address
- Name of a contact person at your location
- Serial number of the spectrum analyzer (located on the rear panel)
- Description of the service requested

1.7 Calibration

The R3132 Series requires yearly calibration. Calibration work should be performed at an ADVANTEST CORPORATION site. Please contact ADVANTEST CORPORATION concerning the calibration.

1.8 Replacing Parts with Limited Life

The R3132 Series uses the following parts with limited life that are not listed in Safety Summary.

Replace the parts listed below after their expected lifespan has expired.

Part name	Life
Input attenuator	R3132/32N/62: 2 million cycles
	R3172/82: 2.5 million cycles
Rotary encoder	100,000 cycle

2 OPERATION

This chapter describes the following:

- Front and rear panel controls and connectors
- Screen annotation
- Basic operation
- Measurement examples
- Expanded functions

2.1 Panel Description

2.1.1 Front Panel

This section contains detailed views of the front panel and explanations for the panel keys or connectors shown in those views. Figure 2-1 shows the front panel location of the nine detail views.

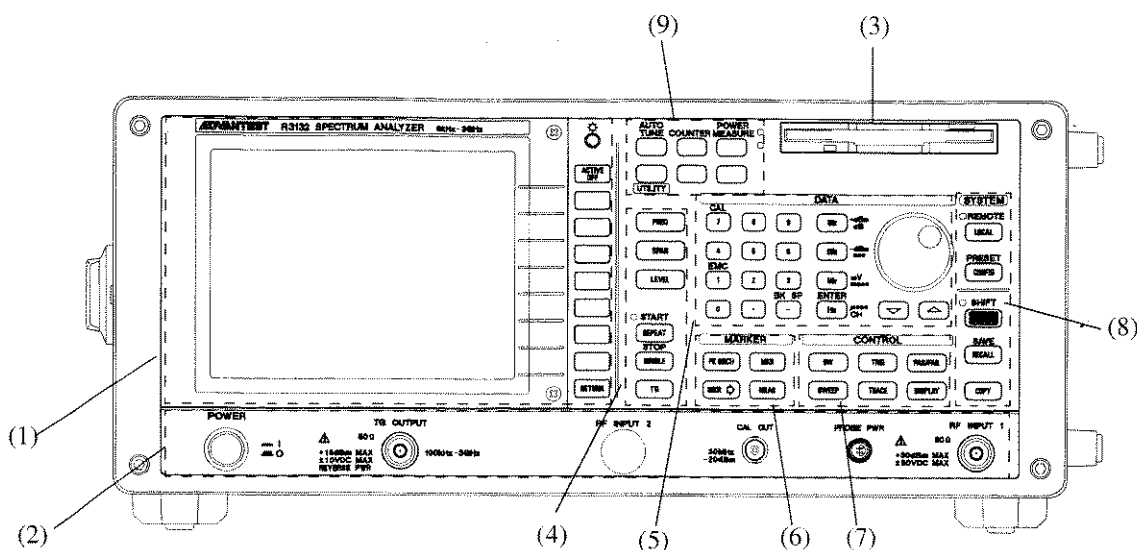

Figure 2-1 Front Panel (R3132/32N/62)

2.1.1 Front Panel

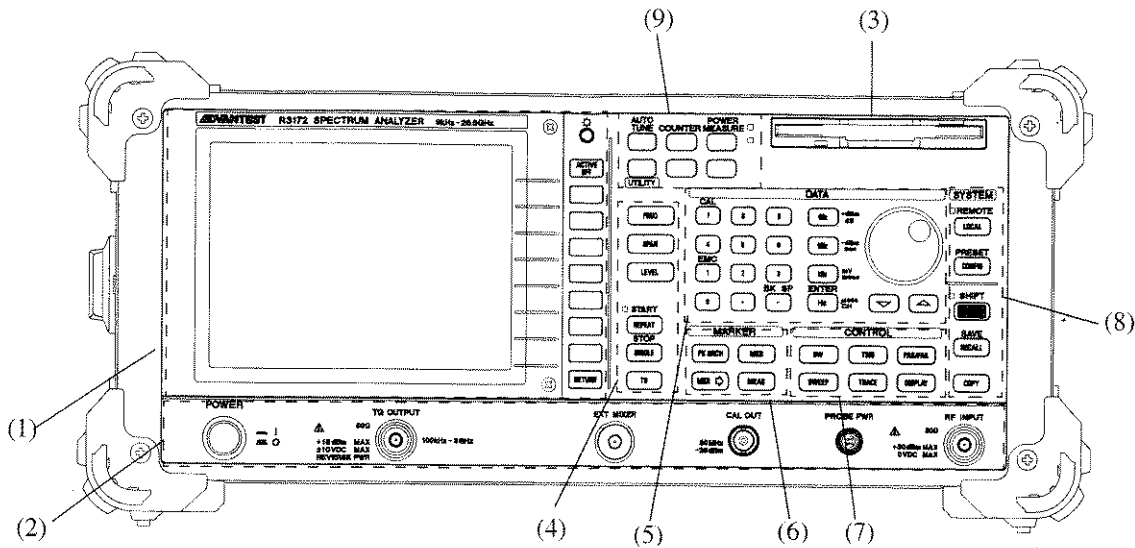

Figure 2-2 Front Panel (R3172)

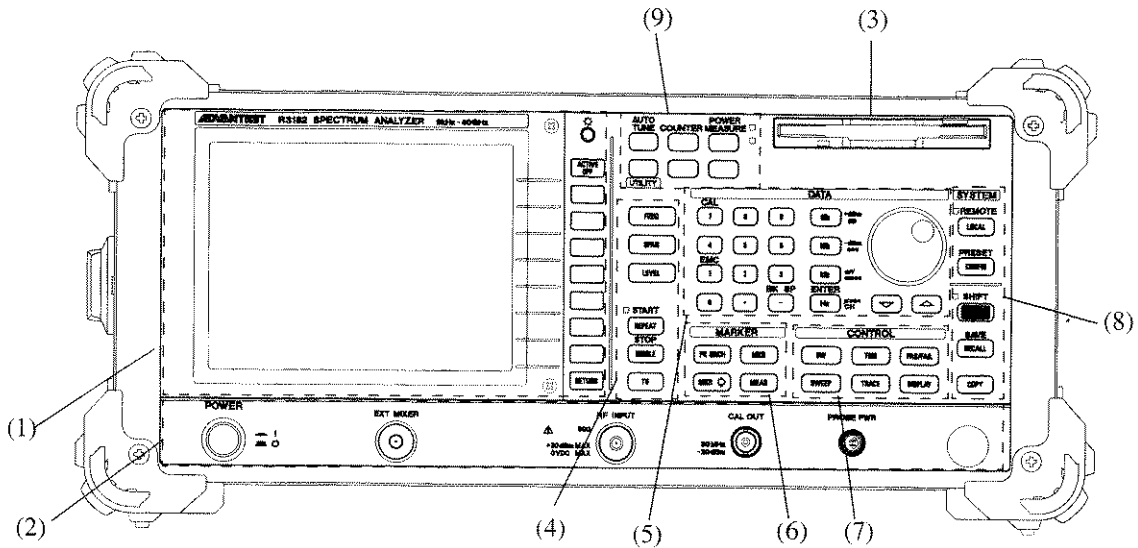
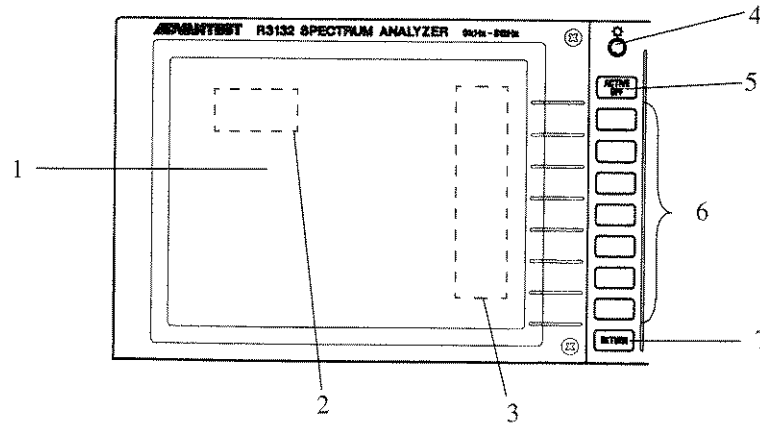

Figure 2-3 Front Panel (R3182)

(I) Display Section



	Control	Description
1	Liquid crystal display (LCD)	Displays trace and measured data
2	Active area	Displays input data and measurement data
3	Soft-menu display	Displays the function of each soft key (up to 7 at one time)
4	Intensity	Adjusts the brightness of the display back light.
5	ACTIVE OFF key	Turns off the active area removing any displayed information
6	Soft keys	Seven keys corresponding to the soft-menu display on the left; pressing a soft key selects the corresponding menu item
7	RETURN key	Used to return the screen display to the previous level of the hierarchical soft-menu structure

2.1.1 Front Panel

(2) Power Switch/Connector Section

- R3132/32N/62

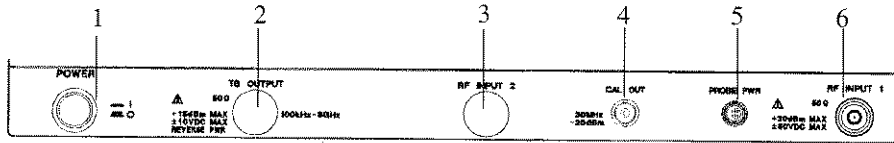

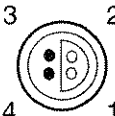
Control		Description
1	POWER switch	Turns the power on or off
2	TG OUTPUT connector	(Option) TG output connector Frequency range is 100 kHz to 3 GHz
3	RF INPUT 2 connector	(Unused)
4	CAL OUT connector	Calibration signal output connector 30 MHz, -20 dBm
5	PROBE PWR connector	Power output for the accessory. The maximum current is 100 mA <div style="display: flex; align-items: center; justify-content: center;"> <div style="text-align: center; margin-right: 10px;"> <p>3 2</p>  <p>4 1</p> </div> <div style="margin-left: 10px;"> <p>1: NC 2: GND 3: -12V 4: +12V</p> </div> </div>
6	RF INPUT 1 connector	Inputs the signal to be measured.

- R3172

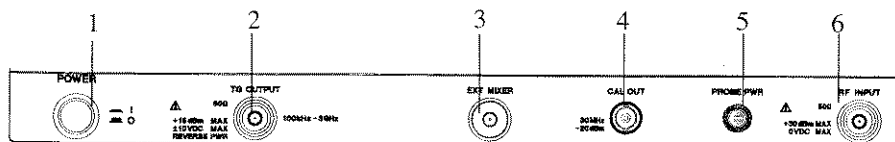

Control		Description
1	POWER switch	Turns the power on or off
2	TG OUTPUT connector	(Option) TG output connector Frequency range is 100 kHz to 3 GHz
3	EXT MIXER connector	(Option) Connects an external mixer to increase the measurement frequency range.
4	CAL OUT connector	Calibration signal output connector 30 MHz, -20 dBm
5	PROBE PWR connector	Power output for the accessory. The maximum current is 100 mA <div style="display: flex; align-items: center; justify-content: center;">  <div style="margin-left: 20px;"> <p>1: NC 2: GND 3: -12V 4: +12V</p> </div> </div>
6	RF INPUT connector	Inputs the signal to be measured.

2.1.1 Front Panel

- R3182

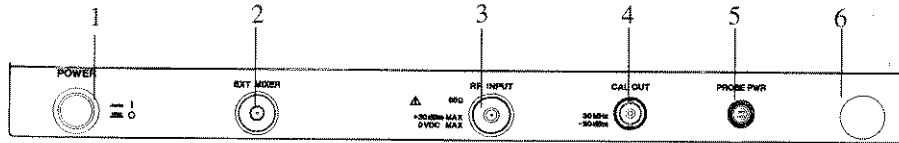

Control	Description
1 POWER switch	Turns the power on or off
2 EXT MIXER connector	Connects an external mixer to increase the measurement frequency range.
3 RF INPUT connector	Inputs the measurement signal.
4 CAL OUT connector	Calibration signal output connector 30 MHz, -20 dBm
5 PROBE PWR connector	Power output for the accessory. The maximum current is 100 mA <div style="display: flex; align-items: center; justify-content: center;">  <div style="margin-left: 20px;"> <p>1: NC 2: GND 3: -12V 4: +12V</p> </div> </div>
6	(Unused)

(3) Floppy Disk Drive Section

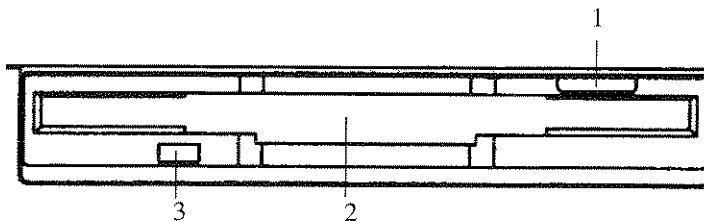

Control	Description
1 Eject button	Used to eject floppy disks from the drive
2 Floppy disk drive door	Insert floppy disks here
3 Access lamp	Turns on when the floppy disk in the drive is being accessed

(4) MEASUREMENT Section

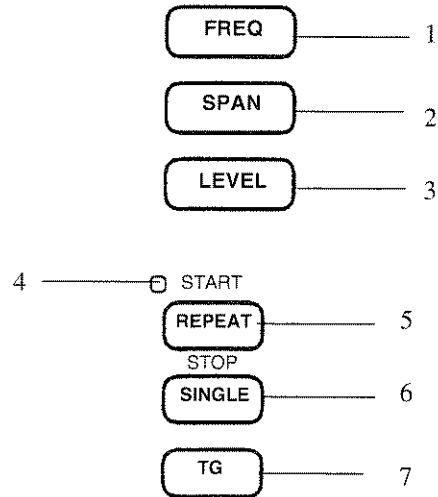

	Control	Description
1	FREQ key	Used to set center frequencies
2	SPAN key	Used to set frequency spans
3	LEVEL key	Used to set the reference level
4	SWEEP lamp	Turns on when a sweep is being performed
5	REPEAT (START/STOP) key	Used to execute continuous sweeps or to reset a sweep
6	SINGLE key	Used to execute single sweeps or to reset a sweep
7	TG key	(Option) Used to control tracking generator output

2.1.1 Front Panel

(5) DATA Section

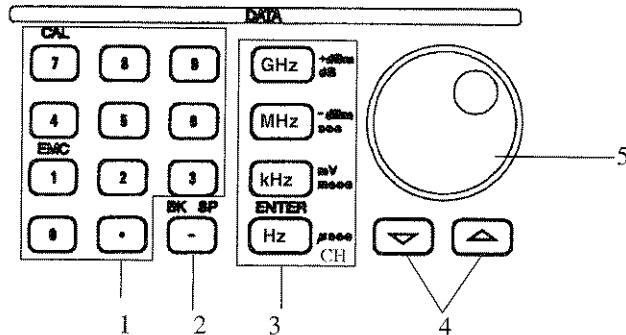

Control		Description
1	Numeric keys (additional function keys) EMC CAL	There are ten number keys (0 through 9) and a decimal point key. You can access additional functions by pressing the SHIFT key Used to set up the conditions for an EMC measurement Displays the Cal menu
2	-(BK SP) key	Used to remove data you have entered or to enter a minus(-) sign
3	Units keys GHz key MHz key kHz key Hz (ENTER) key	These are used to select a unit and enter a value Sets GHz, + dBm or dB Sets MHz, - dBm, sec, V or W Sets kHz, mV, msec or mW Sets Hz, µsec, CH, µV or µW This key is also used to specify the channel and as a general ENTER key
4	Step keys	Used to enter data in steps
5	Data knob	Used to make fine adjustments when inputting data

(6) MARKER Section

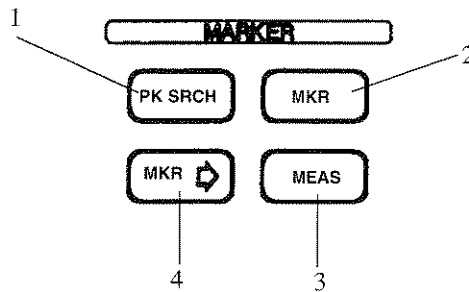

Control		Description
1	PK SRCH key	Used to search for the peak point on the trace
2	MKR key	Used to display the marker
3	MEAS key	Used to set the measurement mode
4	MKR → key	Used to obtain marker values so that they can be used as data for other functions

(7) CONTROL Section

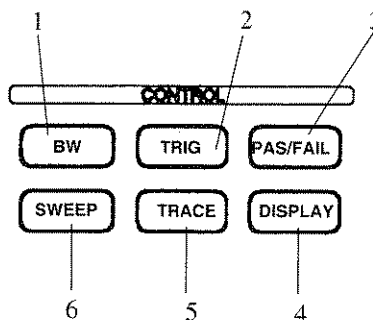

Control		Description
1	BW key	Used to set the resolution bandwidth (RBW) and video bandwidth (VBW)
2	TRIG key	Used to set the trigger conditions
3	PAS/FAIL key	Used to set the conditions in the limit line and check if those conditions have been met
4	DISPLAY key	Used to set the display line, the reference line, etc.
5	TRACE key	Used to set the trace function
6	SWEEP key	Used to set the sweep time

2.1.1 Front Panel

(8) SYSTEM Section

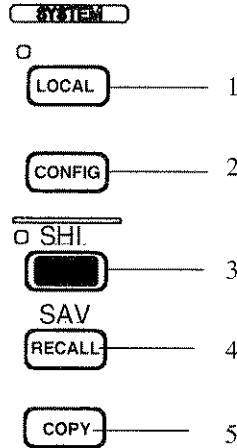

	Control	Description
1	LOCAL key REMOTE lamp	Used to disengage GPIB remote control Indicates the spectrum analyzer is in Remote mode when lit
2	CONFIG key PRESET key (SHIFT, CONFIG)	Used to set the operational conditions for the interface, etc. Used to reset the spectrum analyzer to the factory default settings
3	SHIFT key	Allows you to access additional functions for certain keys (keys that have labels in blue above them). The LED lamp next to the key turns on when SHIFT is pressed.
4	RECALL key SAVE key (SHIFT, RECALL)	Used to recall previous data Used to save data
5	COPY key	Used to obtain a hard copy of the screen data

(9) Miscellaneous Section

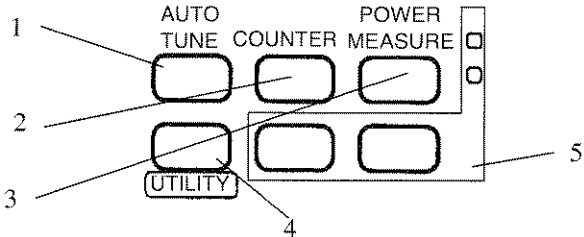

Control		Description
1	AUTO TUNE key	Used to automatically display the maximum peak
2	COUNTER key	Used to measure frequency as a counter
3	POWER MEASURE key	Used to make power measurements
4	UTILITY key	Used to set the measurement mode for the option
5		(Unused)

2.1.2 Screen Annotation

2.1.2 Screen Annotation

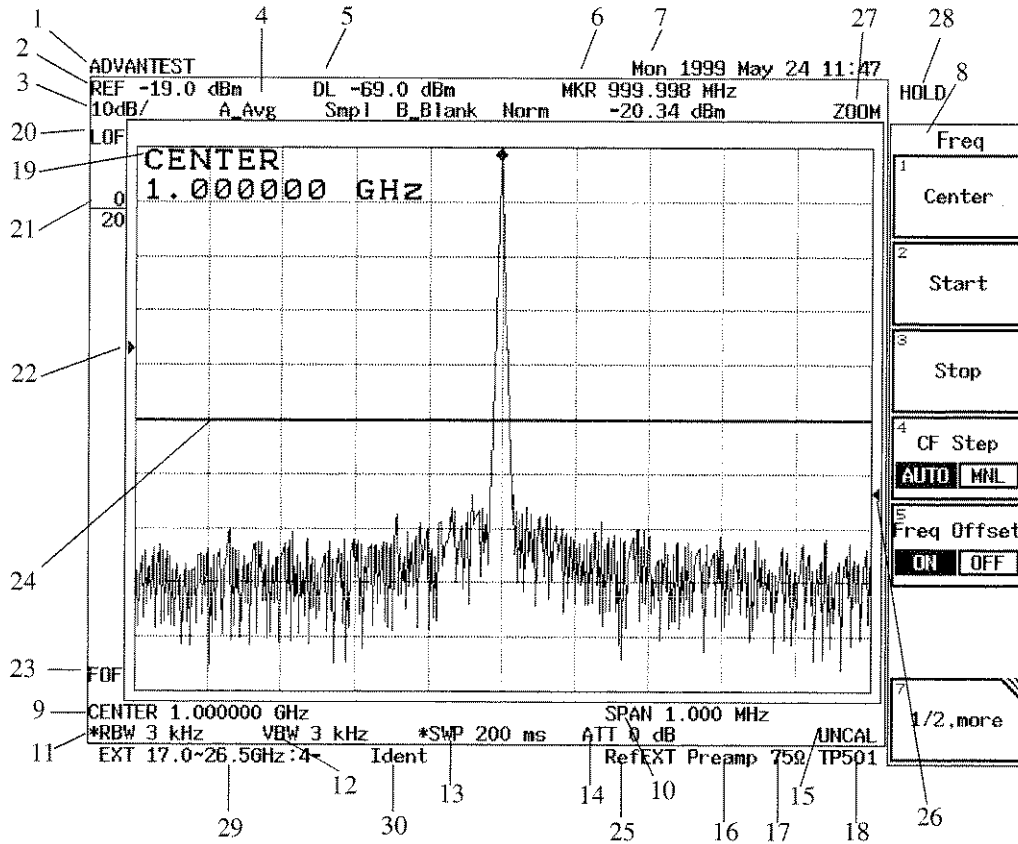

Figure 2-4 Screen Annotation

Annotation	Description
1 Title	Displays the title you have entered to distinguish the current data from other data
2 Reference level	Current reference level
3 Amplitude scale	Current amplitude scale graduation
4 Trace	Trace mode and search mode which are currently selected
5 Line setup display	Shows values for the display line
6 Marker area	Frequency and level of a marker
7 Date	Current date and time
8 Soft-menu	Menu item corresponding to the soft key
9 Center frequency or Start frequency	Indicates the frequency at the center of the current display

	Annotation	Description
10	Frequency span or Stop frequency	Frequency span of the current display (displays may differ depending on the currently active function)
11	Resolution bandwidth (RBW)	Displays the current resolution bandwidth (RBW is preceded by an asterisk (*) when set in manual mode)
12	Video bandwidth (VBW)	Frequency selected for the video bandwidth filter. VBW value is preceded by an asterisk (*) when set in manual mode.
13	Sweep time	Time required to make a single sweep. SWP is preceded by an asterisk (*) when set in manual mode
14	RF attenuator	Current attenuator level. ATT is preceded by an asterisk (*) when set in the manual mode
15	UNCAL message	Indicates that the measurement has not been calibrated
16	Preamplifier indication	Indicates that Preamp is using.
17	75Ω mode indicator	Indicates that the input impedance is 75Ω (nothing is displayed if the input impedance is 50Ω).
18	Trace point indication	Indicates that the trace points are 501 points (nothing is displayed if the trace points are 1001 points).
19	Active area	Used to display the currently active functions (note that the data can be changed) and their related values
20	Level offset	Displayed when Level Offset is toggled on.
21	Average times	Indicates the number of sweep cycles and the current number of times frequencies has been swept.
22	Video and external trigger levels	Indicates the current trigger level.
23	Frequency offset	Displayed when Frequency Offset is toggled on.
24	Display Line	Indicates the current display line.
25	10MHz External	Displayed when the external 10-MHz signal is used as the reference signal.
26	Squelch level	Indicates the level where the voice is demodulated.
27	Multi-screen mode	ZOOM, F/T, T/T, ACP, GATE or FMLN(OPT73) is displayed in Multi-screen mode.
28	HOLD mode	Indicates that panel keys are locked in the HOLD mode.
29	External mixer mode setting display	Displays frequency ranges, harmonic orders and harmonic polarities.
30	Signal identification function display	Displays whether the Signal Identification function (Ident) or Software Image Suppression function (Suppr) is turned on.

2.1.3 Rear Panel

2.1.3 Rear Panel

This subsection shows the rear panel and describes its terminals and connectors.

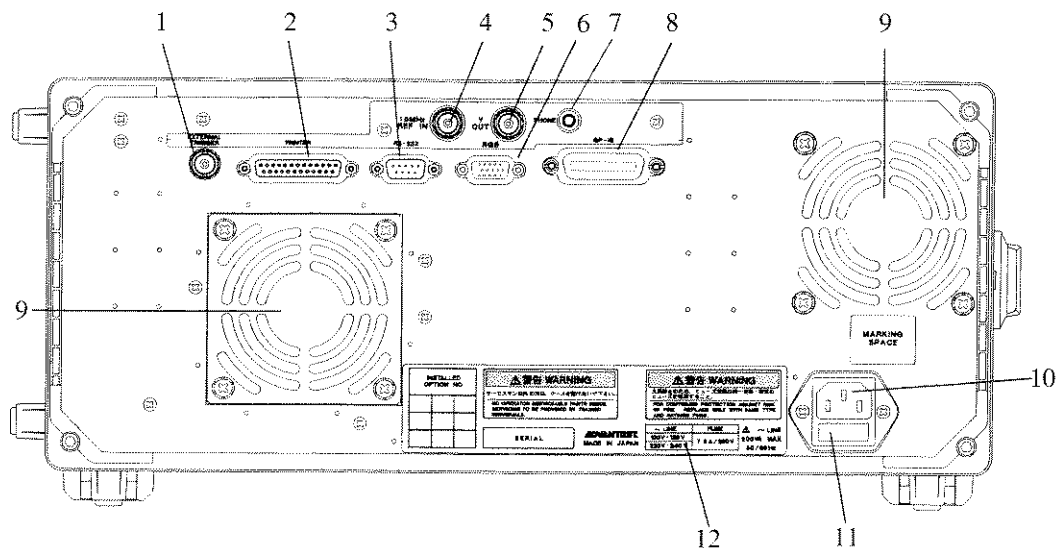

Figure 2-5 Rear Panel

Control	Description
1 EXTERNAL TRIGGER terminal	The input impedance is approximately 10 k Ω . The R3132 and R3162 start sweeping frequencies when the input signal rises or trails. (The timing is selectable.) This signal can be used as the gated sweep signal source.
2 PRINTER connector	Connector used when attaching a Centronix printer
3 RS-232 connector	Connector for an external unit used to control the spectrum analyzer through an RS-232 interface
4 10 MHz REFERENCE INPUT terminal	Input terminal for 10 MHz reference frequency signal Input impedance: Approximately 500 Ω Input level: -10 dBm to +10 dBm
5 Y-OUT terminal	10 dB/div Y signal output
6 RGB connector	Connector for an external monitor compatible with VGA specifications.
7 PHONE connector	Connector for an 8 Ω earphone used for AM/FM demodulated audio output
8 GPIB connector	Connector for an external controller cable

Control		Description
9	Exhaust vent	Used to vent excess heat buildup in the spectrum analyzer <hr/> CAUTION: Do not block this vent <hr/>
10	AC power connector	3-pin type
11	Fuse holder	Holds the line fuse and one spare fuse which is supplied with the spectrum analyzer
12	Fuse information	Lists the line voltages and fuse requirements

2.2 Basic Operation

2.2.1 Operating Menus and Entering Data

You use panel keys and soft keys to operate the spectrum analyzer. When you press a panel key, a menu is usually displayed on the right side of the screen. However, there are some keys, such as **AUTO TUNE** and **COPY**, which do not have an associated soft menu.

Each menu selection is aligned with a soft key. To make a menu selection, press the associated soft key. In some cases, pressing the soft key displays additional selections. The following example shows how the panel and soft keys function.

(1) Selecting the Menu

Press **LEVEL** to display the menu used for setting up a measurement.

A reference level value is displayed in the active area, and the Level menu is displayed on the right side of the screen as shown below.

```
Ref Level  
ATT AUTO/MNL  
dB/div  
Linear  
Units  
Hi Sens ON/OFF  
1/2_more
```

(2) Entering Data

When a value is displayed in the active area, you can change it using the numeric keys, the step keys, or the data knob.

- Entering Data Using the Numeric Keys

You use the following keys to enter data: the number keys (0 through 9), the decimal point key, and the backspace (**BK SP**) or minus (-) key. If you make a mistake when using the numeric keys, you can use the backspace (**BK SP**) key to delete the last digit entered. If you have not entered any data, pressing the **BK SP** key enters a minus (-) sign. After entering the data, pressing the **ENTER** key or one of the other unit keys completes the operation.

NOTE: *Data entered with the numeric keys that is not terminated with a units terminator is aborted when you press any panel key.*

In addition, there is a possibility that displayed data may have a unit different from that of the value entered resulting in the displayed number being different from the number entered even though the two values are the same.

Example: The following example sets the reference level to -20 dBm using the numeric keys:
Press the **-, 2, 0 and GHz(+dBm)** keys or the **2, 0 and MHz(-dBm)** keys.

- Entering Data Using the Step Keys

The step keys are used to enter data by a predefined step size. Press the ▼ step key to decrement the data; press the ▲ step key to increment the data. You can enter data while looking at the active area on the screen using the step keys.

Example: The following example sets the reference level to 0.0 dBm using the step keys:

Press the ▼ step key. This sets the reference level to -10.0 dBm. If you press the ▲ step key once more, the level is set to 0.0 dBm.

- Entering Data Using the Data Knob

The data knob is used to enter data in units of predefined display resolution. This is convenient when making fine adjustments to data which has already been entered.

Example: To set the reference level to 0.5 dBm using the data knob, turn the knob clockwise.

This increases the reference level in increments of 0.1 dBm.

Continue to turn it until the indication in the active area is 0.5 dBm.

Turning the data knob counter clockwise decreases the reference level.

- ACTIVE OFF

Pressing **ACTIVE OFF** turns off the active area and removes any information displayed. You cannot enter data if the active area is off. To turn the active area on again, press any panel or soft key.

(3) Menu structure

You can access the following submenu by pressing either *1/2_more* or the soft key with a mark in the right-hand corner.

In addition, there is another type of soft key which is used to toggle between two settings (ON/OFF, AUTO/MNL etc.). The current setting is displayed with a red box around it.

Pressing **MKR** displays the Marker menu as shown below.

Normal
Delta
Peak Menu
Sig Track ON/OFF
MKR Trace A/B
Marker OFF
1/2_more

- Displaying submenus

Pressing the soft key with a mark in the right-hand corner displays a submenu as shown below. Press *Peak Menu*. The following Peak menu is displayed.

Next Peak
Next Peak Left
Next Peak Right
Next Peak Max-Min
Min Peak
Cont Peak ON/OFF
1/2_more

- Switching between settings

To switch the currently active setting for soft keys such as AUTO/MNL, press the key. Pressing the key again changes back the setting. A selected item and an unselected item are displayed in white characters and black characters, respectively.

Example: Press *Cont Peak ON/OFF*.

ON is selected to execute marker peak search for each sweep. Press the Cont Peak again to return to OFF.

2.2.1 Operating Menus and Entering Data

- RETURN
Used to go back to displaying the Marker menu.
Press **RETURN** to return from the submenu to the original menu.
- 1/2_more and 2/2_more
Pressing *1/2_more* shows the rest of the soft key menu (those items not currently visible). Likewise, pressing *2/2_more* at the bottom of this display returns to the top of the soft key display (the previous set of items).
Press *1/2_more*. The rest of the Marker menu (menu 2), is displayed as shown below.
Fixed MKR ON/OFF
MKR Step AUTO/MNL
Multi Marker
2/2_more

Press *2/2_more*. The previous items (menu 1) are displayed.

(4) Using SHIFT

SHIFT is used to select the functions that are labeled in blue above the panel keys. There are four such functions:

- PRESET
- SAVE
- CAL
- EMC

To select one of these functions, press **SHIFT** and the desired panel key. Pressing **SHIFT** lights the adjacent LED indicating that the Shift function is active. To cancel the shift function before selecting a blue-labeled function, press **SHIFT** a second time. The green LED goes off, indicating that the Shift function is no longer active. **SHIFT** is also used to activate the hold function which disables the data knob: the hold function is activated when you press **SHIFT** until the green LED goes off. When you want to disable the hold function, repeat the above procedure; when the LED goes off, the hold function has been reset.

(5) Dialog boxes

Pressing some soft keys will display a dialog box. One or more of the following operations may be required.

- To select items
Use the data knob to select items.
- To select conditions
Use the step keys to select conditions, then press the corresponding unit (ENTER) keys to set them.
- To enter numeric values
Use the numeric keys and the corresponding unit keys.
- To close the dialog box
Press the same key that was used to open the dialog box again.

2.2.2 Displaying Spectrums and Operating the Markers

As an example, the procedure for measuring the difference between calibration signal level and secondary harmonic signal level is explained below.

Power on

NOTE: *To take accurate measurements, use the spectrum analyzer within the specified temperature range, and wait at least 30 minutes after turning the power on before using it. For these practice examples, you do not need to warm up the spectrum analyzer.*

1. Make sure that the **POWER** switch on the front panel is in the OFF position.
2. Connect the power cable provided to the AC power supply connector on the rear panel.

CAUTION: *To avoid damage, operate the spectrum analyzer within the specified input voltage and frequency ranges.*

3. Connect the power cable to the outlet.
4. Turn the **POWER** switch on.
When the self-test has completed, the startup screen is displayed.

NOTE: *The screen display after the power-on may differ from the one shown here due to previous settings.*

Initialization

This resets the current settings to the factory defaults.

5. Press **SHIFT**.
This activates the shift mode so that functions labeled in blue can be used.
6. Press **CONFIG(PRESET)**.
This resets all spectrum analyzer settings.

2.2.2 Displaying Spectrums and Operating the Markers

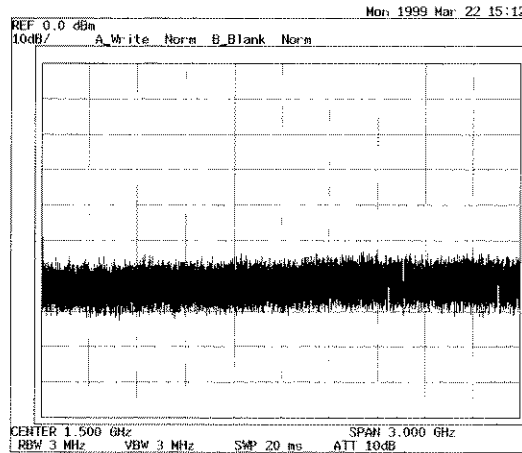

Figure 2-6 Factory Defaults Screen

Input signal connection

Connect the calibration signal used for the measurement.

7. Connect the N-BNC adapter to the INPUT connector on the front panel.
For the R3182, first connect the SMA-SMA adapter to the SMA-BNC adapter, then connect this combined adapter to the INPUT connector on the front panel.
8. Connect the INPUT connector and the CAL OUT connector on the front panel using the input cable provided as an accessory.

Setting the measurement conditions

This changes the analyzer settings so that the input signal is displayed more clearly.

9. Press **FREQ**.

The current center frequency is displayed in the active area, and the Freq menu used to select the frequency type appears on the right.

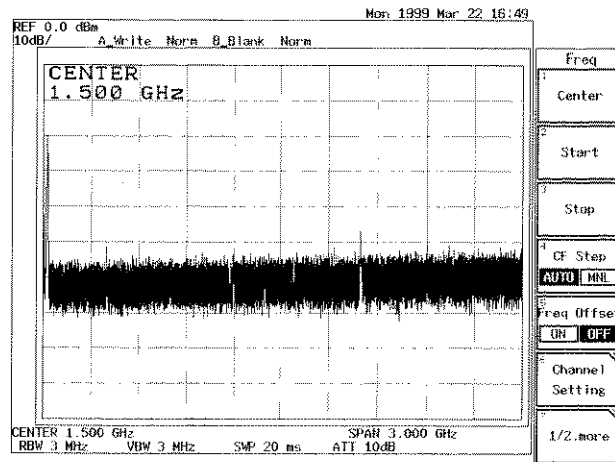

Figure 2-7 Active Area Display

10. Press **5, 0** and **MHz**.

A center frequency of 50 MHz is set.

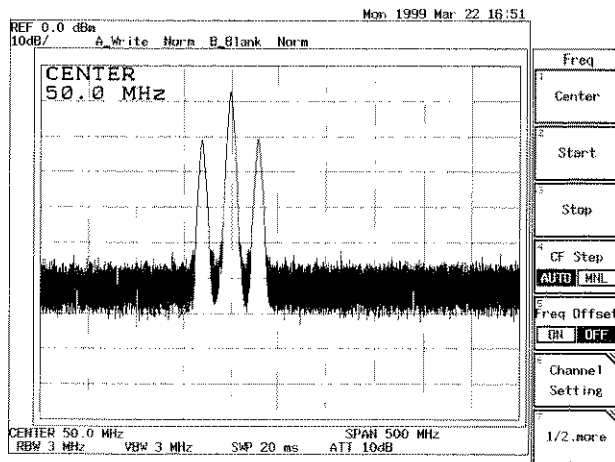

Figure 2-8 Setting the Center Frequency

11. Press **SPAN**.

The current frequency span is displayed in the active area, and the Span menu used for setting the frequency span appears on the right.

12. Press **8, 0** and **MHz**.

A frequency span of 80 MHz is set.

13. Press **LEVEL**.

The current reference level is displayed in the active area, and the Level menu used for setting the level appears on the right.

2.2.2 Displaying Spectrums and Operating the Markers

14. Press **2, 0, MHz(-dBm)**.
A reference level of -20 dBm is set.

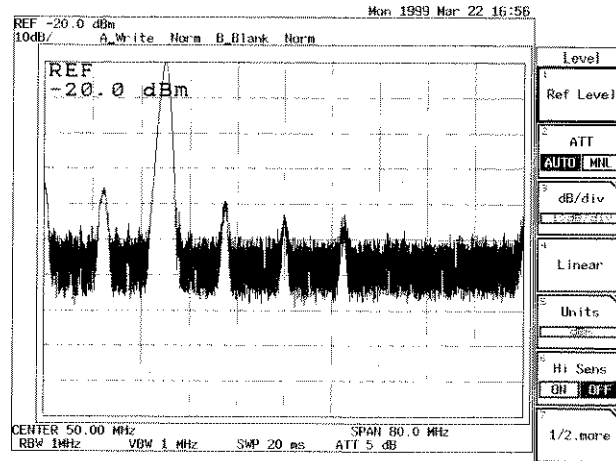

Figure 2-9 Measuring Settings Screen

Displaying a marker on the trace peak

15. Press **PK SRCH**.
The marker is displayed on the trace peak, and the marker frequency (approximately 30 MHz) and level (approximately -20 dBm) are listed in the marker area.

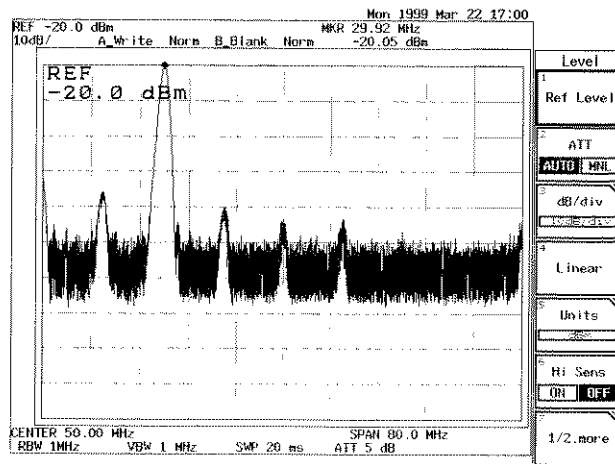

Figure 2-10 Peak Search Display Screen

Using the delta marker

16. Press **MKR**.
The Marker menu used with the marker function is displayed.
17. Press **Delta**.
The delta marker is displayed on the trace peak, and the differences between the marker and delta marker frequency and level are listed in the marker area.

2.2.2 Displaying Spectrums and Operating the Markers

18. Press **3, 0,** and **MHz(-dBm)**.

The active marker gets a secondary harmonic signal at a distance of 30 MHz.
Move the marker to the signal peak using the data knob.

The marker area displays the frequency difference and the level difference between the two signals.

2.2.3 Measuring Window and the Display Line

2.2.3 Measuring Window and the Display Line

This section describes the measuring window which is used to display measurements within a limited area, and the display and reference lines which are used to compare traces.

Power on

1. Turn the spectrum analyzer power on.

Initialization

This resets the current settings to the factory defaults.

2. Press **SHIFT** and **CONFIG(PRESET)**.
The default settings have now been reset.

Input signal connection

Connect the calibration signal used for the measurement.

Setting the measurement conditions

This changes the analyzer settings so that the input signal is displayed more clearly.

3. Press **FREQ, 3, 0** and **MHz**.
A center frequency of 30 MHz is set.
4. Press **SPAN, 5, 0** and **MHz**.
A frequency span of 50 MHz is set.
5. Press **LEVEL, 2, 0** and **MHz(-dBm)**.
A reference level of -20 dBm is set.

Activating the display line

The display line is convenient for comparing one trace level to another.

6. Press **DISPLAY** and **Disp Line ON/OFF(ON)**.
The display line is activated.
7. Move the display line vertically so that it aligns with the peak on the right side by turning the data knob.
This makes it easier to compare trace levels.

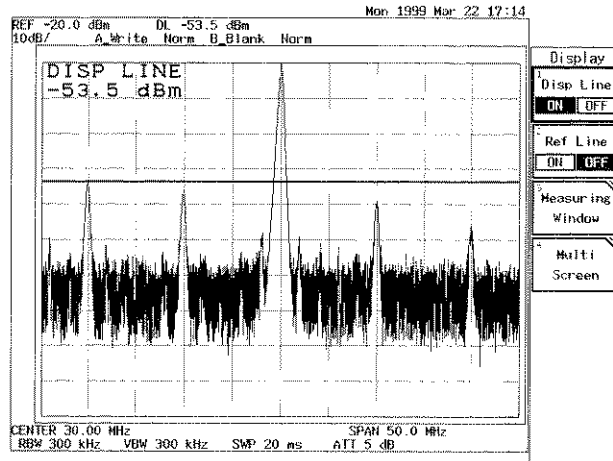

Figure 2-11 Activating the Display Line

Activating the reference line

This activates the reference line allowing you to enter reference level settings.

8. Press **Ref Line ON/OFF**(ON).
The reference line appears, and the reference level can now be set.
9. Move the reference line vertically until it is aligned with the maximum peak so that you can obtain a display line value relative to the maximum peak.

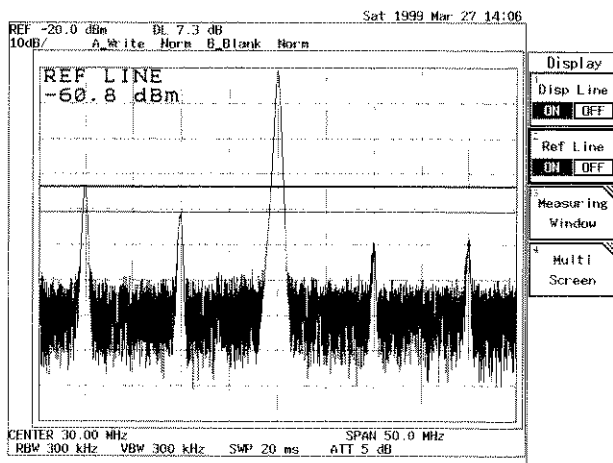

Figure 2-12 Making a Comparison Between Peaks Using Reference Lines

2.2.3 Measuring Window and the Display Line

Removing the lines

This removes the display and reference lines.

10. Press **Disp Line ON/OFF** two times.
OFF is selected and the display line is removed.
11. Press **Ref Line ON/OFF** two times.
OFF is selected and the reference line is removed.

Setting up the measuring window

12. Press **Measuring Window**.
The measuring window appears and the Window menu associated with the window settings is displayed.
The frequency for the current window position is listed in the active area, and the window position can now be changed.
13. Move the measuring window by turning the data knob so that the measuring window center is aligned with the center of the peak to the right.
14. Press **Window Width, 5, and MHz**.
The width of the measuring window is set to 5 MHz.
(The width depends on the set frequency span.)

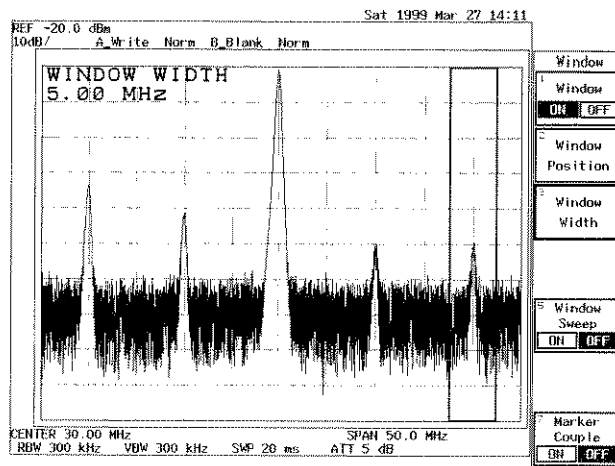

Figure 2-13 Screen Display Showing the Measuring Window

Stopping/starting a sweep within the measuring window:

15. Press **Window Sweep ON/OFF(ON)**.
The area within the measuring window is swept.
16. Press **Window Sweep ON/OFF(OFF)**.
The area within the measuring window is not swept.

Removing the window

17. Press **Window ON/OFF(OFF)**.
The measuring window is turned off.

2.2.4 Measuring Frequency Using Counter

The counter function measures the signal frequency at the marker with high accuracy. You do not have to precisely position the marker on the peak you wish to measure however you should note that the displayed amplitude value corresponds to the marker position. The maximum resolution possible for the counter function display is 1 Hz. As the resolution becomes higher, the gate time becomes longer. As a result, the sweep period becomes longer.

NOTE:

1. *The counter function may not work normally if the span is greater than 200 MHz or the difference between the marker and the noise level is 25 dB or less.*
 2. *The signal track mode cannot be used with this function.*
-

The following example shows how to measure the frequency.

Power on

1. Turn the spectrum analyzer power on.

Initialization

This resets the current settings to the factory defaults.

2. Press **SHIFT** and **CONFIG(PRESET)**.
The default settings have now been reset.

Input signal connection

Connect the calibration signal used for the measurement.

Setting the measurement conditions

This changes the analyzer settings so that the input signal is displayed more clearly.

3. Press **FREQ, 3, 0** and **MHz**.
A center frequency of 30 MHz is set.
4. Press **SPAN, 5, 0** and **MHz**.
A frequency span of 50 MHz is set.

2.2.4 Measuring Frequency Using Counter

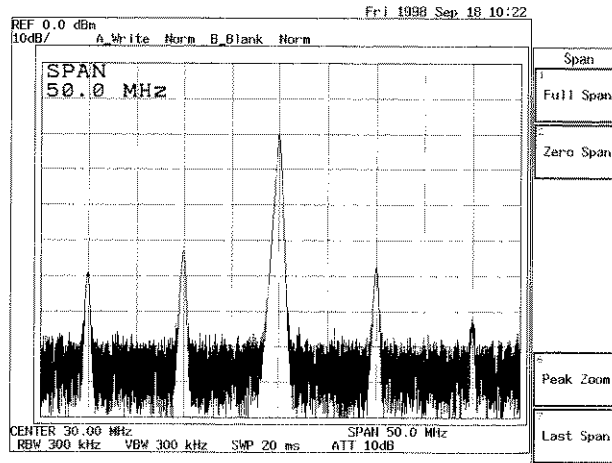

Figure 2-14 Measuring Settings Screen

Measuring frequency by counter

This measures the frequency using the counter function.

5. Press COUNTER.

The Counter menu (used for setting the frequency counter resolution) and the Frequency Counter window are displayed. The default resolution is 1 kHz.

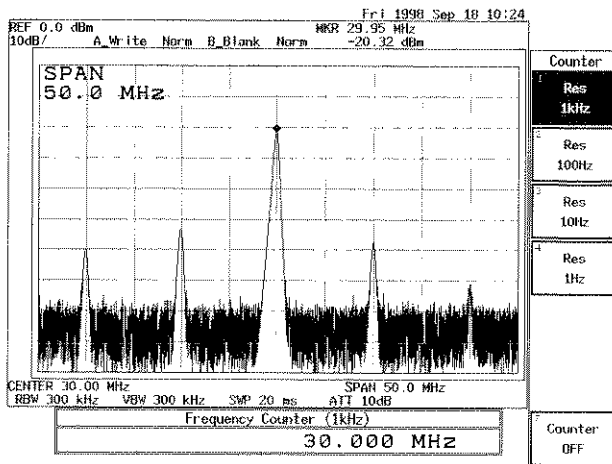

Figure 2-15 Frequency Counter Measurement (Resolution: 1 kHz)

6. Press **Res 10 Hz**.

The frequency counter resolution is set to 10 Hz and is displayed in the Frequency Counter window.

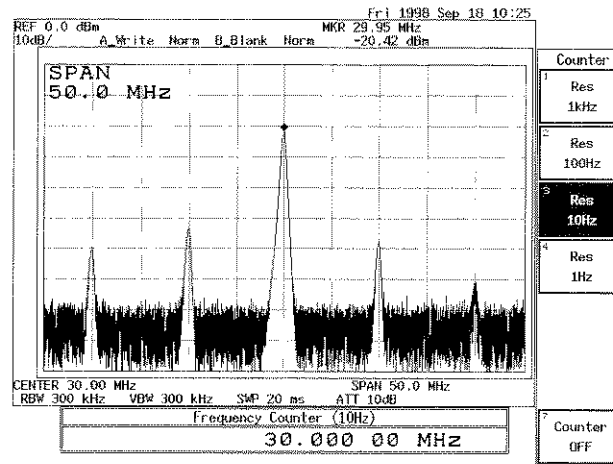

Figure 2-16 Frequency Counter Measurement (Resolution: 10 Hz)

7. Press **Counter OFF**.

The counter function is turned off.

2.2.5 Auto Tuning

You can display a signal with an unknown frequency using the auto tuning function.

Power on

1. Turn the spectrum analyzer power on.

Initialization

This resets the current settings to the factory defaults.

2. Press **SHIFT** and **CONFIG(PRESET)**.
The default settings have now been reset.

Input signal connection

Connect the calibration signal used for the measurement.

Frequency span

This sets the frequency span in preparation for auto-tuning.

3. Press **SPAN, 1** and **MHz**.
A frequency span of 1 MHz is set.

2.2.5 Auto Tuning

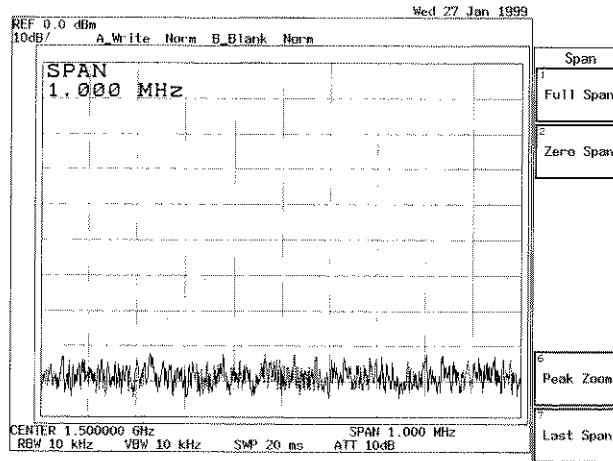

Figure 2-17 Screen Display Prior to Auto Tuning

Auto tuning

4. Press **AUTO TUNE**.

Normally, peak searches cover the entire band, and the span gradually returns to the original setting by keeping track of that peak signal. With this function, the maximum peak is automatically displayed. The reference level is set to the tuned peak level under these conditions.

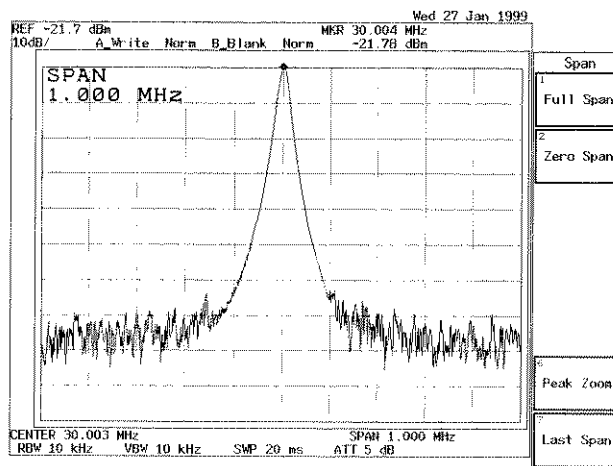

Figure 2-18 Screen Display after Auto Tuning

2.2.6 Tracking Operations

Tracking operations consist of signal tracking (which is useful for measuring a signal whose frequency is variable) and continuous peak search functions.

Power on

1. Turn the spectrum analyzer power on.

Initialization

This resets the current settings to the factory defaults.

2. Press **SHIFT** and **CONFIG(PRESET)**.
The default settings have now been reset.

Input signal connection

Connect the calibration signal used for the measurement.

Setting the measurement conditions

This changes the analyzer settings so that the input signal is displayed more clearly.

3. Press **FREQ, 2, 9, ,, 9, 9** and **MHz**.
A center frequency of 29.99 MHz is set.
4. Press **SPAN, 5, 0** and **kHz**.
A frequency span of 50 kHz is set.

Signal tracking

This function performs a peak search using a signal with the marker in each sweep, and the detected frequency is set to the center frequency. The detected peak frequency is always set as the center frequency.

5. Press **PK SRCH, MKR** and **Sig Track ON/OFF(ON)**.
Signal tracking is turned on. The detected peak frequency is always set as the center frequency even if the input signal frequency varies.

NOTE: *When the signal tracking function has been turned on and ten keys are used to change the frequency span, the auto-zooming function automatically tracks the signal and changes the frequency span until an optimum span is achieved.*

2.2.6 Tracking Operations

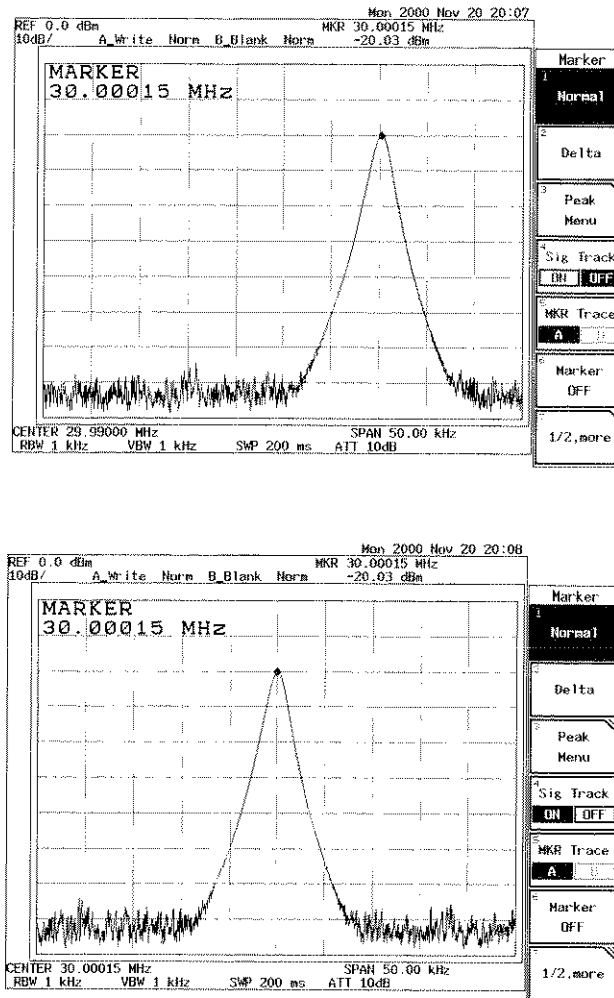

Figure 2-19 Signal Tracking Screen

6. Press *Sig Track ON/OFF*(OFF).
Signal tracking is turned off.

Continuous peak search

This function allows you to detect a peak and move the marker to the peak in each sweep. If the delta marker is being used at that time, the normal marker is displayed on the peak and the delta marker is displayed the delta frequency away from the peak (unless the zero span is set).

7. Press *Peak Menu* and *Cont Peak ON/OFF*(ON).
The Cont peak search is turned on. A peak is detected in each sweep and the marker is always moved to that peak even if the input signal frequency varies.
8. Press *Cont Peak ON/OFF*(OFF).
Continuous peak search is turned off.

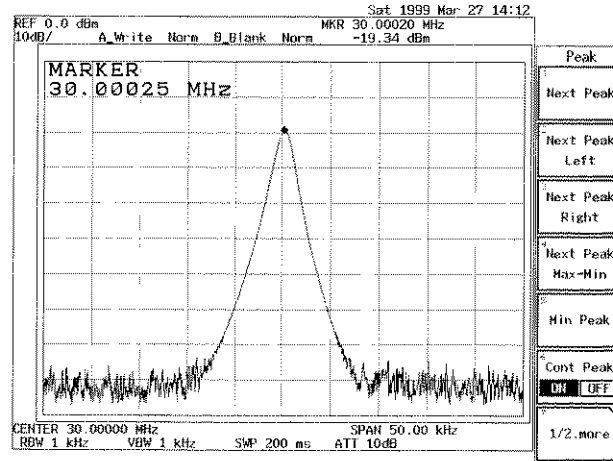

Figure 2-20 Continuous Peak Search Screen

2.2.7 UNCAL Message

The settings of the resolution bandwidth (RBW), video bandwidth (VBW), frequency span (SPAN) and sweep time (SWP) are interrelated. The message UNCAL is displayed in the lower right of the screen when any item is inappropriately set. If this happens, proceed as follows to remove the UNCAL message.

- Make the resolution bandwidth (RBW) wider.
- Make the video bandwidth (VBW) wider.
- Make the sweep time (SWP) longer.
- Make the frequency span (SPAN) narrower when the RBW or VBW cannot be changed.

CAUTION *Measured data may be inaccurate if you take measurements while the UNCAL message is displayed.*

In this section, the following example shows how to remove an UNCAL message, which was caused by making the sweep time shorter, by changing the RBW setting.

Power on

1. Turn the analyzer and the signal generator power on.

Initialization

This resets the current settings to the factory defaults or user-defined presets.

2. Press **SHIFT** and **CONFIG(PRESET)**.
This sets the analyzer to its presets values.

2.2.7 UNCAL Message

Input signal connection

Connect the calibration signal used for the measurement.

Setting the measurement conditions

3. Press **FREQ, 3, 0** and **MHz**.
A center frequency of 30 MHz is set.
4. Press **SPAN, 5, 0** and **kHz**.
A frequency span of 50 kHz is set.
The following are automatically set:
RBW = 1 kHz, VBW = 1 kHz, Sweep time = 200 ms.
5. Press **SWEEP, SWP Time AUTO/MNL(MNL), 4, 0** and **kHz(ms)**.
Sweep time is set to 40 ms and UNCAL is displayed in the lower right hand on the screen. A Sweep time of 40 msec is too short.

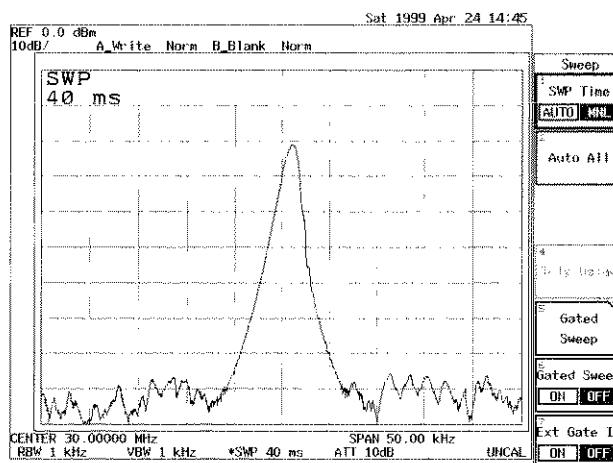

Figure 2-21 Screen with UNCAL Message

Coping with the UNCAL message

6. Press **BW, RBW AUTO/MNL(MNL), 3** and **kHz**.
Once the RBW is set to 3 kHz, the UNCAL message will disappear because a sweep time of 40 msec meets the required condition.

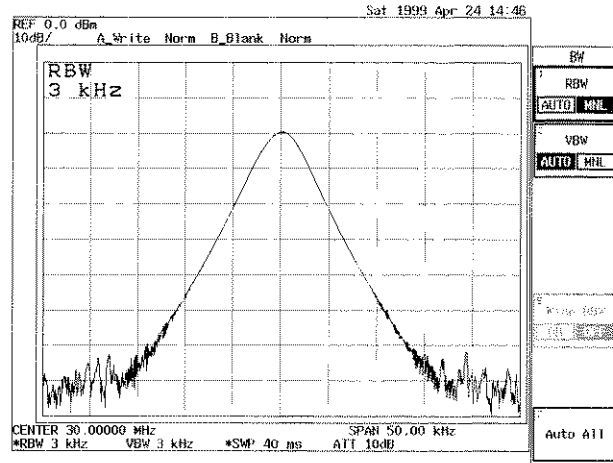

Figure 2-22 UNCAL Message Removed

2.2.8 Separating Two Signals

This section describes how RBW should be set to properly observe adjacent signals using the spectrum analyzer.

Setup

1. Connect the signal generators as shown in Figure 2-23.

R3132 Series Spectrum analyzer

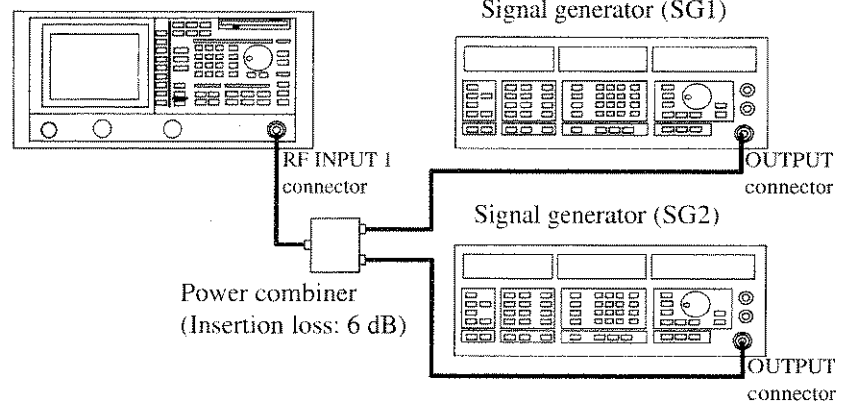

Figure 2-23 Setup for Measuring Two Signals Separately

Power on

2. Turn the power on.

2.2.8 Separating Two Signals

Setting the signal generators

This prepares the signal generators for output.

3. Set the SG1 frequency to 200.00 MHz; the SG1 level to -10 dBm; and the SG1 output to ON.
4. Set the SG2 frequency to 200.25 MHz; the SG2 level to -20 dBm; and the SG2 output to ON.

Initialization

This resets the current settings to the factory defaults.

5. Press **SHIFT** and **CONFIG(PRESET)**.
The default settings have now been reset.

Setting the measurement conditions

This changes the analyzer settings so that the input signal is displayed more clearly.

6. Press **FREQ, 2, 0, 0** and **MHz**.
A center frequency of 200 MHz is set.
7. Press **SPAN, 1, 0** and **MHz**.
A frequency span of 10 MHz is set.

The spectrums are not fully separated because the RBW default setting is 100 MHz. As a result, the display shows only one input signal even though there are actually two.

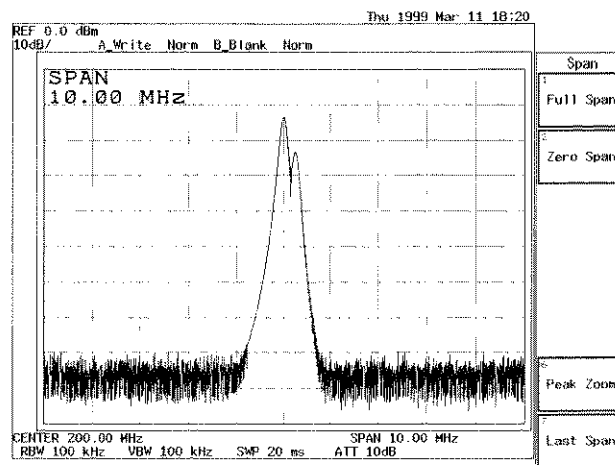

Figure 2-24 Two Superimposed Peaks

8. Press **BW, RBW AUTO/MNL(MNL), 3, 0** and **kHz**.
The RBW is set to 30 kHz.
Two peaks are now discernible but they are still not clearly separated.

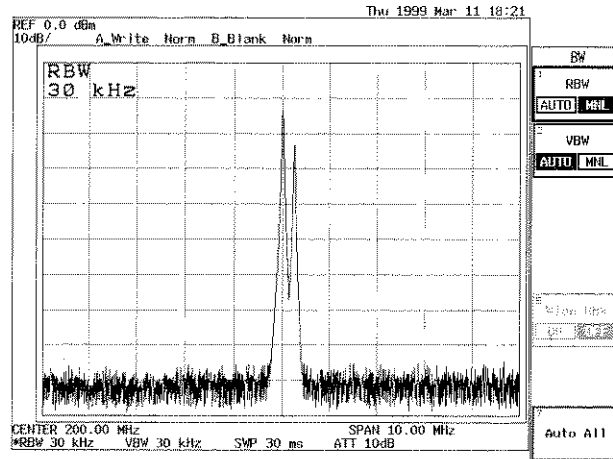

Figure 2-25 Two Discernible Peaks

9. Press 1, 0 and kHz.
The RBW is set to 10 kHz.
Two peaks can now be distinctly seen.

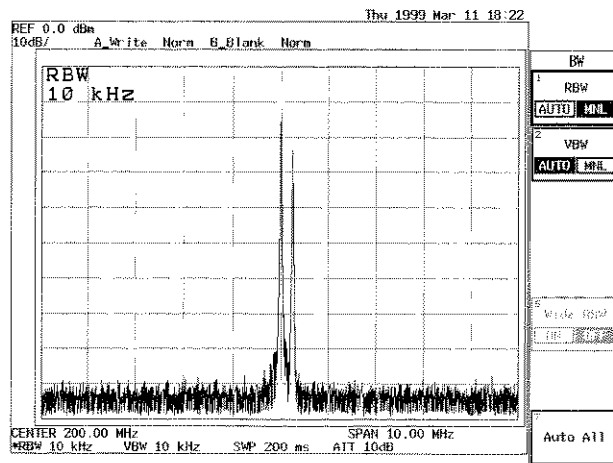

Figure 2-26 Two Distinct Peaks Can Now Be Seen

2.2.9 Measuring low level signals

2.2.9 Measuring low level signals

Reducing the noise level allows you to measure low-level signals. The noise level can be reduced by narrowing the resolution bandwidth. If the video bandwidth is set or the averaging function is used, you can observe the signals that are lost in the noise. Additionally, using the built-in pre-amplifier allows you to measure still lower level signals.

Setup

1. Connect the signal generator as shown in Figure 2-27.

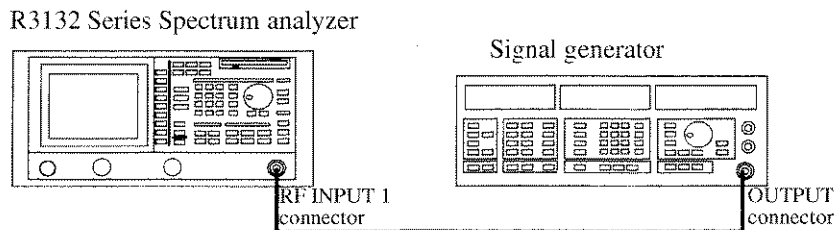

Figure 2-27 Setup for Verifying the Dynamic Range

Power on

2. Turn the power on.

Setting the signal generator

This prepares the signal generators for output.

3. Set the SG frequency to 200 MHz; the SG1 level to -80 dBm; modulation mode to non-modulated; and output to ON.

Initialization

This resets the current settings to the factory defaults

4. Press **SHIFT** and **CONFIG(PRESET)**.
The default settings have now been reset.

Setting the measurement conditions

This changes the analyzer settings so that the input signal is displayed more clearly.

5. Press **FREQ, 2, 0, 0** and **MHz**.
A center frequency of 200 MHz is set.
6. Press **SPAN, 5, 0, 0** and **kHz**.
A frequency span of 500 kHz is set.

7. Press **LEVEL, 5, 0** and **MHz(-dBm)**.
The reference level is set to -50 dBm.

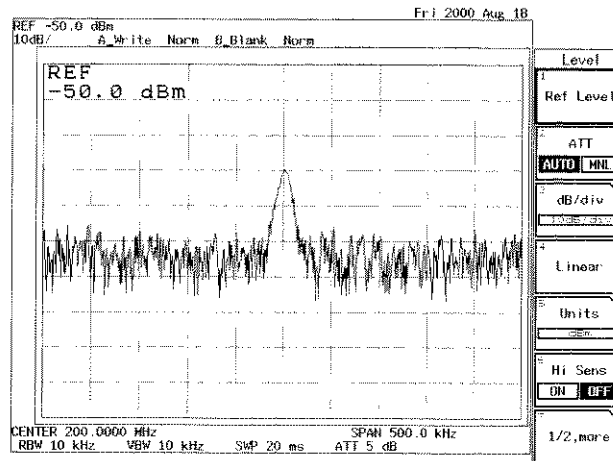

Figure 2-28 Screen Display Prior to Changing the RBW

Changing the RBW

The RBW default setting is 10 kHz. The noise level can be reduced by decreasing this value.

8. Press **BW, RBW AUTO/MNL(MNL), 1** and **kHz**.
The RBW mode is changed to manual, and the resolution bandwidth is set to 1 kHz. As a result, the dynamic range has increased and this has reduced the noise level by approximately 10 dB.

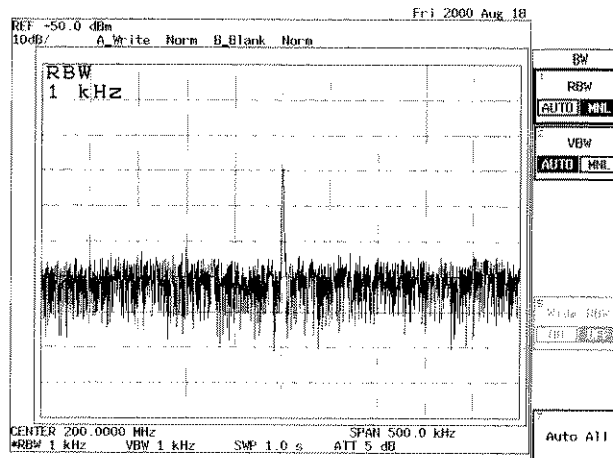

Figure 2-29 Screen Display after Changing the RBW

Changing VBW

The noise width can be further reduced by setting the VBW to 1/10 of the RBW.

2.2.9 Measuring low level signals

9. Press **VBW AUTO/MNL**(MNL), **1, 0, 0** and **Hz**.
 VBW is set to MNL, and a video resolution bandwidth of 100 Hz is entered. As a result, the noise width has been reduced.

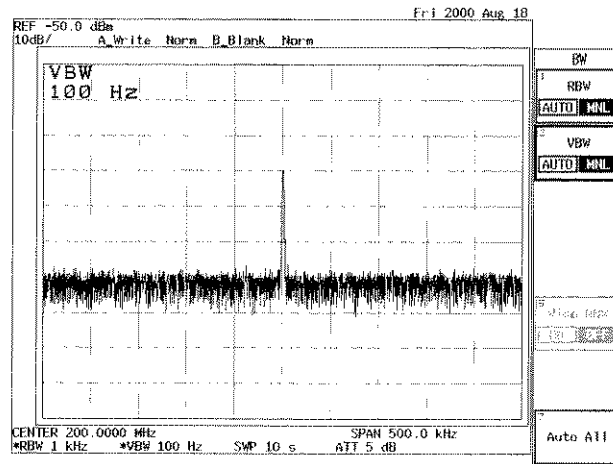

Figure 2-30 Screen Display after Changing the VBW

10. Press **BW** and **VBW AUTO/MNL**(AUTO).
 The VBW function is switched to the AUTO mode.

Performing the averaging function

This function can improve the S/N ratio faster than the VBW method shown above. This function makes it possible to quantify random components and measure signals buried in the noise.

11. Press **TRACE**, **1/2_more** and **AVG A**.
 AVG A (with a default setting of 20) has reduced the noise level considerably.

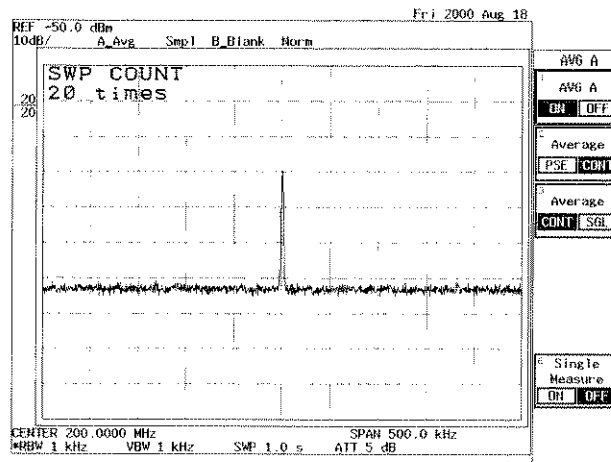

Figure 2-31 The Trace after Averaging

Built-in pre-amplifier

The analyzer include a pre-amplifier for frequency band of 3 GHz and are available for high sensitive measurements.

The averaging function is turned off, and the RBW and VBW functions are set to AUTO mode.

12. Press **AVG A ON/OFF**(OFF).
The averaging function is turned off.
13. Press **BW, RBW AUTO/MNL**(AUTO) and **VBW AUTO/MNL**(AUTO).
The RBW and VBW functions are set to AUTO mode.
14. Press **LEVEL** and **Hi Sens ON/OFF**(ON).
The noise level decreases by approximately 25 dB.

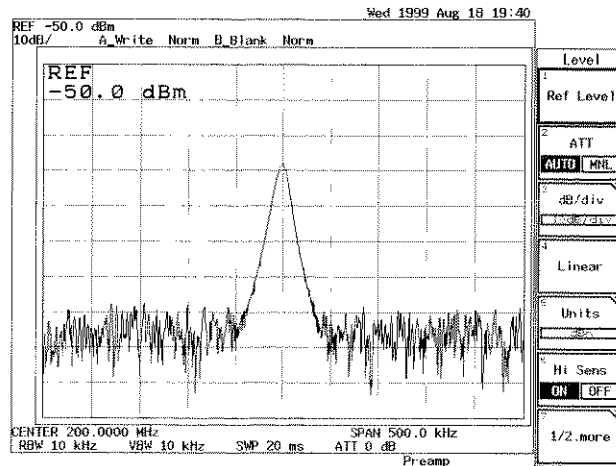

Figure 2-32 Spectrum Displayed when the pre-amplifier is Used

2.2.10 Input Saturation

2.2.10 Input Saturation

After a signal being sent to the input mixer reaches a certain level, the displayed value is not proportional to the signal input because of saturation. An input level producing a 1 db error due to saturation is defined as the gain compression. In this example, you apply two input signals and verify that an input signal whose value is less than the limit of gain compression produces less output than it would under perfect linearity. This phenomenon is caused by another input signal whose value is larger than the gain compression limit.

Setup

1. Connect the signal generators as shown in Figure 2-33.

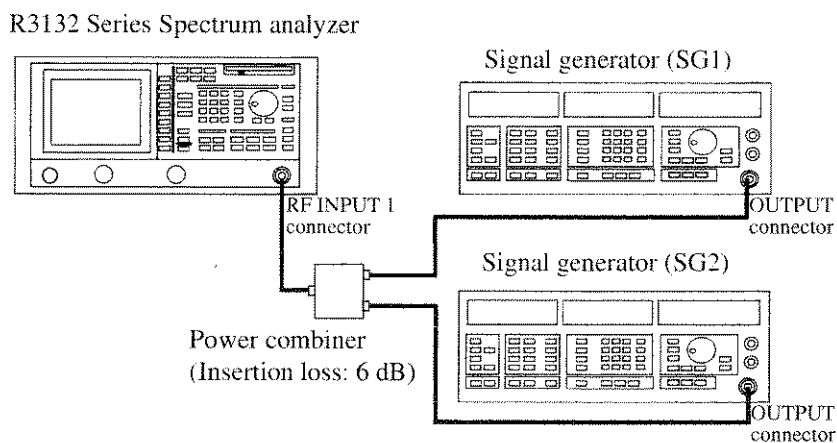

Figure 2-33 Setup for Input Saturation

Power on

2. Turn the power on.

Setting the signal generators

This prepares the signal generator outputs.

3. Set SG1 as follows: the frequency to 99.8 MHz; level to -10 dBm; modulation to non-modulated; and output to ON.
4. Set SG2 as follows: the frequency to 100.3 MHz; level to -40 dBm; modulation to non-modulated; and output to ON.

Initialization

This resets the current settings to the factory defaults.

5. Press **SHIFT** and **CONFIG(PRESET)**.
The default settings have now been reset.

Setting the measurement conditions

This changes the analyzer settings so that the input signal is displayed more clearly.

6. Press **FREQ, 1, 0, 0** and **MHz**.
A center frequency of 100 MHz is set.
7. Press **SPAN, 1** and **MHz**.
A frequency span of 1 MHz is set.
8. Press **LEVEL, ATT AUTO/MNL(MNL), 0** and **GHz(dB)**.
The Attenuator level is set to 0 dB.
Under these conditions, the input level at the mixer is -16 dBm (-16 dBm -0dB), and the measurement is correct without saturation.

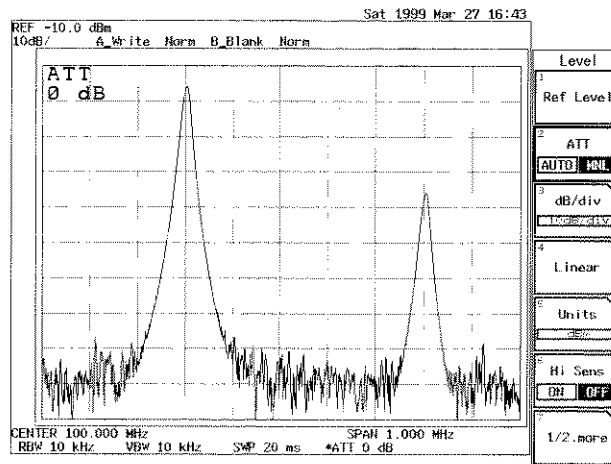

Figure 2-34 Screen Display without Saturation

Changing the input signal level

Saturation can be observed as the left side signal level is increased.

9. Set SG1 level to +10 dBm.
Under these conditions, the input level for the mixer is +4 dBm (= +4 dBm -0dB), and the right hand signal level is reduced due to saturation caused by gain compression.

2.2.11 Harmonic Distortion

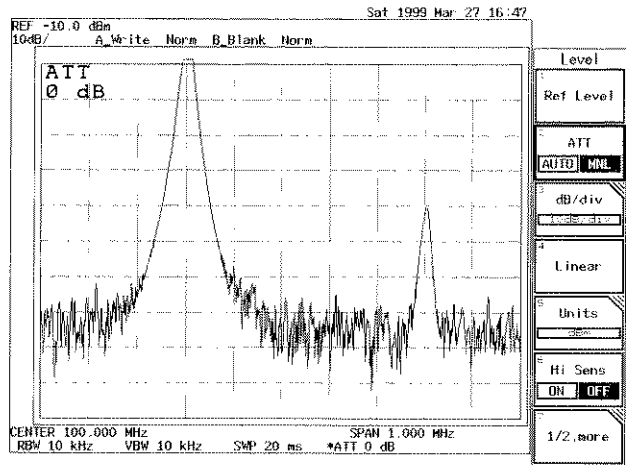

Figure 2-35 Screen Display Showing Saturation

2.2.11 Harmonic Distortion

Harmonic distortion is produced by non-linearity from the input mixer if the input exceeds a certain limit. As a result, spurious signals which do not come from the input signal may be observed.

Setup

1. Connect the signal generator as shown in Figure 2-36.

R3132 Series Spectrum analyzer

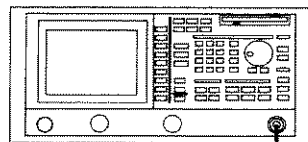

Signal generator

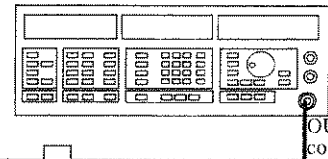

RF INPUT 1
connector

OUTPUT
connector

A lowpass filter used to reject second-order harmonics

Figure 2-36 Setup for Measuring Harmonic Distortion

Power on

2. Turn the power on.

Setting the signal generator

This prepares the signal generator output.

3. Set the frequency to 270 MHz; the level to 0 dBm; mode of modulation to non-modulated; and output to ON.

Initialization

This resets the current settings to the factory defaults.

4. Press **SHIFT** and **CONFIG(PRESET)**.
The default settings have now been reset.

Setting the measurement conditions

This changes the analyzer settings so that the input signal is displayed more clearly.

5. Press **FREQ, 3, 5, 0** and **MHz**.
A center frequency of 350 MHz is set.
6. Press **SPAN, 5, 0, 0** and **MHz**.
A frequency span of 500 MHz is set.
7. Press **BW, RBW AUTO/MNL(MNL), 1, 0, kHz, VBW AUTO/MNL(MNL), 1** and **kHz**.
An RBW of 10 kHz is set, and a VBW of 1 kHz is set.

Verifying harmonic distortion

8. Confirm that harmonic distortion is occurring on the right hand side of the screen.
When the attenuator is set to 10 dB (default setting), and the mixer input is -10 dBm (= 0 dBm - 10 dB), harmonic distortion occurs.

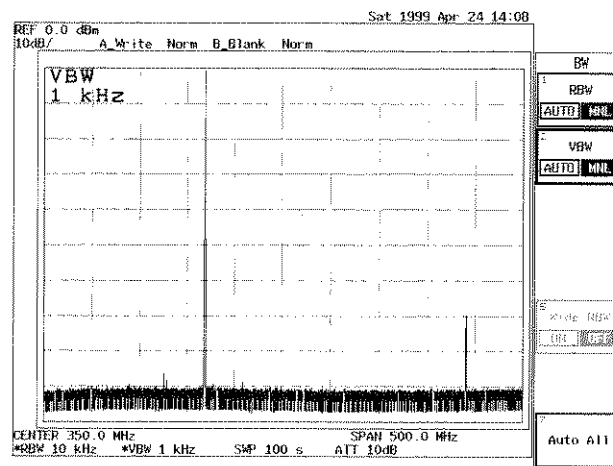

Figure 2-37 Screen Display Showing Harmonic Distortion

2.2.12 Intermodulation

- Press **LEVEL**, **ATT AUTO/MNL(MNL)**, **2, 0** and **GHz(dB)**.
The attenuator level is set to 20 dB.

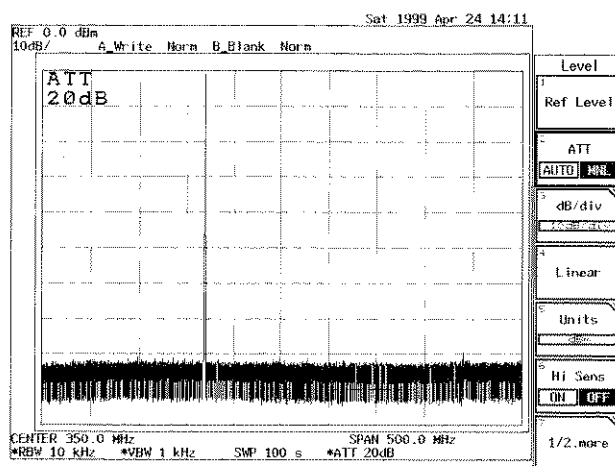

Figure 2-38 Screen Display Showing Reduced Harmonic Distortion

The input to the mixer becomes -20 dB, and the secondary harmonic distortion generated in the spectrum analyzer decreases by 10 dB.

2.2.12 Intermodulation

This section describes how to set up the attenuator (ATT) when using a spectrum analyzer which is receiving more than one input signal.

When signals with an excess amplitude are input, spurious signals produced by intermodulation are displayed. It is important that the ATT be adjusted to moderate the mixer input.

Setup

- Connect the signal generators as shown in Figure 2-39.

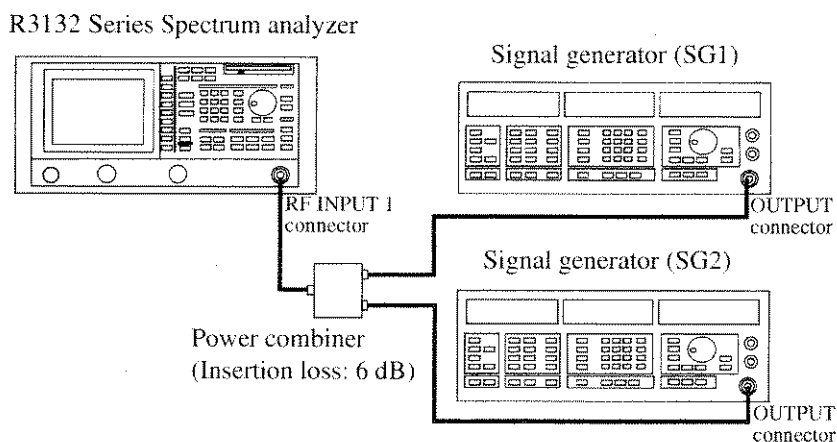

Figure 2-39 Setup for Measuring Intermodulation

Power on

2. Turn the power on.

Setting the signal generators

This prepares the signal generator outputs.

3. Set SG1 as follows: the frequency to 200.0 MHz; level to -4 dBm; modulation to non-modulated mode; and output to ON.
4. Set SG2 as follows: the frequency to 200.2 MHz; level to -4 dBm; modulation to non-modulated mode; and output to ON.
Each signal has an input level of -10 dBm.

Initialization

This resets the current settings to the factory defaults.

5. Press **SHIFT** and **CONFIG(PRESET)**.
The default settings have now been reset.

Setting the measurement conditions

This changes the analyzer settings so that the input signal is displayed more clearly.

6. Press **FREQ, 2, 0, 0** and **MHz**.
A center frequency of 200 MHz is set.
7. Press **SPAN, 1** and **MHz**.
A frequency span of 1 MHz is set.
8. Press **BW, RBW AUTO/MNL(MNL), 3** and **kHz**.
The RBW is set to 3 kHz.
9. Press **VBW AUTO/MNL(MNL), 3, 0, 0** and **Hz**.
The VBW is set to 300Hz.
The attenuator level default setting is 10 dB, which makes the input to the mixer -20 dBm (= -10 dBm - 10 dBm). Since the mixer level exceeds the distortion limit, spurious peaks (3 and 4) appear in addition to the normal peaks (1 and 2).

2.2.12 Intermodulation

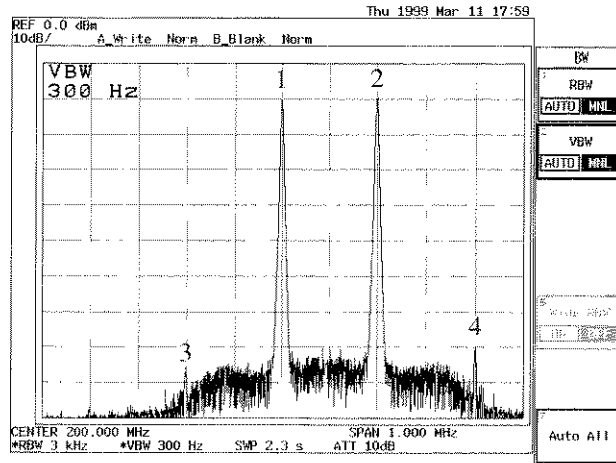

Figure 2-40 Screen Display Showing Intermodulation Distortion

Changing the attenuator

10. Press **LEVEL**, **ATT AUTO/MNL(MNL)**, **2, 0** and **GHz(dB)**.
The attenuator level is set to 20 dB.
Under these conditions, the mixer input level is -30 dBm (= -10 dBm - 20 dB),
and spurious peaks (peaks 3 and 4 in Figure 2-40) are not produced.

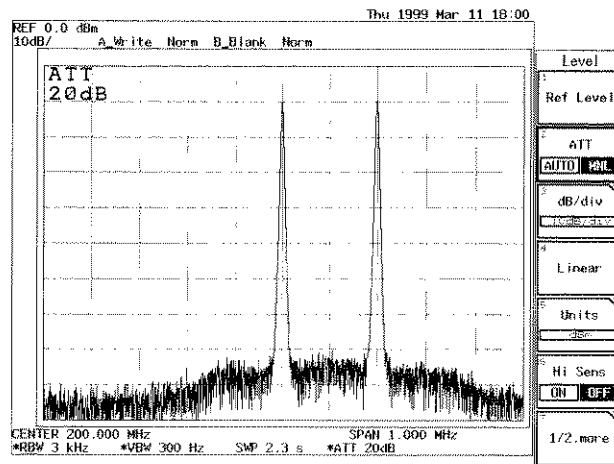

Figure 2-41 Screen Display without Intermodulation Distortion

The current spectrum has no intermodulation distortion. It is important that the ATT be adjusted in order to moderate the mixer input when using more than one input.

2.2.13 Calibration

Wait at least 30 minutes after turning on the spectrum analyzer before attempting to perform any measurements, or the measurements may not be accurate.

Set up

Connecting the calibration signal.

1. Connect the N-BNC adapter to the INPUT connector on the front panel.
For the R3182, first connect the SMA-SMA adapter to the SMA-BNC adapter, then connect this combined adapter to the INPUT connector on the front panel.
2. Connect the INPUT connector and the CAL OUT connector on the front panel using the input cable provided as an accessory.

Performing the calibration

3. Press **SHIFT** and **7(CAL)**.
The Cal menu used for calibration appears.

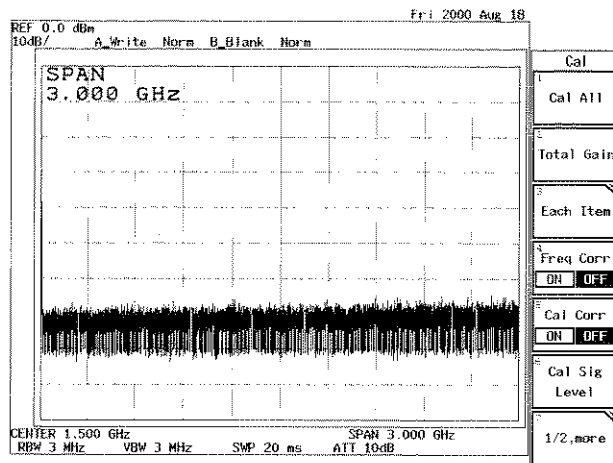

Figure 2-42 Screen Display Showing the Cal Menu

4. Press **Cal All**.
Calibrates the spectrum analyzer. After all calibration items have been completed, the spectrum analyzer enters the error correction mode. Press **Each Item**, then select an item you wish to calibrate.

NOTE: You may hear some clicking noises during calibration, but this is normal.

2.2.14 Entering User-definable Antenna Correction Data

You can define your own antenna correction data in addition to the four regular types of antenna correction data. This section describes how to do this.

Creating a correction data table

Save an empty correction data table to a floppy disk using the following procedure.

2.2.14 Entering User-definable Antenna Correction Data

1. Insert the floppy disk in the disk drive.
2. Press **SHIFT** and **RECALL(SAVE)**.
The Save menu and file list are displayed.
3. Press *Device RAM/FD* to select FD.
The floppy disk is selected as the destination for the data table.
4. Press *Save Item*.
The Save Item menu used for selecting data is displayed
5. Set *Ant Corr* to ON in the Save Item menu (do not turn any other settings on).
6. Press **Save Item**.
The empty correction data table is saved to the floppy disk.
7. Specify the file, and press *Save*.
This copies the empty correction data table to the floppy disk.

Editing the correction data table

The correction data table can be edited using a personal computer.

8. Open the data in the folder SVRCL on the floppy disk.
9. Add the data for frequency (Hz) and correction (dB) after the row <ANT CORR>.

	A	B	C
1	ADVANTEST	R3162	
2	DATE	1999/3/18 13:55	
3	TITLE	*	
4	SYSTEM	062X00	
5	TYPE		0
6	SERIES		1
7	SKIND		8
8			
9	<ANT CORR>		
10	500000000		-45
11	800000000		-35
12	1000000000		-15
13	1200000000		-5
14	1400000000		0
15			

Figure 2-43 Editing the Correction Data Table

10. Save the data to the floppy disk in text data format.

Importing the correction data table

This reads the edited correction data table into the spectrum analyzer.

2.2.14 Entering User-definable Antenna Correction Data

11. Press **RECALL**.
The Recall menu used and the file list are displayed.
12. Press *Device RAM/FD* to specify FD.
Floppy disk is selected.
13. Select the file and press *Recall*.
The correction data table is read out.

Verifying the imported correction data table

This confirms that the correction data table has been read into the spectrum analyzer.

14. Press **SHIFT** and **1(EMC)**.
The EMC menu is displayed.

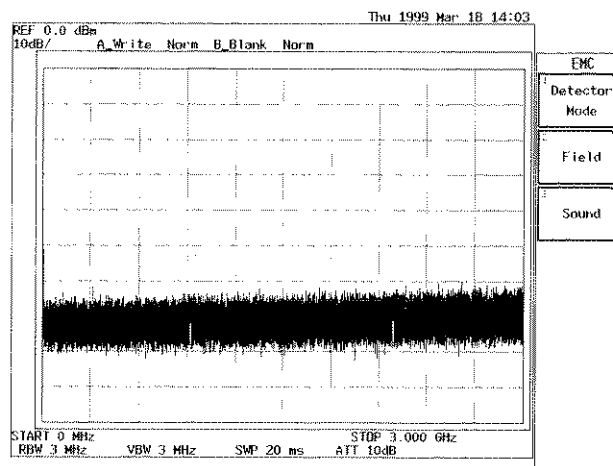

Figure 2-44 Screen for the EMC Menu

15. Press *Field, User ANT Corr*.
The edited data in the correction data table is displayed.

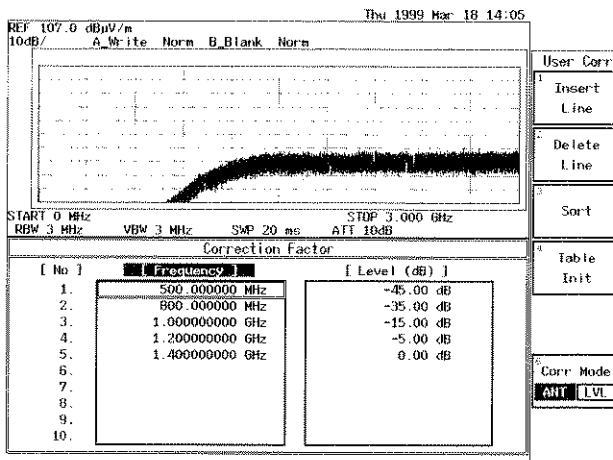

Figure 2-45 Screen Display Showing the User-Definable Correction Data Table

2.2.15 External Mixer (OPT16 thru OPT19)

2.2.15 External Mixer (OPT16 thru OPT19)

The external mixers WHMB-28S (OPT16), WHMB-19S (OPT17), WHMB-15S (OPT18) and WHMB-10S (OPT19) are used to analyze frequencies together with an R3172/82 and an external waveguide mixer. The R3172/82 is used to analyze frequencies in one of the input ranges shown below.

Table 2-1 Product Summary

OPT No.	Frequency range	External mixer used
OPT16	26.5 to 40 GHz	WHMB-28S
OPT17	40 to 60 GHz	WHMB-19S
OPT18	50 to 75 GHz	WHMB-15S
	70 to 80 GHz	
OPT19	75 to 110 GHz	WHMB-10S

These options are provided with a floppy disk drive. Level correction data can be saved to a floppy so that it can be loaded automatically before using the spectrum analyzer.

CAUTION To install the mixer option on the R3172, OPT 03 (Local output to an external mixer) must be provided separately.

The configuration of the options is shown below.

Table 2-2 Configuration of the Options

Name	Model	Qty	Remarks
Waveguide mixer	For OPT16	WHMB-28S	1
	For OPT17	WHMB-19S	
	For OPT18	WHMB-15S	
	For OPT19	WHMB-10S	
Connection cable		1	SMA cable
Floppy disk		1	Contains level correction values

This section explains how to set up the R3172/82 and waveguide mixer, and how to operate them.

Setup

CAUTION:

1. When connecting the R3172/82 to the waveguide mixer, be sure to connect the cable to the EXT MIXER connector on the R3172/82, and then the other side of the cable to the waveguide mixer.
An internal diode in the mixer may be damaged due to piezoelectricity voltage generated in the cable.
 2. The maximum allowable input level to the waveguide mixer is +20 dBm. If the input level exceeds this value, insert an attenuator into the input.
-

1. Connect one end of the cable to the EXT MIXER connector on the R3172/82.
2. Connect the other end of the cable to the Lo input connector on the waveguide mixer.

R3172 Spectrum analyzer

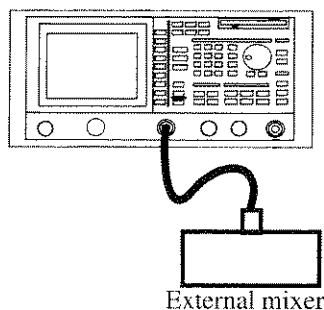

Figure 2-46 Setup for the R3172 and Waveguide Mixer

R3182 Spectrum analyzer

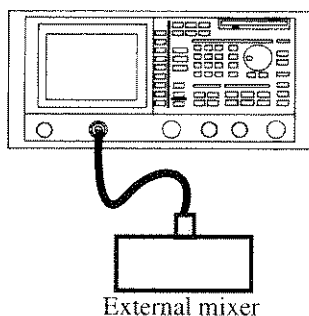

Figure 2-47 Setup for the R3182 and Waveguide Mixer

Power on

3. Turn the instrument power on.

Initializing the set conditions

This resets the current settings to the factory defaults.

4. Press **SHIFT** and **CONFIG(PRESET)**.
The factory defaults are loaded.

Switching to External Mixer Mode

5. Press **FREQ, 1/2_more** and **Mixer INT/EXT(EXT)**.

2.2.15 External Mixer (OPT16 thru OPT19)

Loading frequency correction data

This operation loads frequency correction data and setting conditions from a floppy disk compatible with the external mixer being used.

6. Press **RECALL** and *Device RAM/FD*(FD).
7. Select a file to be opened from the file list using the data knob. The relationships between the frequency ranges (of the external mixer being used) and the file names are shown below.

Table 2-3 File Names

OPT No.	Frequency range	External mixer used	File names
OPT16	26.5 to 40 GHz	WHMB-28S	WHMB28
OPT17	40 to 60 GHz	WHMB-19S	WHMB19
OPT18	50 to 75 GHz	WHMB-15S	WHMB15-1
	70 to 80 GHz		WHMB15-2
OPT19	75 to 110 GHz	WHMB-10S	WHMB10

8. Press *Recall*.
Frequency correction data is automatically loaded and External Mixer Mode is automatically set.

2.3 Measurement Examples

2.3.1 Measuring the Channel Power

The spectrum analyzer has a power measurement function which can be used to conveniently measure various types of power. This section describes how to measure the power of a specified channel bandwidth using the example below.

Measurement conditions:

This example shows how to measure channel power for a unit similar to PHS outputting a frequency of 1917.950 MHz and a level of 20 dBm.

Use appropriate parameter values to make the measurements shown below.

Setup

1. Connect the transmitter as shown in Figure 2-48.

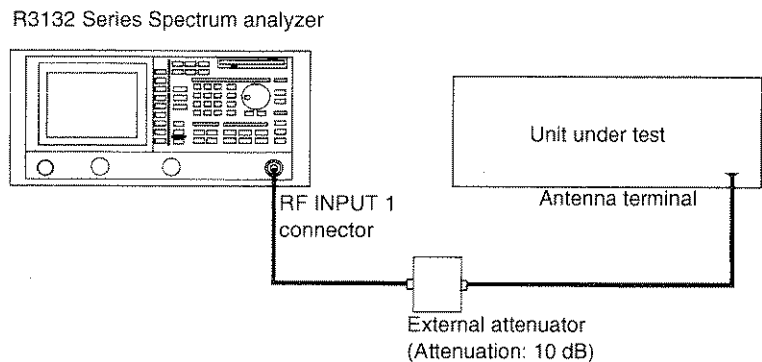

Figure 2-48 Setup for Measuring the Channel Power

Power on

2. Turn the power on.

Setting the unit under test

3. Turn on the signal output for the unit under test.

Initialization

This resets the current settings to the factory defaults.

4. Press **SHIFT** and **CONFIG(PRESET)**.
The default settings have now been reset.

2.3.1 Measuring the Channel Power

Setting the measurement conditions

This changes the analyzer settings so that the input signal is displayed more clearly.

5. Press **FREQ, 1, 9, 1, 7, ., 9, 5, 0** and **MHz**.
A center frequency of 1917.950 MHz is set.
6. Press **SPAN, 1** and **MHz**.
A frequency span of 1 MHz is set.
7. Press **BW, RBW AUTO/MNL(MNL), 1, 0** and **kHz**.
The RBW is set to 10 kHz.
8. Press **LEVEL, 1, 0** and **GHz(+dBm)**.
The reference level is set to 10 dBm.

Setting the offset level

9. Press **I/2_more, Ref Offset ON/OFF(ON), 1, 0** and **GHz(dB)**.
The offset level is set to 10 dB.
The measurement values, including values for the external attenuator, are now displayed.

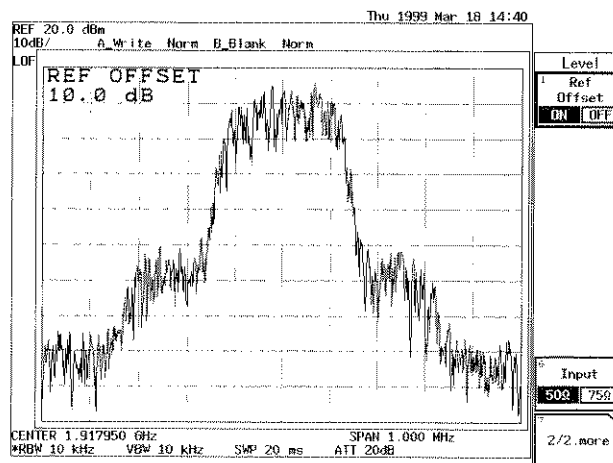

Figure 2-49 Setting the Offset Level

Measuring the power

10. Press **POWER MEASURE**.
The Power menu is displayed.
11. Press **Channel Power**.
The CH Power menu is displayed.
12. Press **Window Position, 1, 9, 1, 7, ., 9, 5, 0** and **MHz**.
The channel is set to 1917.950 MHz.

13. Press *Window Width, CH BW POS/WD, 3, 0, 0* and kHz.

The channel width is set to 300 kHz.

The Channel Power window is displayed, the channel power is measured and the measurement value is displayed in the Channel Power window. In addition, the display line showing the previously measured channel power is displayed.

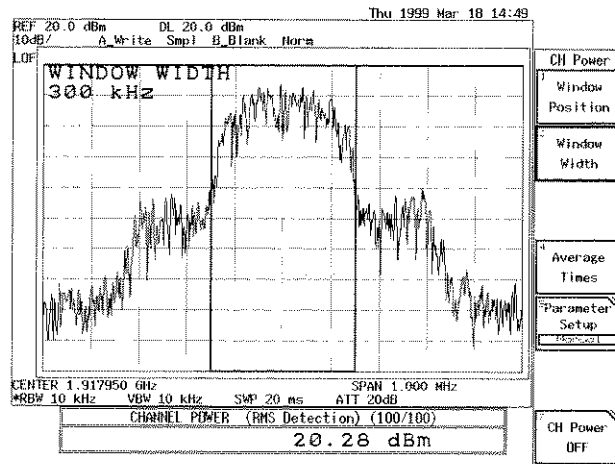

Figure 2-50 Measuring the Channel power

2.3.2 Measuring the Occupied Bandwidth (OBW)

2.3.2 Measuring the Occupied Bandwidth (OBW)

The occupied bandwidth can be calculated from the measured screen data using the OBW function. In this operation, the ratio of the OBW to the total power ranges from 10.0 to 99.8%. The initial setting is 99%.

Measurement conditions:

This example shows how to measure the occupied bandwidth for a unit similar to PHS outputting a frequency of 1917.950 MHz, an OBW of 288 kHz and a level of 20 dBm.

Use appropriate parameter values to make the measurements shown below.

NOTE: *NOTE: Set the reference level and the frequency span so that the signal amplitude on the screen is 50 dB or more in order to reduce operation error (when the signal amplitude on the screen does not exceed 50 dB, the operation error is large). The optimum span is approximately three times the occupied bandwidth.*

Setup

1. Connect the unit under test as shown in Figure 2-51.

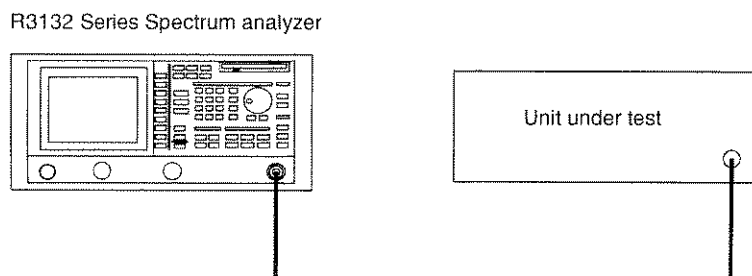

Figure 2-51 Setup for Measuring the Occupied Bandwidth

Power on

2. Turn the power on.

Setting the unit under test

3. Turn on the signal output for the unit under test.

Initialization

This resets the current settings to the factory defaults.

4. Press **SHIFT** and **CONFIG(PRESET)**.
The default settings have now been reset.

Setting the measurement conditions

This changes the analyzer settings so that the input signal is displayed more clearly.

5. Press **FREQ, 1, 8, 9, 5, ., 1, 5** and **MHz**.
A center frequency of 1895.15 MHz is set.
6. Press **SPAN, 8, 0, 0** and **kHz**.
A frequency span of 800 kHz is set.

Setting the detector mode

7. Press **TRACE, Detector** and **Posi**.
The trace is set to positive detector mode.

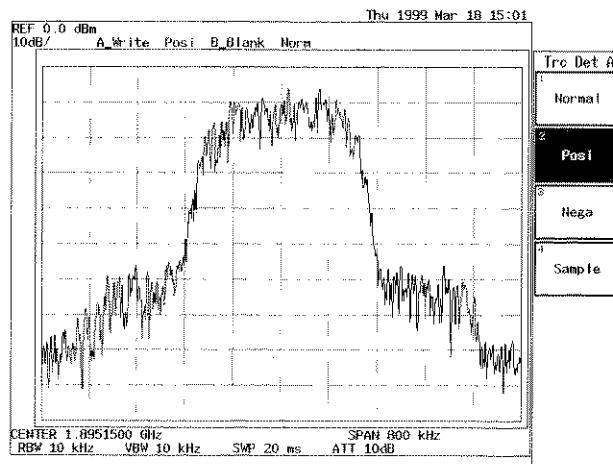

Figure 2-52 Setting the Detector Mode

Measuring the OBW

8. Press **POWER MEASURE** and **OBW**.
The OBW measurement is activated and the result displayed.

2.3.2 Measuring the Occupied Bandwidth (OBW)

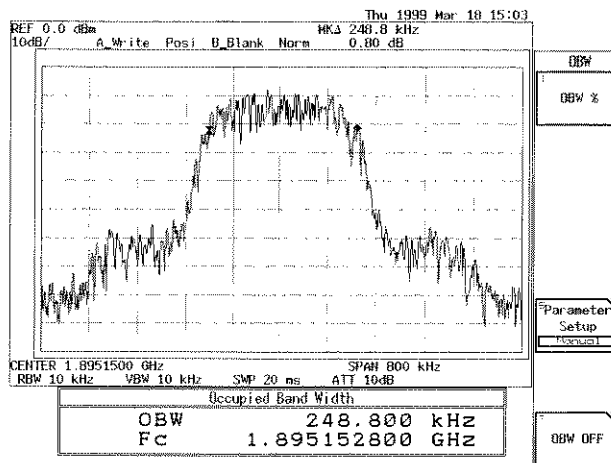

Figure 2-53 OBW Measurement Screen

When the measurement has been completed, a window showing the OBW and Fc of the occupied bandwidth is displayed (center refers to center frequency not carrier frequency), and two markers are placed at either end of the occupied bandwidth. In this example, which has a ratio of 99.0% (initial value), each marker is displayed at 0.5% and 99.5% of the total power.

Changing the ratio to the total power

This changes the ratio to 95%.

9. Press **OBW%**, **9**, **5** and **Hz(ENTER)**.
 The ratio to the total power is now 95%.

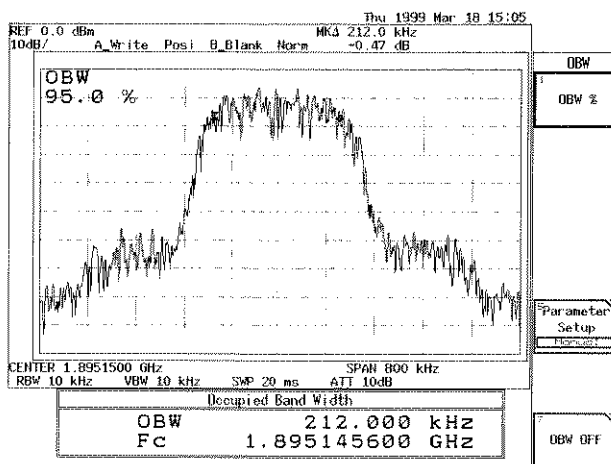

Figure 2-54 OBW(95%) Measurement Screen

2.3.3 Measuring Adjacent Channel Leakage Power (ACP)

One of the most important items to be measured of the digital modulating signal, which is used in the Personal Handy Phone and so on, is the adjacent channel leakage power (ACP).

In this section, the following two modes are explained: PDC digital modulating signal measurements in Full screen mode using the Root Nyquist filter, the adjacent (or the second adjacent) channel leakage power measurements for PHS in Separate screen mode.

Full screen mode: Calculates the total power using the data on the entire screen, calculates the channel leakage power of the upper and lower adjacent channels by integration to the specified bandwidth (BS), and calculates the ratio of the previously obtained values. The time required for taking measurements using this mode is shorter than the other mode since all necessary data is collected in a single sweep. In addition, a graphic function, which permits you to display the power at a point by integrating the leakage power over the specified bandwidth with respect to this point, is available.

Separate screen mode: Automatically sets the frequency span to the specified bandwidth, measures Carrier wave power (on the upper screen), measures the adjacent channel leakage powers (on the lower screens) (or the second adjacent leakage powers on the lower screens), and calculates the ratios separately. Using this mode, a higher accuracy is obtained when the channel spacing is large enough in relation to the specified bandwidth.

CAUTION:

1. *Set the values to meet the following unless otherwise specified.*

$$RBW \leq \frac{1}{40} \times \text{Specified bandwidth}$$

Detection mode: Sample

Trace Average function: OFF

2. *The VBW must meet the following.*

$$VBW \geq RBW$$

2.3.3.1 Full Screen Mode

This section describes how to measure PDC digital modulating signal using the Root Nyquist Filter in Full screen mode.

Measurement conditions: The unit used in this measurement must output a PDC signal with a frequency of 917.950 MHz and a level of 0 dBm.

Use appropriate parameter values to make the measurements shown below.

ACP Measurement Setup

1. Connect the unit under test as shown in Figure 2-55.

2.3.3 Measuring Adjacent Channel Leakage Power (ACP)

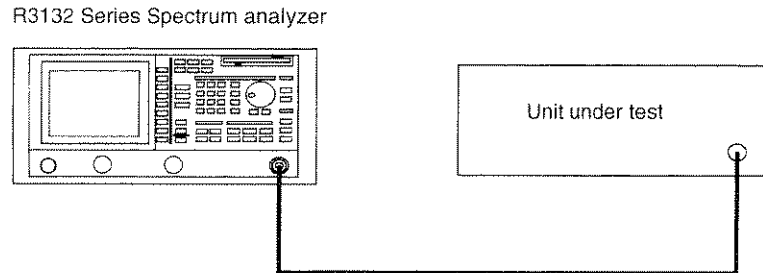

Figure 2-55 Setup Measuring Adjacent Channel Leakage Power

Power on

2. Turn the analyzer and the unit under test power on.

Setting the unit under test

3. Activate the signal output for the unit under test.

Initialization

This resets the current settings to the factory defaults or user-defined presets.

4. Press **SHIFT** and **CONFIG(PRESET)**.
This sets the analyzer to its presets values.

Setting the measuring conditions

This changes the analyzer settings so that the input signal is displayed more clearly.

5. Press **SPAN, 2, 5, 0** and **kHz**.
A frequency span of 250 kHz is set.

CAUTION: The frequency span must meet the conditions shown below.

$$\text{SPAN} \geq 2 \times \text{Channel spacing} + X$$

When specifying a Root Nyquist Filter:

$$X = (1 + \text{Rolloff factor}) \times \text{Symbol rate}$$

When not specifying a Root Nyquist Filter:

$$X = \text{Specified bandwidth}$$

6. Press **FREQ, 9, 1, 7, ., 9, 5, 0** and **MHz**.
A center frequency of 917.950 MHz is set.
7. Press **BW, RBW AUTO/MNL(MNL), 1** and **kHz**.
The RBW is set to 1 kHz.
8. Press **VBW AUTO/MNL(MNL), 3** and **kHz**.
The VBW is set to 3 kHz.

2.3.3 Measuring Adjacent Channel Leakage Power (ACP)

9. Press **TRACE**, *Detector* and *Posi*.
This sets the trace detector to the Positive mode.
10. Press **LEVEL** and adjust the trace using the data knob so that the trace peak can be within 1 graduation in relation to the reference level.

NOTE: *Measurement errors increase when the signal level is much lower than the reference level.*

11. Press **SWEEP**, *SWP Time AUTO/MNL(MNL)*, **2, 1** and **MHz(sec)**.
A sweep time of 21 seconds is set.

NOTE: *The sweep time must meet the following.*
Sweep time \geq Number of trace points \times Period of the burst signal

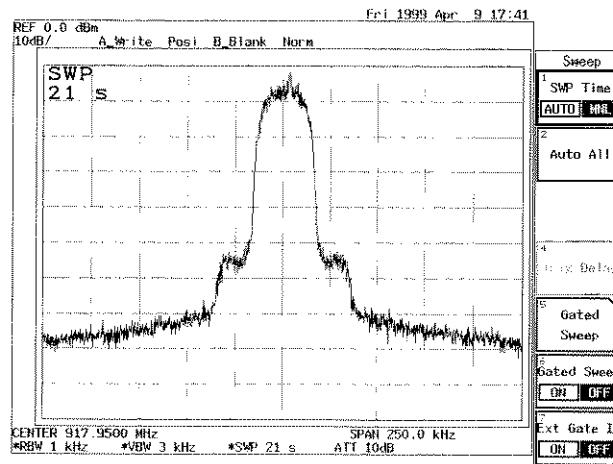

Figure 2-56 PDC trace

Channel spacing and specified bandwidth

Channel spacing and channel bandwidth are specified in PDC mode.

12. Press **POWER MEASURE**, *ACP* and *CS/BS Setup*.
The dialog box for setting the channel spacing and specified bandwidth is displayed. The cursor is moved to the 1st channel's Channel Space.
13. Press **5, 0** and **kHz**.
The channel spacing for channel 1 is set to 50 kHz. The cursor is moved to the 1st channel's Band Width.

2.3.3 Measuring Adjacent Channel Leakage Power (ACP)

14. Press **2, 1** and **kHz**.
The specified bandwidth for channel 1 is set to 21 kHz. The cursor is moved to the 2nd channel's Channel Space.
15. Press **1, 0, 0** and **kHz**.
The channel spacing for the channel 2 is set to 100 kHz. The cursor is moved to the 2nd channel's Band Width.
16. Press **2, 1** and **kHz**.
The specified bandwidth for channel 2 is set to 21 kHz.

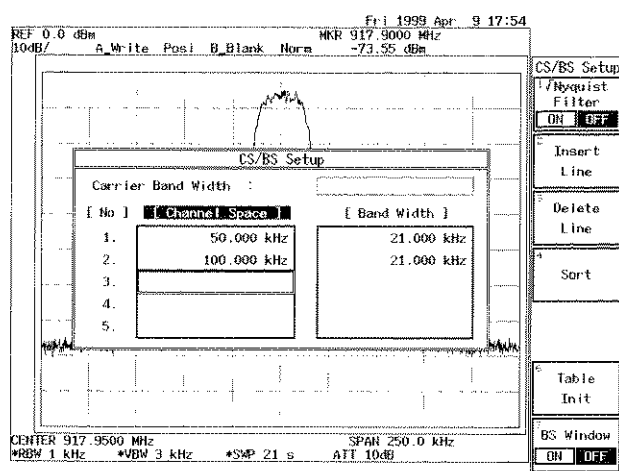

Figure 2-57 CS/BS Setup dialog box

17. Press **RETURN**.
This closes the CS/BS Setup dialog box.

NOTE: An ACP measurement cannot be carried out if the frequency span for the specified bandwidth and channel spacing is inappropriately set or not set.

Setting the Root Nyquist filter's correction function

18. Press $\sqrt{\text{Nyquist Filter Setup}}$.
The dialog box used to set Root Nyquist Filter parameters is displayed.
19. Move the cursor to *Symbol Rate 1/T* using the step keys and press **2, 1** and **kHz**.
A symbol rate of 21 kHz is set, and the cursor is moved to Rolloff Factor.
20. Press **0, ., 5** and **Hz(ENTR)**.
A rolloff factor of 0.5 is set.
21. Set $\sqrt{\text{Nyquist Filter ON/OFF}}$ (ON).
Allows you to set parameters and displays the data enter.

2.3.3 Measuring Adjacent Channel Leakage Power (ACP)

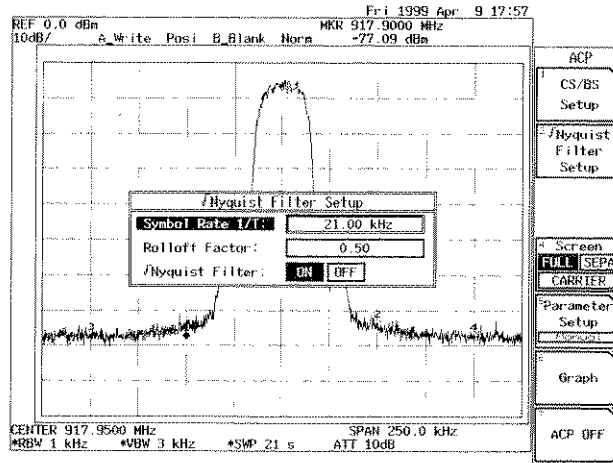

Figure 2-58 Root Nyquist Filter dialog box

22. Press $\sqrt{\text{Nyquist Filter Setup}}$.
The Root Nyquist Filter dialog box is closed.

Performing ACP

23. One marker is displayed in each of the upper and lower adjacent channels each time a sweep is performed, and the lower adjacent channel leakage power as well as the upper adjacent channel leakage power is displayed. When you press **SINGLE**, only one measurement is taken.

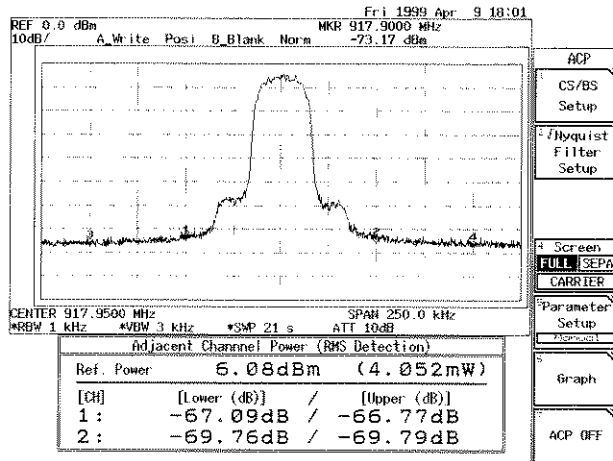

Figure 2-59 ACP Measurement Display in Full Screen Mode

2.3.3 Measuring Adjacent Channel Leakage Power (ACP)

Making observations using ACP GRAPH

24. Press **Graph**.

The calculation result of the adjacent channel leakage power and the delta marker are displayed.

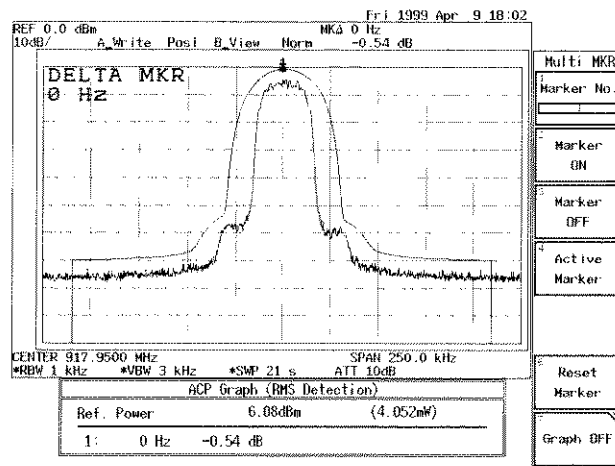

Figure 2-60 Measurement Using ACP GRAPH

Specifying measurement points

Moving the marker to another channel.

25. Move the marker to 100 kHz using the data knob.

The adjacent channel leakage power at 100 kHz is displayed in the result area.

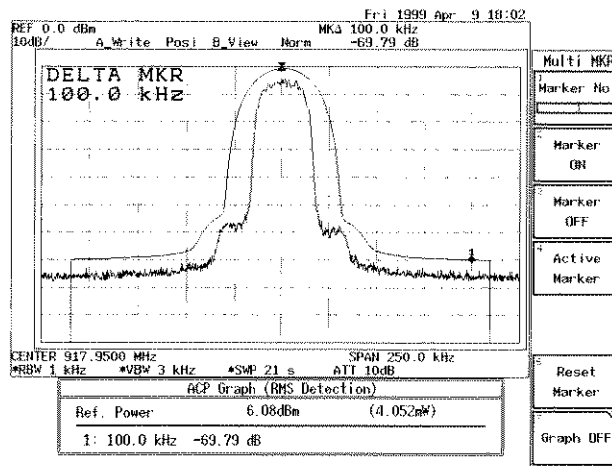

Figure 2-61 ACP at the 100 kHz

2.3.3.2 SEPARATE Display

This section describes how to measure PHS digital modulating signal in Separate screen mode.

Measurement conditions: The unit used in this measurement must output a PHS signal with a frequency of 1917.950 MHz and a level of +10 dBm.

Use appropriate parameter values to make the measurements shown below.

ACP Measurement Setup

1. Connect the unit under test as shown in Figure 2-62.

R3132 Series Spectrum analyzer

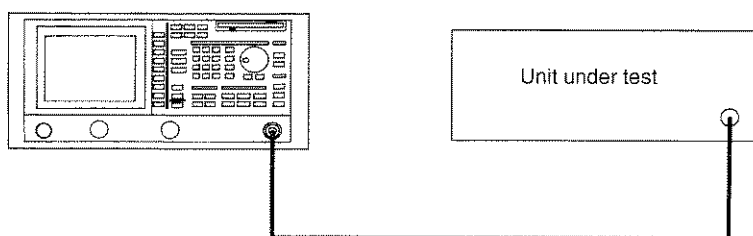

Figure 2-62 Setup Measuring Adjacent Channel Leakage Power

Power on

2. Turn the analyzer and the unit under test power on.

Setting the unit under test

3. Activate the signal output for the unit under test.

Initialization

This resets the current settings to the factory defaults or user-defined presets.

4. Press **SHIFT** and **CONFIG(PRESET)**.
This sets the analyzer to its presets values.

Setting the measuring conditions

This changes the analyzer settings so that the input signal is displayed more clearly.

5. Press **FREQ, 1, 9, 1, 7, ., 9, 5, 0** and **MHz**.
A center frequency of 1917.950 MHz is set.
6. Press **SPAN, 3** and **MHz**.
A frequency span of 3 MHz is set.
7. Press **LEVEL, ATT AUTO/MNL(MNL), 3, 0** and **GHz(dB)**.
The attenuator is set to 30 dB.
8. Press **LEVEL, 0** and **GHz(+dBm)**.
The reference level of 0 dBm is set.

2.3.3 Measuring Adjacent Channel Leakage Power (ACP)

9. Press **BW**, **RBW AUTO/MNL**(MNL), **3** and **kHz**.
The RBW is set to 3 kHz.
10. Press **VBW AUTO/MNL**(MNL), **1, 0** and **kHz**.
The VBW is set to 10 kHz.
11. Press **TRACE**, **Detector** and **Posi**.
This sets the trace detector to the Positive mode.
12. Press **LEVEL** and adjust the trace using the data knob so that the trace peak can be within 1 graduation in relation to the reference level.

NOTE: *Measurement errors increase when the signal level is much lower than the reference level.*

13. Press **SWEEP**, **SWP Time AUTO/MNL**(MNL), **5** and **MHz(sec)**.
A sweep time of 5 seconds is set.

NOTE: *The sweep time must meet the following.
Sweep time \geq Number of trace points \times Period of the burst signal*

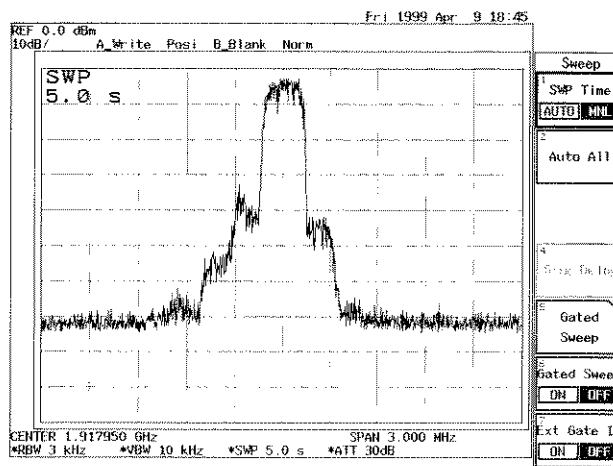

Figure 2-63 PHS Trace

Setting the Channel spacing and Specified Bandwidth

Channel spacing and channel bandwidth are specified in PHS.

14. Press **POWER MEASURE**, **ACP**, **Screen FULL/SEPA/CARRIER**(SEPA).
The screen mode is set to the separate.

2.3.3 Measuring Adjacent Channel Leakage Power (ACP)

15. Press **CS/BS Setup**.
The dialog box for setting the channel spacing and specified bandwidth is displayed.
16. Press **1, 9, 2** and **kHz**.
Carrier Band Width is now set to 192 kHz. The cursor is moved to the 1st channel's Channel Space.
17. Press **6, 0, 0** and **kHz**.
The channel spacing for channel 1 is set to 600 kHz. The cursor is moved to the 1st channel's Band Width.
18. Press **1, 9, 2** and **kHz**.
The specified bandwidth for channel 1 is set to 192 kHz. The cursor is moved to the 2nd channel's Channel Space.
19. Press **9, 0, 0** and **kHz**.
The channel spacing for the channel 2 is set to 900 kHz. The cursor is moved to the 2nd channel's Band Width.
20. Press **1, 9, 2** and **kHz**.
The specified bandwidth for channel 2 is set to 192 kHz.

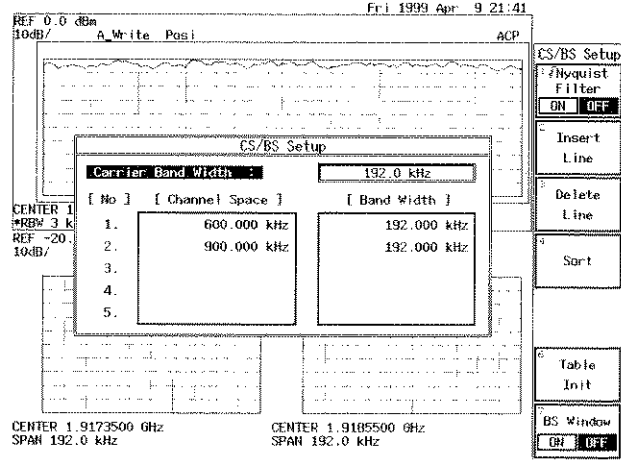

Figure 2-64 CS/BS Setup dialog box

21. Press **RETURN**.
This closes the CS/BS Setup dialog box.

NOTE: This operation will not function correctly when the specified bandwidth is inappropriate or not set.

2.3.3 Measuring Adjacent Channel Leakage Power (ACP)

Performing ACP using Separate screen

22. Each time a sweep is performed, the trace of a carrier signal is displayed on the upper screen, and the upper and lower adjacent channel traces are displayed on each of the two lower screens. The ACP values for both adjacent channels are displayed once every 5 sweeps.

When you press **SINGLE**, only five measurements are taken.

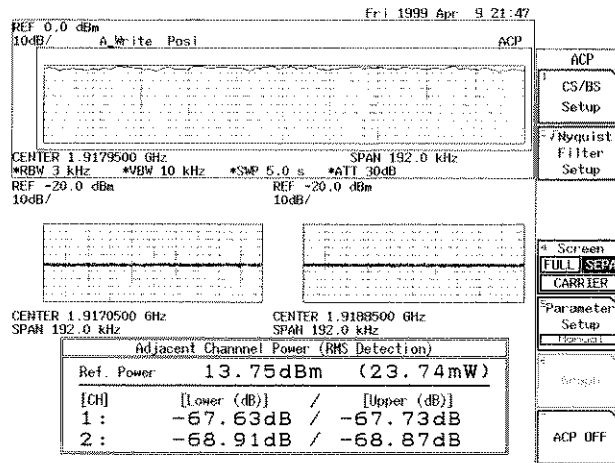

Figure 2-65 Measurement Result in ACP Separate Screen Mode

2.3.4 Measuring Burst Signals Using the Gated Sweep

This section describes how pulse modulation signals are measured using the gated sweep function.

Measurement conditions: The signal used in this measurement has an output frequency of 1 GHz, a level of 0 dBm, a pulse width of 1 msec and a period of 10 msec.

Use appropriate parameter values to make the measurements shown below.
(Opt29 is required.)

Setup

1. Connect the unit as shown in Figure 2-66.

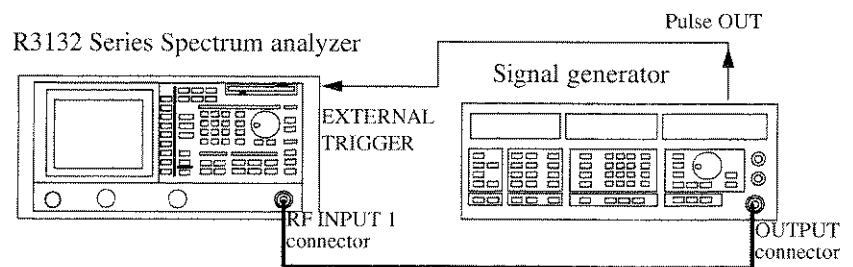

Figure 2-66 Setup for Measuring a Burst Signal

Power on

2. Turn the analyzer and the signal generator power on.

Setting the signal generator

This prepares the signal generator for output.

3. Set the frequency to 1 GHz; the level to 0 dBm; the pulse width to 1 msec; the period to 10 msec; and output to ON.

Initialization

This resets the current settings to the factory defaults or user-defined presets.

4. Press **SHIFT** and **CONFIG(PRESET)**.
This sets the analyzer to its presets values.

Setting the measurement conditions

This changes the analyzer settings so that the input signal is displayed more clearly.

5. Press **FREQ, 1** and **GHz**.
A center frequency of 1 GHz is set.
6. Press **SPAN, 5, 0, 0** and **kHz**.
A frequency span of 500 kHz is set.

2.3.4 Measuring Burst Signals Using the Gated Sweep

7. Press **LEVEL, 5** and **GHz(+dBm)**.
The reference level is set to +5 dBm.
8. Press **BW, RBW AUTO/MNL(MNL), 3** and **kHz**.
An RBW of 3 kHz is set.
9. Press **SWEEP, SWP Time AUTO/MNL(MNL), 2, 0, 0** and **kHz(ms)**.
Sweep time is set to 200 ms.

Setting the gated sweep

This sets the conditions of the gated sweep to bring the gated sweep into sync with the input signal.

10. Press **SWEEP** and **Gated Sweep**.
The Gated Sweep menu is displayed, and the gated sweep mode is set.
The upper screen displays the spectrum and the lower screen displays the waveform in the time domain in Split screen mode.

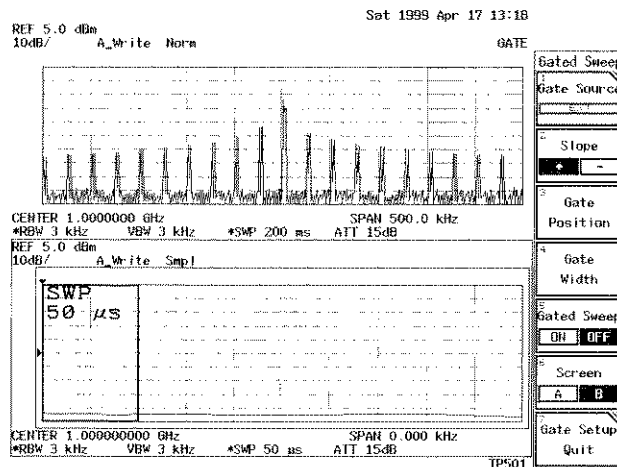

Figure 2-67 Burst Signal Displayed in Split Screen Mode

11. Press **2** and **kHz(ms)**.
A sweep time of 2 msec for the lower screen is set.

2.3.4 Measuring Burst Signals Using the Gated Sweep

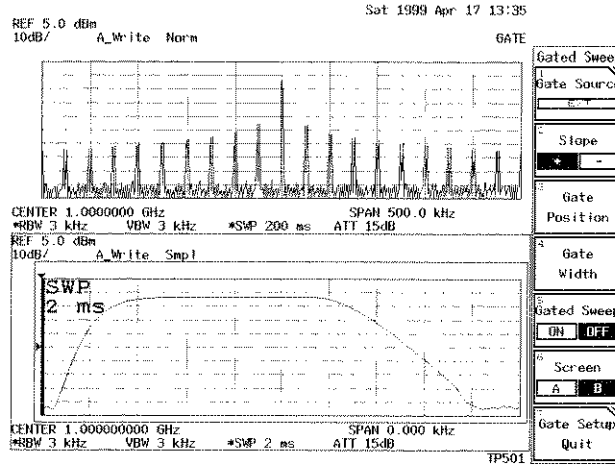

Figure 2-68 Trigger Setup

12. Press *Gate Position, 0, ., 6* and *kHz(ms)*.
The gate start position is set to 0.6 msec.
13. Press *Gate Width, 0, ., 3* and *kHz(ms)*.
A gate width of 0.3 msec is set.

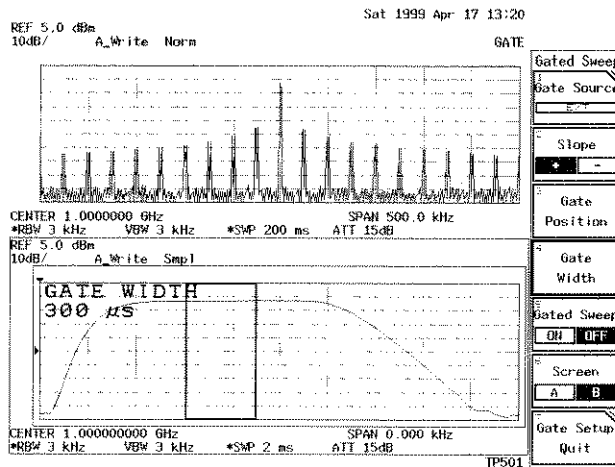

Figure 2-69 Gate Setup

14. Press *Gate Sweep ON/OFF(ON)*.
A spectrum without the effect caused by a burst signal will be displayed on the upper part of the screen.

2.3.4 Measuring Burst Signals Using the Gated Sweep

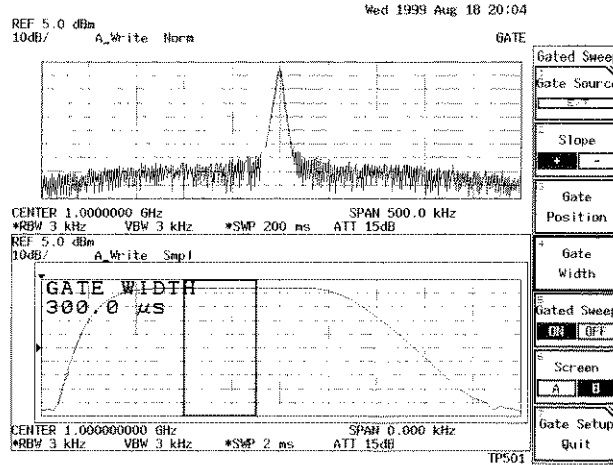

Figure 2-70 Burst Signal by Use of the Gated Sweep (Separate Screen Mode)

15. Press **Gate Setup Quit**.

The display shows the gated sweep trace in Full screen mode. You can now change the frequency span and reference level if desired.

NOTE: Check the gated sweep for its settings after you have changed the resolution bandwidth and video bandwidth of the spectrum (displayed on the upper screen) when measuring a burst signal using the gated sweep.

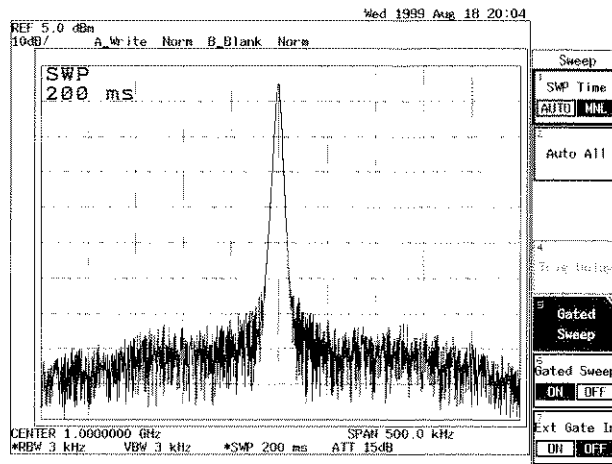

Figure 2-71 Burst Signal by Use of the Gated Sweep (Full Screen Mode)

2.3.5 Measuring Burst Signals in the Time Domain

This section describes how to measure the leading and trailing edges of the TDMA signal used in PHS and so on, using the time domain function.

Measurement conditions: The signal used in this measurement has an output frequency of 1917.950 MHz, a level of 0 dBm, a pulse width of 600 μ sec, a pulse period of 5 msec, a leading time of 13 μ sec, a trailing time of 13 μ sec of the burst signal. Use appropriate parameter values to make the measurements shown below. (Opt29 is required.)

Setup

1. Connect the unit as shown in Figure 2-72.

R3132 Series Spectrum analyzer

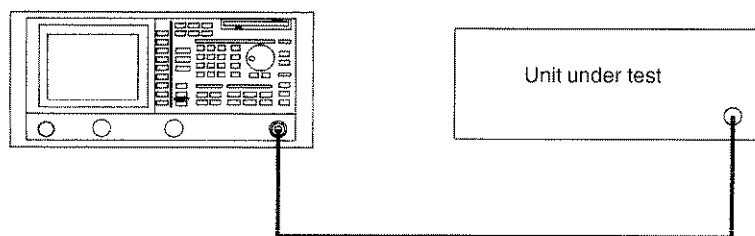

Figure 2-72 Setup for Measuring a Burst wave signal

Power on

2. Turn the analyzer and the unit under test power on.

Setting the unit under test

3. This prepares the unit under test for signal output.

Initialization

This resets the current settings to the factory defaults or user-defined presets.

4. Press **SHIFT** and **CONFIG(PRESET)**.
This sets the analyzer to its presets values.

Setting the measurement conditions

This changes the analyzer settings so that the input signal is displayed more clearly.

5. Press **FREQ, 1, 9, 1, 7, ,, 9, 5** and **MHz**.
A center frequency of 1917.95 MHz is set.
6. Press **SPAN, 0** and **MHz**.
The frequency span is set to zero span.

2.3.5 Measuring Burst Signals in the Time Domain

7. Press **LEVEL**, **5** and **GHz(+dBm)**.
The reference level is set to +5 dBm.

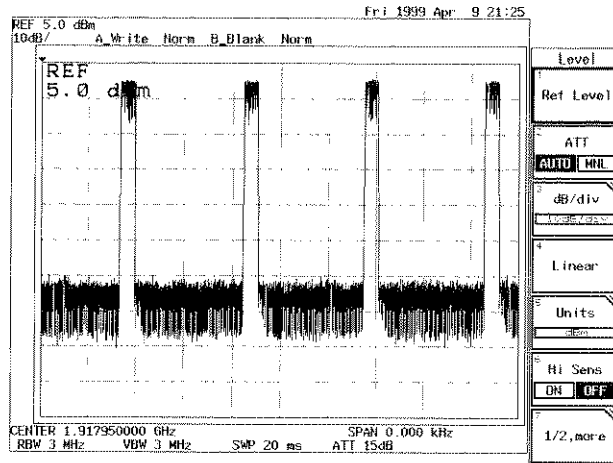

Figure 2-73 Burst Signal in the Time Domain

8. Press **SWEEP**, **SWP Time AUTO/MNL(MNL)**, **5** and **kHz(ms)**.
A sweep time of 5 msec is set.

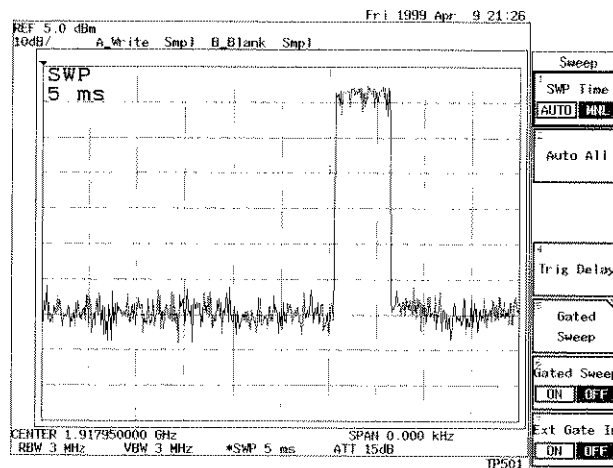

Figure 2-74 Burst Signal in the Time Domain

Setting the video trigger

9. Press **TRIG**, **Trig Source** and **Video Trig**.
Video is selected.
The trigger level mark (→) is displayed on the left edge vertical axis.

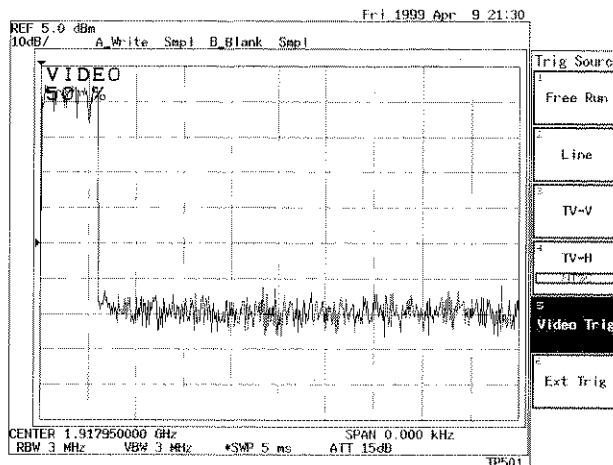

Figure 2-75 Burst Signal in Synchronization with the Trigger Signal

10. Adjusts the trigger level to 70% using the knob.

Setting the leading edge of a waveform

11. Press **SWEEP, 5, 0** and **Hz(μs)**.
A Sweep time of 50 μsec is set.
12. Press **Trig Delay, -, 2, 5** and **Hz(μs)**.
The waveform is displayed 25 μsec before the triggering point so you can observe the leading edge of the burst signal.

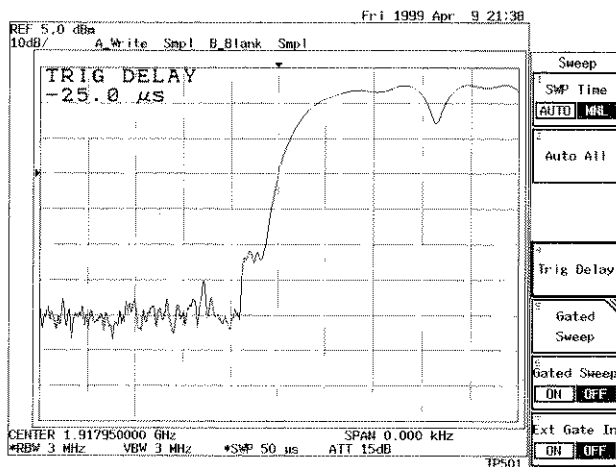

Figure 2-76 Measuring Burst Signal Leading Edge

2.3.5 Measuring Burst Signals in the Time Domain

Setting the trailing edge of a waveform

13. Press *Trig Delay*, **5**, **7**, **5** and **Hz(μs)**.

The waveform is displayed 575 μsec after the triggering point so you can observe the trailing edge of the burst signal.

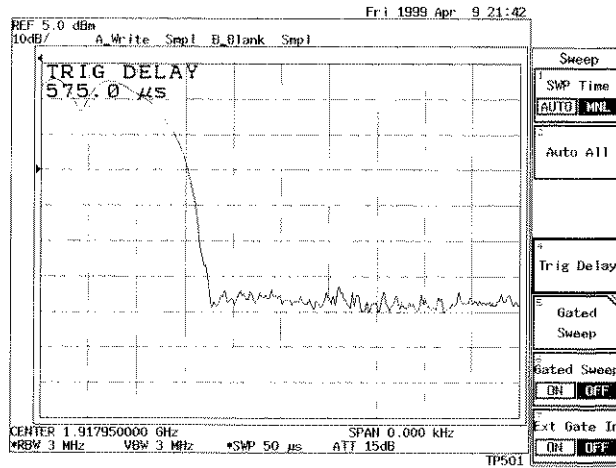

Figure 2-77 Measuring Burst Signal Trailing Edge

2.3.6 Pass/Fail Judgments Using the Limit line Function

Pass/fail judgments for traces on the screen can easily be made by storing the upper (Line 1) and lower (Line 2) limit values using the limit line function.

Power on

1. Turn the power on.

Connecting the input signal cable

2. Connect the calibration signal used in the measurement.

Initialization

This resets the current settings to the factory defaults or user-defined presets.

3. Press **SHIFT** and **CONFIG(PRESET)**.
This sets the analyzer to its presets values.

Setting the measurement conditions

This changes the analyzer settings so that the input signal is displayed more clearly.

4. Press **FREQ, 3, 0** and **MHz**.
The center frequency is set to 30 MHz.
5. Press **SPAN, 2, 0** and **MHz**.
A frequency span of 20 MHz is set.
6. Press **LEVEL, 0** and **GHz(+dBm)**.
The reference level is set to 0 dBm.

2.3.6 Pass/Fail Judgments Using the Limit Line Function

Setting the limit line

Each limit line uses the data in the table.

Table 2-4 Setting Limit Line 1

	Frequency	Level
1	22 MHz	-70 dBm
2	27 MHz	-70 dBm
3	28.5 MHz	-5 dBm
4	31.5 MHz	-5 dBm
5	33 MHz	-70 dBm
6	38 MHz	-70 dBm

Table 2-5 Setting Limit Line 2

	Frequency	Level
1	22 MHz	-95 dBm
2	29 MHz	-95 dBm
3	29.5 MHz	-60 dBm
4	30.5 MHz	-60 dBm
5	31 MHz	-95 dBm
6	38 MHz	-95 dBm

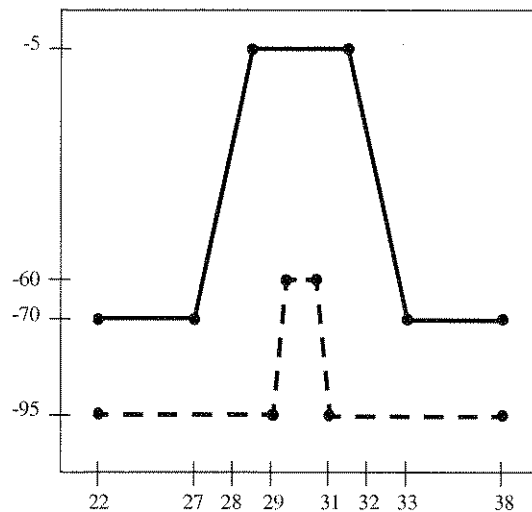

7. Press **PAS/FAIL**, and *Limit Line Edit*.
The Edit menu and editor used for Limit Line 1 are displayed.
8. Press **2, 2** and **MHz**.
22 MHz is set in the first frequency entry, and the cursor moves to the level entry.
9. Press **7, 0** and **MHz(-dBm)**.
-70 dBm is set in the first level entry, and the cursor moves to the second row.

10. Continue entering data into Table 2-4, repeating steps 8 and 9.

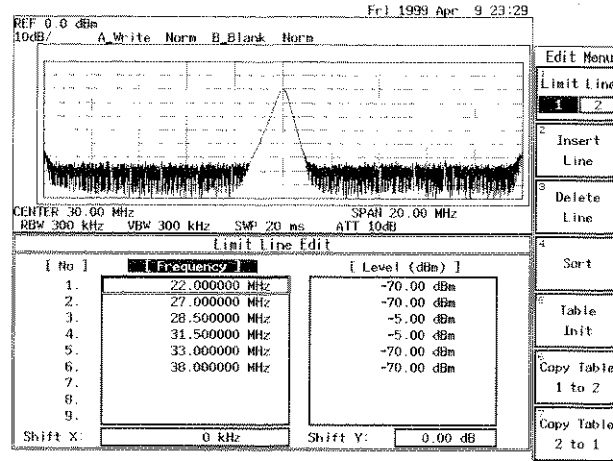

Figure 2-78 Screen Displayed after Limit Line 1 Data Has Been Entered

11. Press **Limit Line 1/2(2)**.
The editor is changed from the Limit line 1 mode to the Limit line 2 mode.
12. Press **2, 2** and **MHz**.
A frequency of 22 MHz is set in the frequency entry used for Limit Line 2. The cursor moves to the level entry.
13. Press **9, 5** and **MHz(-dBm)**.
A level of -95 dBm is set in the first level entry.
14. Continue entering data into Table 2-5, repeating steps 12 and 13.

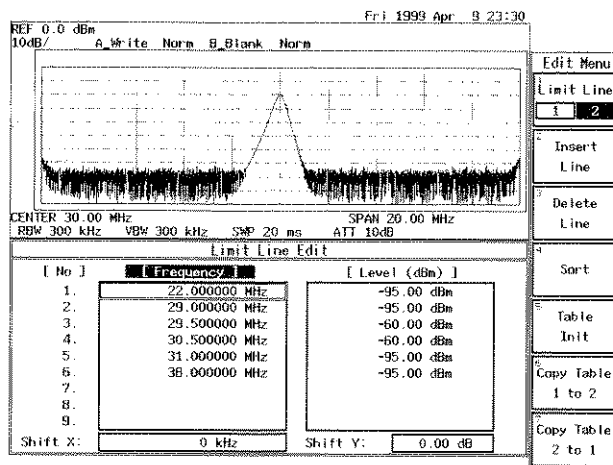

Figure 2-79 Screen Displayed after Limit Line 2 Data Has Been Entered

2.3.6 Pass/Fail Judgments Using the Limit line Function

15. Press **RETURN**.
The editor for Limit line 2 is closed and the Pass/Fail menu is displayed.

Displaying the Limit Line 1 and setting the Pass/Fail criteria

16. Press **Line1 ON/OFF(ON)**.
Limit Line 1 is displayed, and then the Pass/Fail result is displayed.

Limit Line 1 displays a higher limit for waveform data.
When waveform data values are lower than Limit Line 1, the result is Pass.

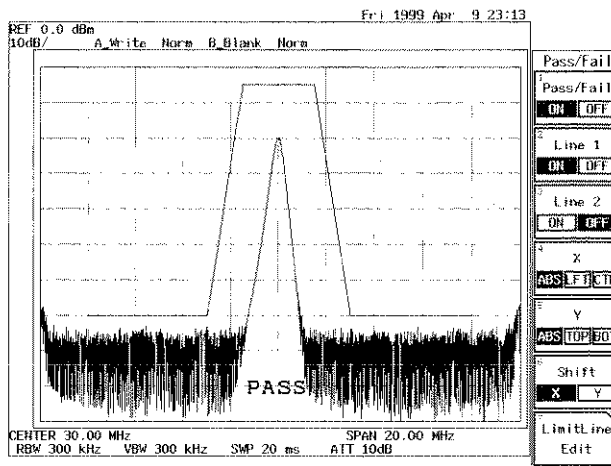

Figure 2-80 PASS/FAIL Result using Limit Line 1 (PASS)

Displaying the Limit Line 2 and setting the Pass/Fail criteria

17. Press **Line2 ON/OFF(ON)**.
Limit Line 2 is displayed, and then the Pass/Fail result is displayed.

Limit Line 2 displays a lower limit for waveform data.
When waveform data values are higher than Limit Line 2, the result is Pass.

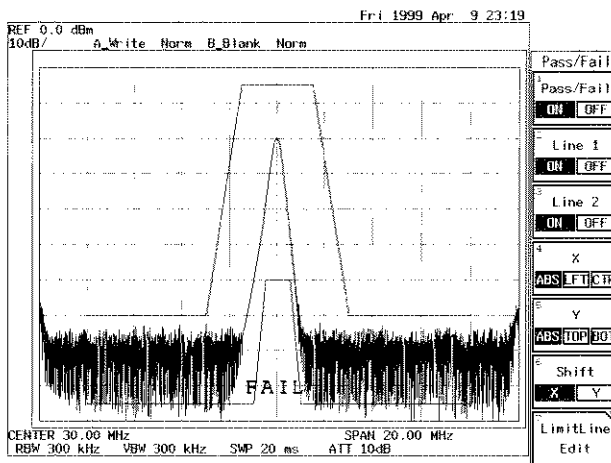

Figure 2-81 PASS/FAIL Result using Limit Lines 1 and 2 (FAIL)

18. Press **BW**, **VBW AUTO/MNL**(MNL), **3, 0** and **kHz**.
 The VBW is set to 30 kHz.
 Waveform data values become higher than Limit Line 2, the result becomes Pass accordingly.

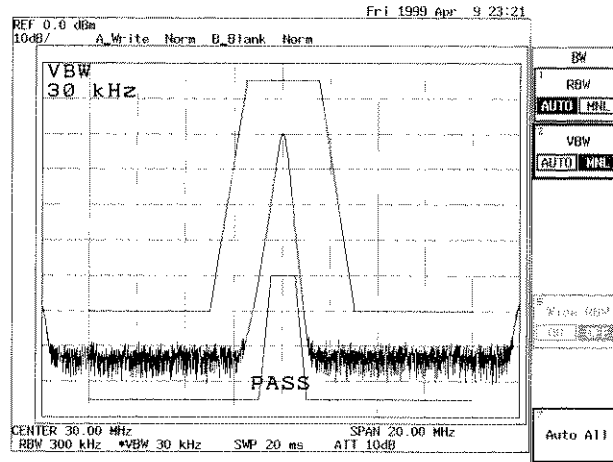

Figure 2-82 PASS/FAIL Result using Limit Lines 1 and 2 (PASS)

Setting an offset for the limit line

19. Press **PAS/FAIL**, and **Shift X/Y(X)**.
 Enter an arbitrary value used as the Limit Line frequency offset.

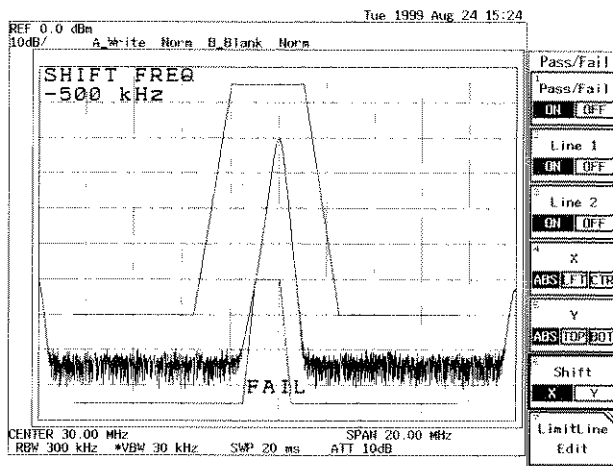

Figure 2-83 Judgment Result after the Offset Has Been Changed (FAIL)

20. Press **PAS/FAIL**, **Shift X/Y(Y)**.
 Enter an arbitrary value used as the Limit Line level offset.

2.3.6 Pass/Fail Judgments Using the Limit line Function

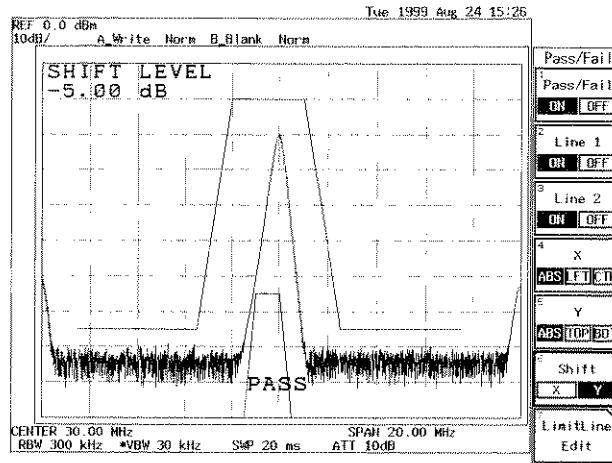

Figure 2-84 Judgment Result after the Offset Has Been Changed (PASS)

2.3.7 Measurements Using TG (OPT74)

Band-pass filter characteristics with a passband of approximately 270 MHz, are measured (both the insertion loss and bandwidth are measured).

CAUTION: *UNCAL messages, displayed when measuring frequency characteristics using this function, do not affect measurement results.*

Setup

1. Connect the unit under test as shown in Figure 2-85.

R3132 Series Spectrum analyzer

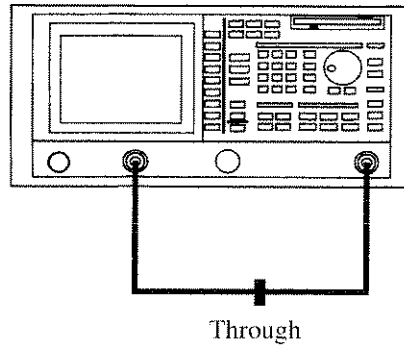

Figure 2-85 Setup for TG Measurements

Power on

2. Turn the power on.

Initialization

This resets the current settings to the factory defaults.

3. Press **SHIFT** and **CONFIG(PRESET)**.
The default settings have now been reset.

Setting the measurement conditions

This changes the analyzer settings so that the input signal is displayed more clearly.

4. Press **FREQ, 2, 7, 0** and **MHz**.
A center frequency of 270 MHz is set.
5. Press **SPAN, 1, 0, 0** and **MHz**.
A frequency span of 100 MHz is set.
6. Press **LEVEL, 0** and **GHz(+dBm)**.
The reference level is set to 0 dBm.

2.3.7 Measurements Using TG (OPT74)

7. Press **LEVEL**, *dB/div* and *2dB/div*.
The amplitude scale (vertical axis) graduation is set to 2dB/div.
8. Press **TG**, *TG Level, 5* and **MHz(-dBm)**.
The output level of the tracking generator is set to -5 dBm.
9. Press **TG** and *Execute Normalize*.
The normalization calibration is performed.

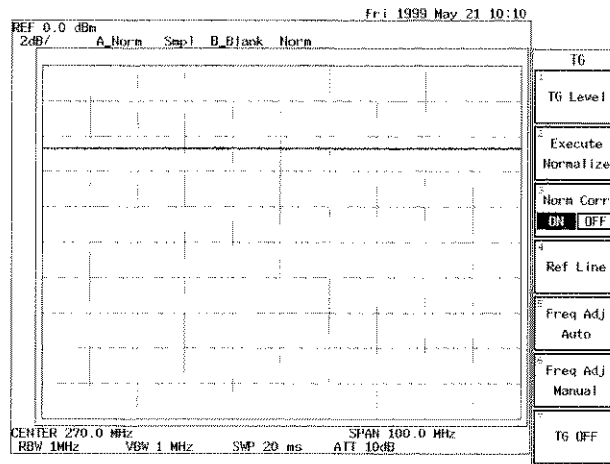

Figure 2-86 Measurement Screen after a Normalization Calibration

NOTE: When you change center frequency, frequency span, reference level, level indication scale and so on after executing a normalization calibration, subsequent normalization results will be incorrect.
Be sure to re-execute the normalization operation if you change any of these settings.

Connecting the unit under test

10. Connect the unit under test between TG OUTPUT and RF INPUT1 as shown in Figure 2-87.

R3132 Series Spectrum analyzer

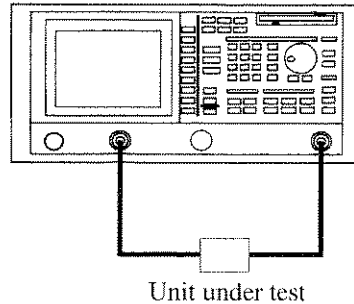

Figure 2-87 Connecting the Unit under Test

Setting the sweep time

Set a sweep time long enough to not affect the trace.
In this step, set it to 50 ms.

11. Press **SWEEP**, **SWP Time AUTO/MNL**, **5, 0** and **kHz(msec)**.

CAUTION: *If the input signal level changes abruptly, the IF filter in this instrument will not respond to this change. If this occurs, make the sweep slow enough or the span narrow enough until the characteristics and displayed trace are stabilized.*

Measuring the insertion loss

12. Press **PK SRCH**.
The current marker level is the insertion loss of the filter.

CAUTION: *When the loss of the unit under test is high, you can take measurement by use of an amplifier to keep the dynamic range at a moderate level.*

2.3.7 Measurements Using TG (OPT74)

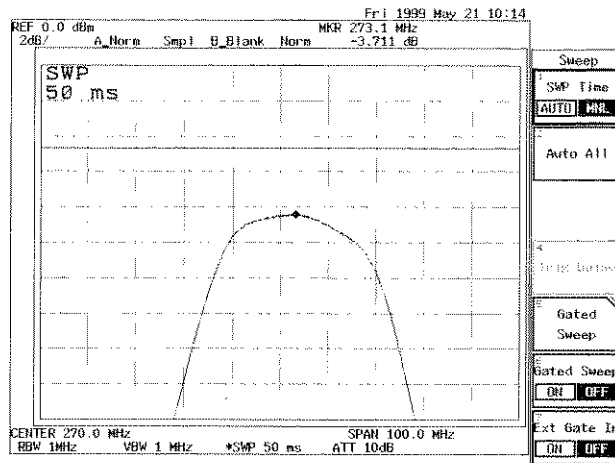

Figure 2-88 Insertion Loss Measurement Screen

Measuring a Bandwidth of 3 dB

This measurement is taken under the same conditions as the insertion loss..

13. Press **MEAS**, **XdB Down**, **3**, **GHz(+dBm)** and **XdB Down**.
Two markers are displayed on both sides 3 dB down from peak.
The filter bandwidth of 3 dB is displayed in the level field of the marker frequency

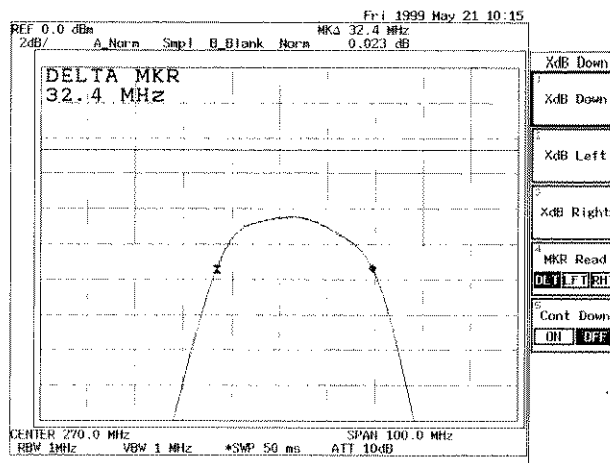

Figure 2-89 3-dB Bandwidth Measurement Screen

2.3.8 Spectrum Mask Measurement

The ACP is measured using the ratio of the adjacent leakage power to the total power on the full screen, while the spectrum mask is measured using the ratio of the adjacent channel power to the power within the BS (specified bandwidth) on the full screen. In addition, the near band spurious spectrum can be measured because the power relative to the power at the marker point can be measured by setting an adjacent channel's BS to 0 Hz. It is possible to make Pass/fail judgments for the near band spurious spectrum when the power is adjusted to the maximum power using a limit line.

In this section, the method used to measure modulating signals used for IS-95 (cdmaOne) is described.

Measurement conditions: The signal to be measured is a signal used for cdmaOne, and has a frequency of 825 MHz and a level of 0 dBm. Use appropriate parameter values to make the measurements shown below.

Setup

1. Connect the instrument as shown in Figure 2-90.

R3132 Series Spectrum analyzer

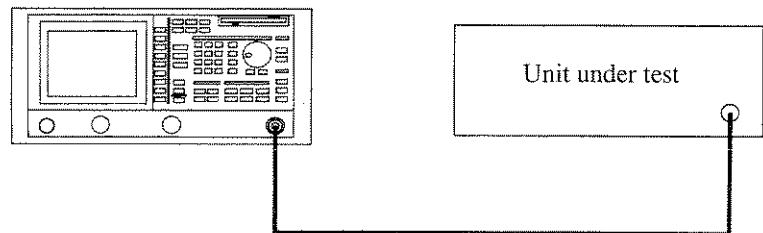

Figure 2-90 Setup for Measuring the Spectrum Mask

Power on

2. Turn the analyzer and the unit under test power on.

Setting the unit under test

3. Activate the signal output for the unit under test.

Initialization

This resets the current settings to the factory defaults or user-defined presets.

4. Press **SHIFT** and **CONFIG(PRESET)**.
This sets the analyzer to its presets values.

Setting the Limit Line

In this example, the template compatible with IS-95 is used to set the limit line. The frequencies are relative to the center frequency on the horizontal axis, and the levels are relative to the reference position located at the highest level on the vertical axis.

2.3.8 Spectrum Mask Measurement

Table 2-6 Setting Limit Line1

	Frequency	Level
1	-2.5MHz	-54dB
2	-1.98MHz	-54dB
3	-1.98MHz	-42dB
4	-900kHz	-42dB
5	-900kHz	0dB
6	900kHz	0dB
7	900kHz	-42dB
8	1.98MHz	-42dB
9	1.98MHz	-54dB
10	2.5MHz	-54dB

5. Press **PAS/FAIL** and *Limit Line Edit*.
The Edit menu is displayed.
Limit Line 1 is selected and the Limit Line 1 editor is displayed.
6. Press **-, 2, ., 5** and **MHz**.
A frequency of -2.5 MHz is set for the 1st frequency, and the cursor is moved to the first level box.
7. Press **5, 4** and **MHz(-dBm)**.
A level of -54 dB is set for the 1st level, and cursor is moved to the 2nd frequency box.
8. Repeat Steps 6. and 7. to enter the remaining data in Table 2-6.
9. Press **RETURN**.
The Limit Line 1 editor is removed and the Pass/Fail menu is displayed.
10. Press **X ABS/LFT/CTR(LFT)** and **X ABS/LFT/CTR(CTR)**.
The frequencies entered are set relative to the center frequency on the horizontal axis.
11. Press **Y ABS/TOP/BOT(TOP)**.
The levels, which are relative to the reference position located at the highest level on the vertical axis, are set.

Setting the measurement conditions

This changes the analyzer settings so that the input signal is displayed more clearly.

12. Press **FREQ, 8, 2, 5** and **MHz**.
A center frequency of 825 MHz is set.
13. Press **SPAN, 5** and **MHz**.
A frequency span of 5 MHz is set.
14. Press **BW, RBW AUTO/MNL(MNL), 3, 0** and **kHz**.
An RBW of 30 kHz is set.
15. Press **VBW AUTO/MNL(MNL), 1** and **MHz**.
A VBW of 1 MHz is set.
16. Press **TRACE, Detector** and **Posi** (or **Sample**).
The trace detector is set to the positive peak detector mode.

Posi : The Ref. Power of the measurement result is 6 dB higher than the channel power, but the measurement value of the adjacent channel leakage ratio is the same as the one obtained using Sample. This mode is used when the near band spurious spectrum is measured.

Sample : The Ref. Power of the measurement result is the same as the channel power. This mode is used when power measurements.

17. Press **LEVEL** and adjust the data knob so that the trace peak is positioned approximately 2 graduations below the reference level.
18. Press **SWEEP, SWP Time AUTO/MNL(MNL), 2, 0, 0** and **kHz(msec)**.
A sweep time of 200 ms is set.

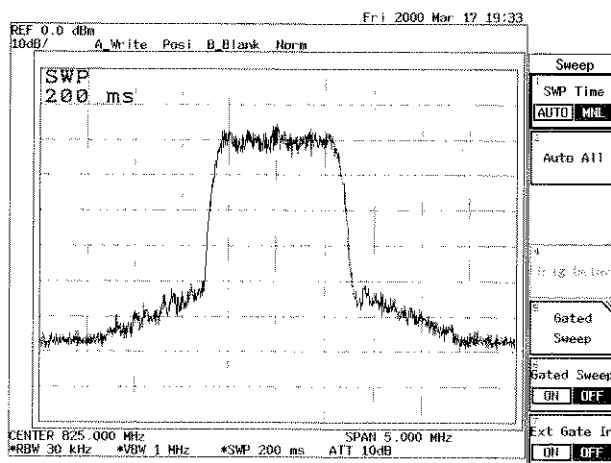

Figure 2-91 A Trace Used with IS-95

Setting the channel spacing and specified bandwidth

The channel spacing and specified bandwidth, which are compatible with IS-95, are set.

2.3.8 Spectrum Mask Measurement

19. Press **POWER MEASURE**, *1/2_more* and *Spectrum Mask*.
Limit Line 1 is displayed and the frequency span is optimized using the previously set channel spacing and specified bandwidth.
20. Press **SPAN**, **5** and **MHz**.
A frequency span of 5 MHz is set again.
21. Press **POWER MEASURE** and *CS/BS Setup*.
The dialog box used to set the channel spacing and specified bandwidth is displayed.
22. Press **1**, **,**, **2**, **3** and **MHz**.
A carrier bandwidth of 1.23 MHz is set. The cursor is moved to the 1st channel's Channel Space.
23. Press **9**, **0**, **0** and **kHz**.
The 1st channel's channel spacing is set to 900 kHz. The cursor is moved to the 1st channel's Band Width.
24. Press **0** and **Hz**.
The 1st channel's specified bandwidth is set to 0 Hz. The cursor is moved to the 2nd channel's Channel Space.
25. Press **1**, **,**, **9**, **8** and **MHz**.
The 2nd channel's channel spacing is set to 1.98 MHz. The cursor is moved to the 2nd channel's Band Width.
26. Press **0** and **Hz**.
The 2nd channel's specified bandwidth is set to 0 Hz.

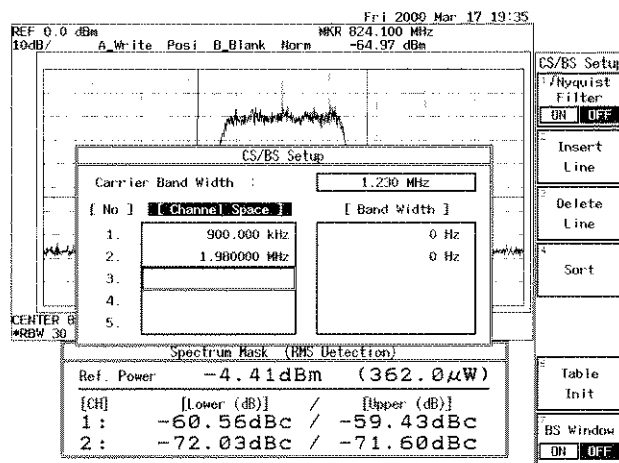

Figure 2-92 CS/BS Setup Dialog Box

27. Press **RETURN**.
The CS/BS Setup dialog box is closed.

Measurements Using the Spectrum Mask Function

28. Two markers are displayed at both of the adjacent channel positions for each sweep, and a ratio of the channel leakage power to the channel power within the carrier bandwidth is displayed for the corresponding adjacent channel.

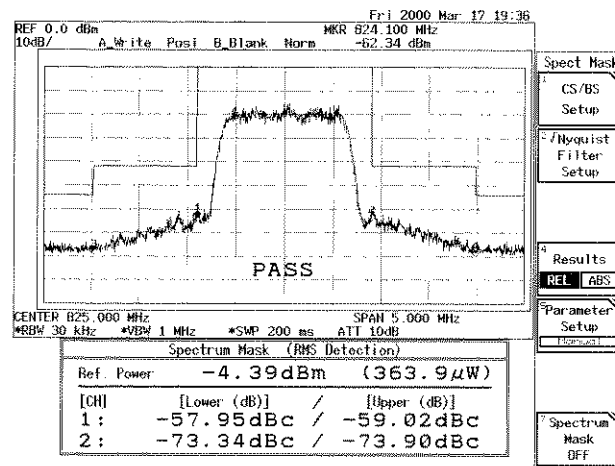

Figure 2-93 Spectrum Mask Measurement Screen

2.3.9 Measuring Output Levels Using the Software Image Suppression function (OPT16 thru OPT19)

Frequencies and output levels of a VCO unit are measured after unnecessary image signals have been eliminated using the Software Image Suppression function.

Measurement conditions: The measurement target is a VCO unit with a frequency of 92 GHz and an output level of -15 dBm. OPT19 (Frequency range: 75 to 110 GHz) is used as the external mixer.

Setup

1. Set up the instruments as shown in Figure 2-94.

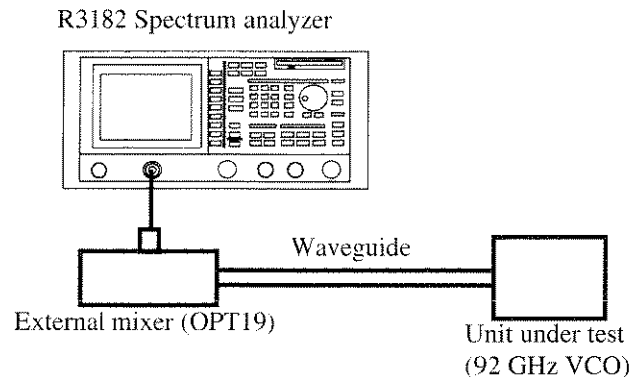

Figure 2-94 Setup for measuring VCO Output Levels

Power on

2. Turn the instrument power on.

Initializing the set conditions

This resets the current settings to the factory defaults.

3. Press **SHIFT** and **CONFIG(PRESET)**.
The factory defaults are loaded.

Setting the measurement conditions

Load the frequency correction data using the same procedure described in Section 2.2.15. "External Mixer (OPT16 thru OPT19)." After data has been loaded from the floppy disk, the mixer is automatically set to External Mixer Mode, and the settings corresponding to the external mixer being used are also set automatically.

In this example, the file name WHMB10 is loaded.

External Mixer Mode is turned on, and a frequency range of 75 to 110 GHz is displayed on the screen because a frequency band of 9 has been set.

2.3.9 Measuring Output Levels Using the Software Image Suppression function (OPT16 thru OPT19)

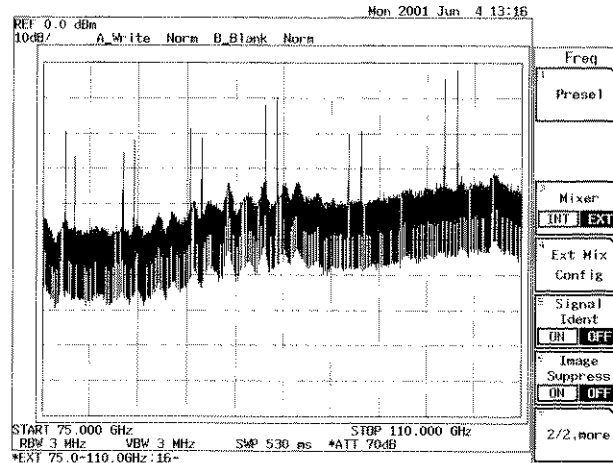

Figure 2-95 Measurement Signal with an Image Signal

4. Press **RETURN** and **Image Suppress ON/OFF(ON)**.
Image Suppression function is turned on, and the output signal from the unit under test is displayed after the image signal has been eliminated.

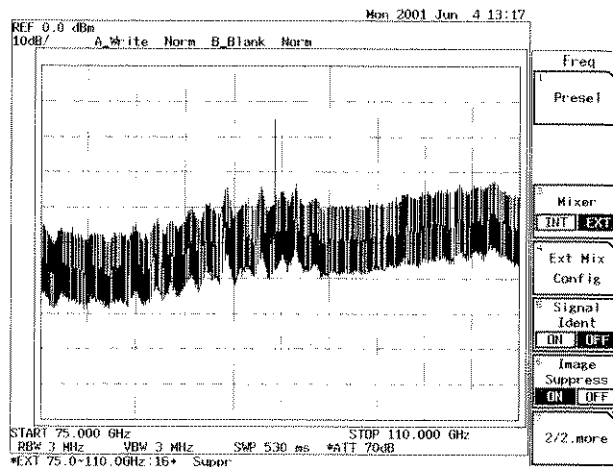

Figure 2-96 Measurement Signal with the Image Signal Eliminated

Examining signals using the ZOOM function

5. Press **DISPLAY**, **Multi Screen** and **Zoom**.
A waveform with the image signal eliminated is displayed on the A screen (upper), and a waveform without the image signal eliminated is displayed on the B screen (lower).
The Zoom window is displayed on the A screen, and the Zoom Position is ready to be entered.
6. Press **9, 2** and **GHz**.
The window position is set to 92 GHz.

2.3.9 Measuring Output Levels Using the Software Image Suppression function (OPT16 thru OPT19)

7. Press **Zoom Width, 3, ,, 5** and **GHz**.
The window width is set to 3.5 GHz.

8. Press **Screen A/B(B)** and **PK SRCH**.
The peak search function displays a marker on the peak of the output signal from the unit under test.
The level and frequency of the output signal is displayed in the marker area.

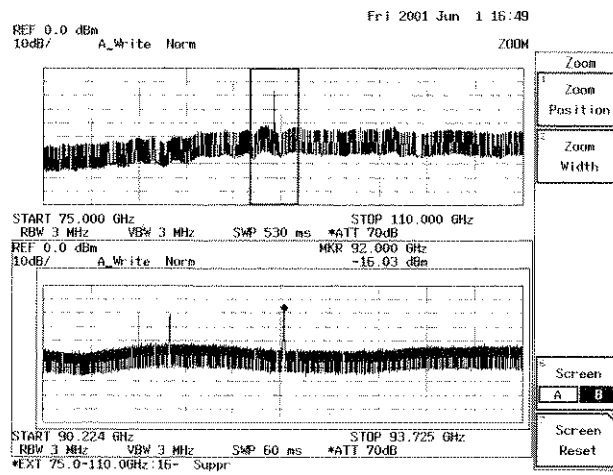

Figure 2-97 Software Image Suppression Function in Split Screen Mode

2.3.10 FM Demodulation Function (OPT73)

This section explains how to measure FM modulation signal characteristics (FM deviation, sensitivity and linearity measurements).

Measurement conditions: The signal to be measured is a triangle modulation signal (of an FM frequency of 10 Hz, and an FM deviation of 2.6 kHz) with a center frequency of 200.003 MHz, a level of 0 dBm.

Use appropriate parameter values to make the measurements shown below.

Setup

1. Connect the analyzer and the unit under test as shown in Figure 2-98.

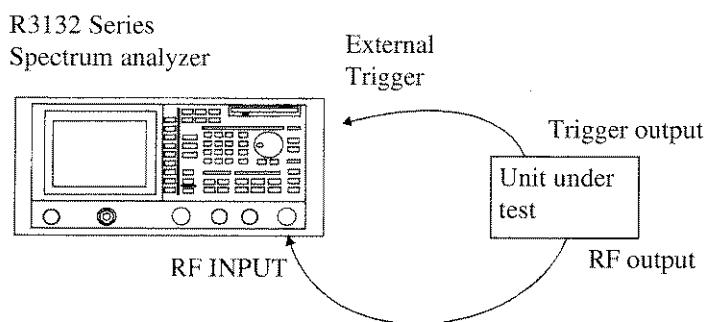

Figure 2-98 Setup for Measurements Using the FM Demodulation Function

Power on

2. Turn the analyzer power and the unit under test power on.

Initializing the set conditions

This resets the current settings to the factory defaults.

3. Press **SHIFT** and **CONFIG(PRESET)**.
The factory defaults are loaded.

Setting the measurement conditions

This changes the analyzer settings so that the input signal is displayed more clearly.

4. Press **FREQ, 2, 0, 0, ., 0, 0, 3** and **MHz**.
A center frequency of 200.003 MHz is set.
5. Press **UTILITY** and **FM Demod.**
The FM demodulation function is turned on.
6. Press **Demod Cal** and **All**.
The calibration prior to an FM demodulation measurement is performed.

2.3.10 FM Demodulation Function (OPT73)

CAUTION: *To make accurate measurements including calibrations, let the instrument warm up for at least 30 minutes after the power has been turned on.*

7. Press **Return, Range, 1** and **kHz**.
The frequency scale (vertical axis) is set to 1 kHz/.

NOTE: *A frequency range of 500 kHz/ or more can be used if an external mixer is used. In addition, the value of RBW varies according to the frequency range used. The settable value of RBW for each frequency range is as shown in Table 2-7.*

Table 2-7 Relationship Between Frequency Range and the Value of RBW

Frequency range	RBW (The value in bold script is set when the frequency range is switched)
50 MHz/ to 500 kHz/	Cannot be set (displayed as ***)
250 kHz/ to 25 kHz/	10 MHz and 3 MHz
10 kHz/ to 1 kHz/	1 MHz , 300 kHz, 100 kHz, 30 kHz and 10 kHz

8. Press **SWEEP, SWP Time AUTO/MNL(MNL), 2, 0, 0** and **kHz(msec)**.
The time scale (horizontal axis) is set to 200 msec.
9. Press **TRIG** and **Ext Trig**.
The trigger source is switched to the external trigger.
10. Press **BW, VBW AUTO/MNL(MNL), 1** and **kHz**.
The VBW is set to 1 kHz.

FM deviation measurement

11. Press **UTILITY** and **Deviation**.
FM deviation, positive peak deviation, negative peak deviation, and repetition frequency are displayed in the lower part of the screen. In addition, the display line is displayed in the center of an FM deviation.

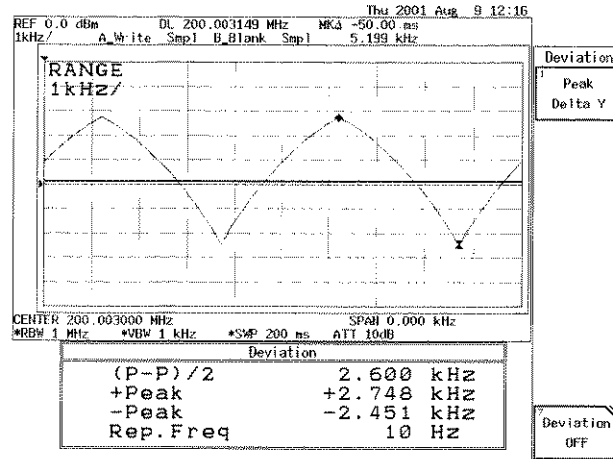

Figure 2-99 FM Deviation Measurement

12. Press **Deviation OFF**.

The FM deviation measurement function is turned off.

Sensitivity Measurement

The sensitivity measurement calculates the $\Delta F/\Delta T$ of trace data, and displays it. ΔT is determined by Aperture as shown in the formula below:

$$\Delta T = \text{Sweep time} \times \text{Aperture} [\%]$$

The unit of the vertical axis is [Hz/ms/] for a frequency range of 1 MHz/ or more, and is [Hz/s/] for a frequency range of 500 kHz/ or less. The value of the vertical axis (sensitivity range) is optimized according to the frequency range and sweep time used.

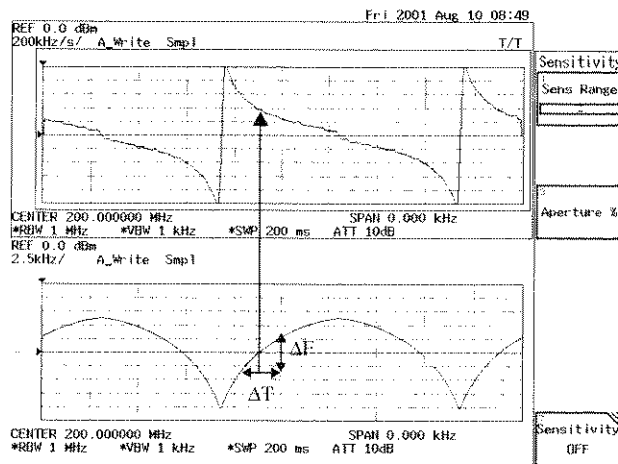

Figure 2-100 How to Calculate the Sensitivity

2.3.10 FM Demodulation Function (OPT73)

13. Press *Sensitivity* and *Sens Range*.
The trace is switched to a waveform obtained by differentiating an FM demodulated waveform.
14. Press ▼ and ▼ .
The vertical axis is magnified in two positions.
15. Press *Aperture %*, **3** and **Hz**.
The differential section along the horizontal axis is set to 3%.

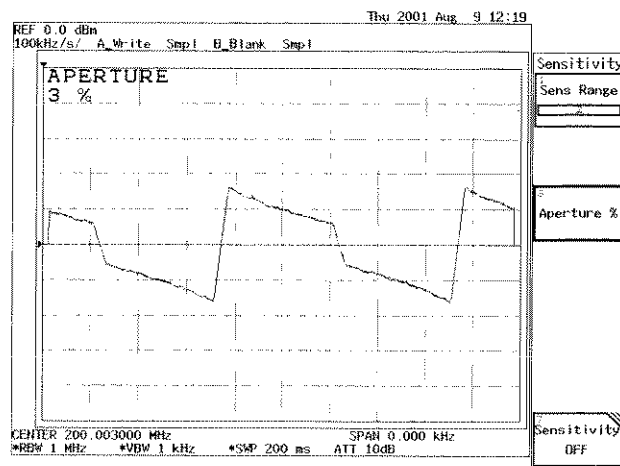

Figure 2-101 Sensitivity Measurement Screen

16. Press **DISPLAY**, *Multi Screen* and *T/T*.
The screen display is switched to Separate Screen Mode. The sensitivity is displayed in the upper part of the screen and a normal demodulation is displayed in the lower part of the screen.

NOTE: Always set the same frequency for the upper and lower screens when the sensitivity is displayed in T/T Mode.

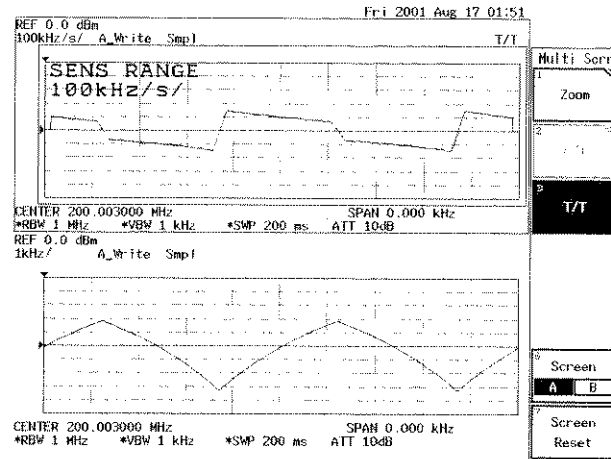

Figure 2-102 Simultaneously Displaying Sensitivity and Demodulation

17. Press **Screen Reset**.
The screen display is switched to Full Screen Mode.
18. Press **UTILITY** and **Sensitivity OFF**.
The sensitivity display function is turned off.

Linearity Measurement

The linearity measurement displays the difference between the trace and the reference line. The reference line can be set in two ways: one is to manually set with Offset and Slope, and the other is to automatically set with the Auto Adj function. In addition, if the measuring window is used, Offset and Slope are automatically adjusted to the values specified in the measuring window.

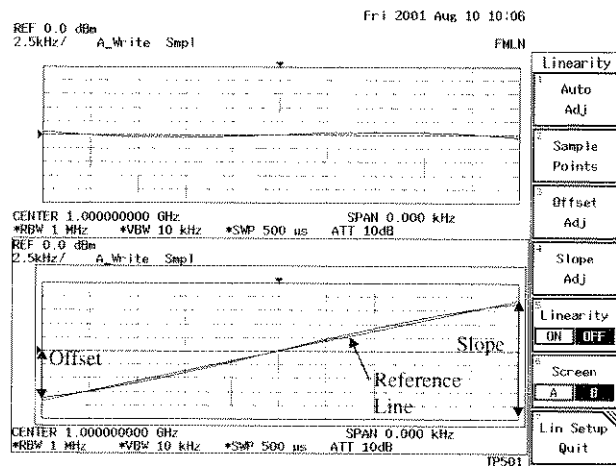

Figure 2-103 Setting Offset and Slope Used for Linearity Measurements

2.3.10 FM Demodulation Function (OPT73)

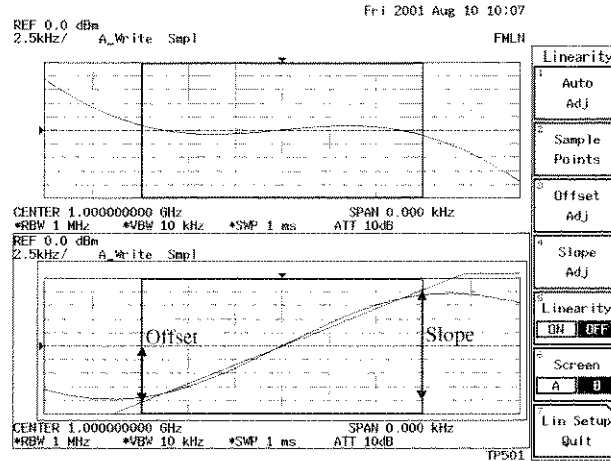

Figure 2-104 Setting Offset and Slope when Using the Measuring Window

19. Press **DISPLAY**, *Measuring Window* and *Marker Couple ON/OFF(ON)*.
The measuring window is displayed, and the range used to measure the linearity is set.
20. Press **UTILITY**, *Linearity* and *Auto Adj*.
The reference line is calculated from a trace in the measuring window using the least-square method.
21. Press *Linearity ON/OFF(ON)*.
The difference between the trace and the reference line is displayed on the screen, and the minimum and maximum differences are displayed in the lower part of the screen.

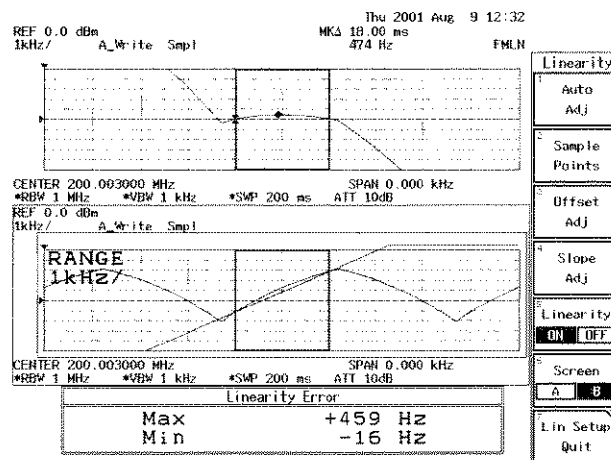

Figure 2-105 Linearity Measurement

22. Press *Lin Setup Quit*.
The screen display is switched from Separate Screen Mode to Full Screen Mode.

23. Press *Linearity ON/OFF*(OFF).
The linearity function is turned off.

2.4 Other Functions

2.4 Other Functions

2.4.1 Using Floppy Disks

The spectrum analyzer is equipped with a 3.5-inch floppy disk drive. You can save text data (settings, trace data and correction data) and BMP data (bitmap files) to floppy disks using this drive. The data on floppy disks can be accessed from personal computers.

The following floppy disk formats can be used: 3.5-inch DD 720KB, HD 1.2 MB and 1.44MB (MS-DOS format compatible).

(1) Write-protecting the Floppy Disk

This prevents you from accidentally initializing or overwriting a floppy containing previously saved data.

The write protect tab is located in the lower right hand corner of the floppy disk. To write-protect a disk, slide the tab downwards to the other end (a hole appears). To disable write protection, slide the tab upwards to the original position until the hole is no longer visible.

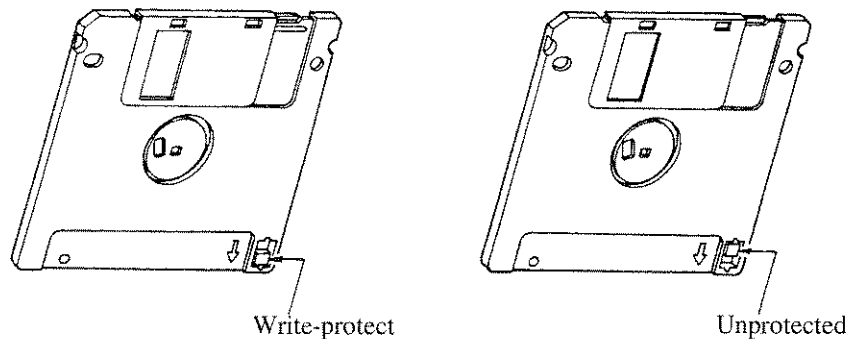

Figure 2-106 Floppy Disk Write Protection

(2) Inserting Floppy Disks

1. Insert a floppy disk into the floppy disk drive with the label surface up.

(3) Removing Floppy Disks

1. Verify that the lamp on the drive is not lit and then remove the disk.

CAUTION: *Do not remove the floppy disk while the drive lamp is lit, since this indicates that floppy disk is being accessed. If you remove the disk while the disk is being accessed, you may damage the data contained on the disk.*

2. Press the eject button.
The floppy disk is ejected from the drive.
3. Remove the disk from the drive.

(4) Initializing Floppy Disks

To prepare a floppy disk for use with the spectrum analyzer, use the following procedure.

CAUTION: *Only HD floppy disks can be formatted on this spectrum analyzer. Do not try to initialize DD floppy disks.*

1. Make sure the floppy disk is not write protected.

CAUTION: *When you format a floppy disk, all data on the floppy is erased. If you wish to save any data currently on the disk, backup the data first.*

2. Insert the floppy disk into the floppy disk drive.
3. Press **CONFIG**, **I/2_more**, and **Format FD**.
The F.Disk dialog box appears.
Confirm or Cancel can be selected using the step keys or data knob.

2.4.1 Using Floppy Disks

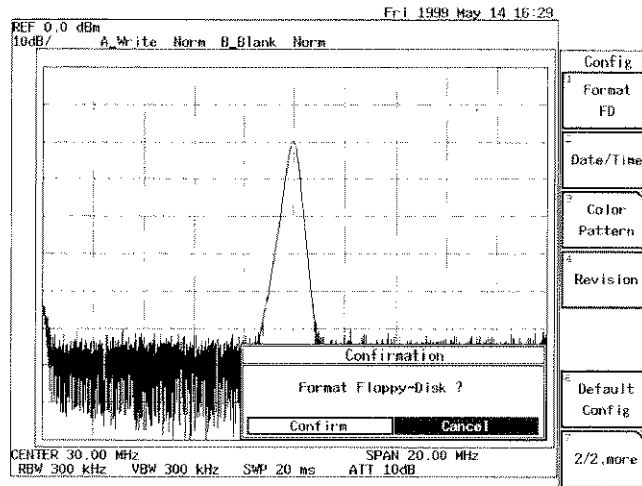

Figure 2-107 Screen for the F.Disk Menu

4. Select Confirm and then press the **ENTER(Hz)** key.
The floppy disk is formatted with the MS-DOS 1.44MB format.
While the floppy disk is being formatted, the access lamp turns on. This procedure takes approximately one minute.
5. When the spectrum analyzer does not need to be initialized, select Cancel and then press the **ENTER(Hz)** key.

2.4.2 Saving or Recalling Data

(1) Saving Data

Data which can be saved to internal memory or to a floppy disk includes the following:

- measurement conditions
- Trace data

NOTE: *Only the trace data on the screen is saved. For example, if traces A and B are displayed, both of them are saved.*

- Antenna correction data
- Normalize data
- Limit line data
- The level values for trace data
- Channel table data
- Spurious measurement table data
- Loss:Freq table data

To save data, use the following procedure:

1. Press **SHIFT** and **RECALL(SAVE)**.
The Save menu and the file list are displayed. The file list can be scrolled up or down one page at a time using the step keys.
2. Press **Device RAM/FD**.
This selects either RAM (internal memory) or FD (floppy disk) as the file destination.

NOTE: *FD cannot be selected if a floppy disk is not present in the floppy disk drive.*

2.4.2 Saving or Recalling Data

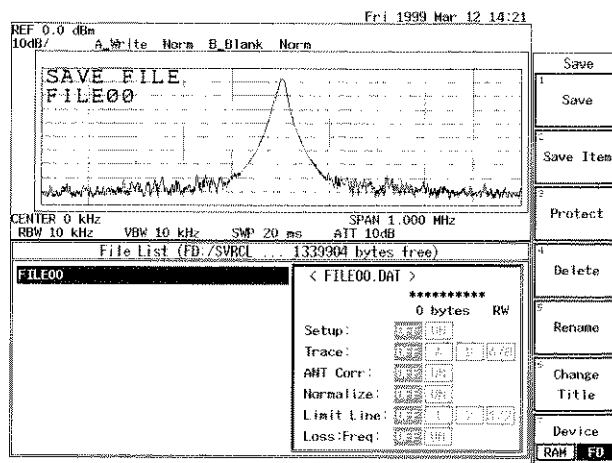

Figure 2-108 Screen Display Showing Floppy Disk as the Destination

Selecting the data to be saved

3. Press *Save Item*.

The Save Item dialog box is displayed.

4. Select the data you want to save from the Save dialog box.

Setup ON/OFF : current settings

Trace ON/OFF : Trace data being displayed

Ant Corr ON/OFF : Corrected antenna data

Norm Corr ON/OFF : Normalization calibration data (available only when equipped with OPT74).

Limit Line 1/ 2/ 1/2/ OFF:Limit Line data

Loss:Freq ON/OFF : Loss:Freq table data (Enabled only when the OPT 16, 17, 18 or 19 is installed.)

Trace Level ON/OFF : level values for the trace data (available when trace data is being saved)

Channel ON/OFF : Channel table data

Spurious ON/OFF : Spurious measurement table data

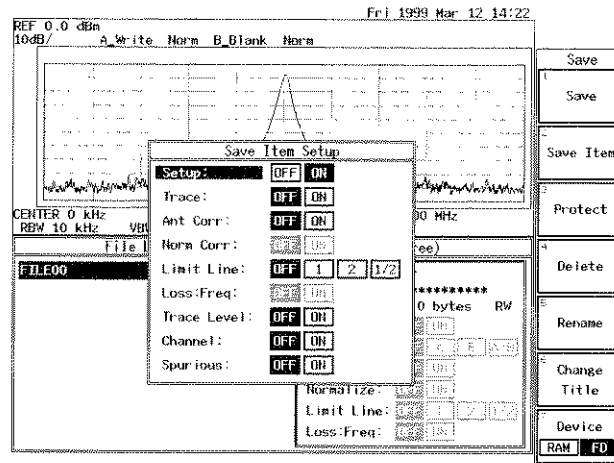

Figure 2-109 Display for Selecting the Data to be Saved

5. Press *Save Item*.
The Save menu is closed.

Choosing the file name

6. Select the file name you want to save your data under using the data knob.
When the file is being saved to RAM, the file names appear as REG00 or above.
For floppy disks, the file names start from FILE00 and continue with 01, 02 etc.

NOTE: In the above example a file number is used instead of a file name, but you can use an arbitrary file name if desired. For information on how to set file names, refer to Section 2.4.5.

Saving data

7. Press *Save*.
The data has now been saved.

2.4.2 Saving or Recalling Data

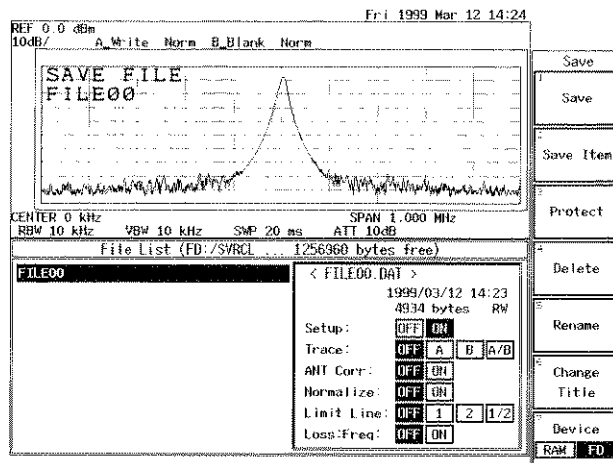

Figure 2-110 Display after Data has been Saved to a File

(2) Protecting Data

To prevent someone from accidentally initializing or overwriting data, you can use the file protection feature.

To protect files using this feature, use the following procedure:

Selecting the file source

1. Press **SHIFT** and **RECALL(SAVE)**.
The Save menu and file list are displayed.
2. Press **Device RAM/FD**.
Select either RAM (internal memory) or FD (floppy disk).

Choosing the file

3. Select the file from the file list using the data knob.

Protecting the file

4. Press **Protect**.
The selected file changes from RW (read or write) to RO (read only), indicating that data protection has been enabled.
Pressing **Protect** again disables protection, and the setting changes back to RW.

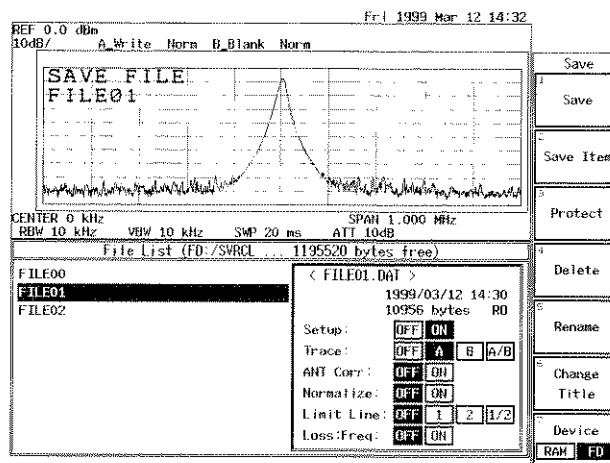

Figure 2-111 Screen Display Showing File Protection Enabled

(3) Loading Data

The saved conditions and trace data can be used for measurements. Use the following procedure to access this data.

Selecting the file source

1. Press **RECALL**.
The Recall menu and file list are displayed.
2. Press **Device RAM/FD**.
Select either RAM (internal memory) or FD (floppy disk). For this example, FD is selected.

Selecting the file

3. Select the file from the file list using the data knob.

2.4.2 Saving or Recalling Data

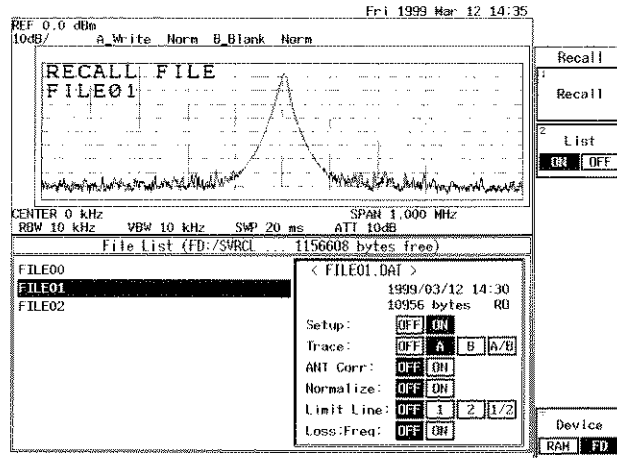

Figure 2-112 Screen Display Showing the Selected File

Recalling the data

4. Press *Recall*.
The data from the selected file is loaded into the spectrum analyzer.

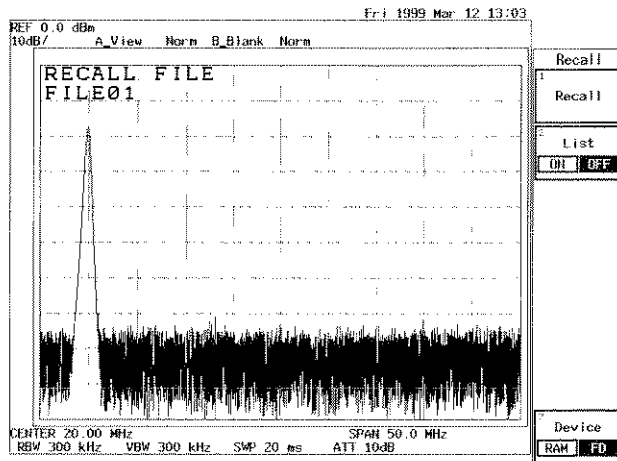

Figure 2-113 Screen Display showing Recalled Data

NOTE: When the trace data is read onto the screen, the trace mode is automatically set to the View mode.

(4) Deleting the Data

Data which has been saved to internal memory or to a floppy disk can be deleted. To delete data files, use the following procedure.

Selecting the file source

1. Press **SHIFT** and **RECALL(SAVE)**.
The Save menu and file list are displayed.
2. Press *Device RAM/FD*.
Select either RAM (internal memory) or FD (floppy disk). For this example, select FD.

Choosing the file

3. Select the file from the file list using the data knob.

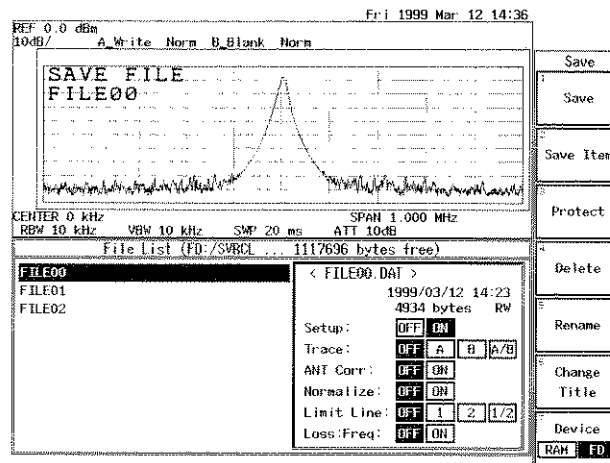

Figure 2-114 Screen as Shown when Deleting a File

Deleting the data

4. Press *Delete*.
The data in the selected file is deleted.

2.4.2 Saving or Recalling Data

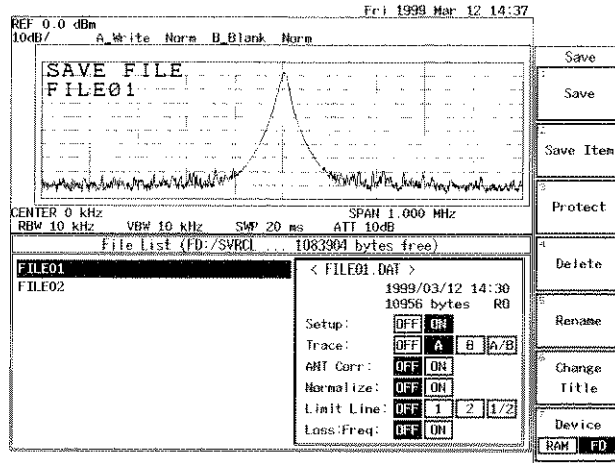

Figure 2-115 Screen as Shown after Deleting File Data

2.4.3 Outputting Screen Data

You can save screen data to a floppy disk, or print it out when needed. When outputting screen data, you can use any key except the **COPY** key. You can resume using this key after the data has been output.

(1) Saving to a Floppy Disk

Screen data is saved in BMP (bitmap file) format.

Inserting a floppy disk

1. Insert a floppy disk into the floppy drive.

Selecting the destination

2. Press **CONFIG**, *Copy Config* and *Copy Device PRT/FD*(FD). The FD is selected as the destination of the screen data.

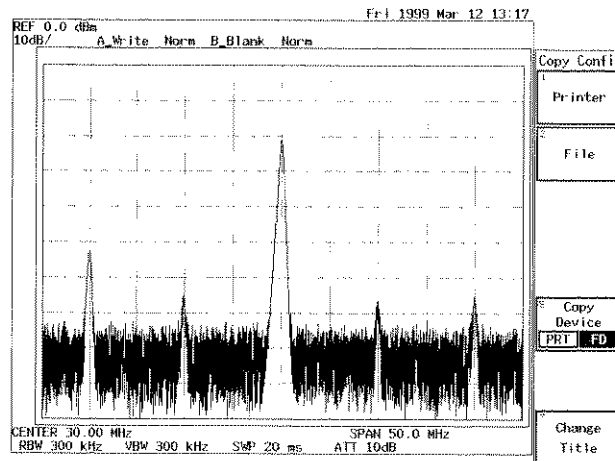

Figure 2-116 Screen Display Showing Floppy Disk as the Specified Destination

3. Press **COPY** after displaying the screen data to be saved. The access lamp remains lit while the screen data is being saved to disk, and goes out when the file has been saved.

CAUTION: *Do not remove the floppy disk while the access lamp is lit, since the floppy disk is being accessed. If you remove the disk while the disk is being accessed, you may damage the data on the disk.*

2.4.3 Outputting Screen Data

(2) Printing screen data

You can send data to a Centronix compatible printer attached to the parallel interface.

NOTE: *The output resolution of the spectrum analyzer is 180 dpi. A printer that uses a resolution which is not a multiple of 180 dpi may print with streaks.*

Compatible printers use ESC/P, ESC/P-Raster or HP PCL. Compatible printers use ESC/P, ESC/P-R or HP PCL (there may be a certain restrictions depending on the printers used).

ESC/P: Epson Standard Cord for Printer

ESC/P-R: Epson Standard Cord for Printer Raster mode

HP PCL: Hewlett Packard Printer Command Language

Suggested printers are listed in Table 2-8.

Table 2-8 Recommended Compatible Printers

Manufacturer	Model
Epson	PM-750C *1, PM-2000C, PM-770C *1, PM-800C *1, EM-900C *1, PM-780C *1, PM-880C *1, PM-900C *1
Hewlett Packard	DeskJet 694C *2, DeskJet 880C *2
Cannon	BJC-410J, BJC-420J, BJC-430J, BJ M70

NOTE: *Only ESC/P-R and HP PCL are available for color printing.*

**1 indicates that ESC/P-R is used for color printing.*

**2 indicates that HP PCL is used for color printing.*

Connecting the printer

1. Connect the printer to the PRINTER connector on the rear panel using the IBM-PC compatible cable provided.

CAUTION: *Only connect the cable after turning off both the spectrum analyzer and printer power or you may damage the analyzer.*

Selecting a destination for the screen data

2. Press **CONFIG**, *Copy Config* and *Copy Device PRT/FD(PRT)*. Screen data is sent to the printer (PRT).

Control codes and print mode setup

3. Press **CONFIG**, *Copy Config* and *Printer*. The Printer dialog box used to set the control codes and print mode appears.

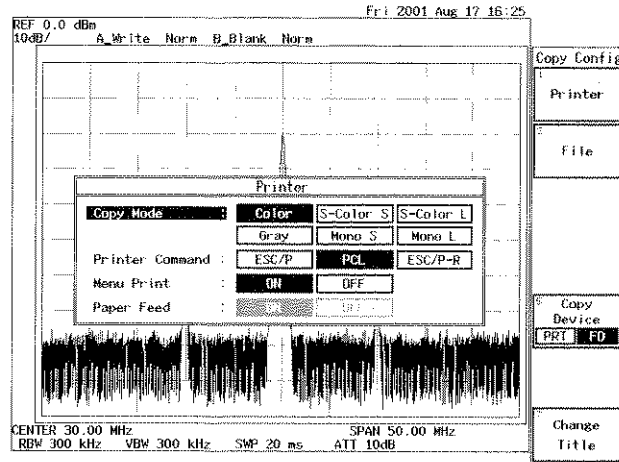

Figure 2-117 Printer Setup Screen

Printing

4. Display the screen you wish to print out, and then press **COPY**. The screen data is sent to the printer. The time required for the data to print out depends on the mode and printer used.

NOTE: Press **SHIFT**, **COPY** and **Abort** to abort printing after **Copy** has been pressed.

2.4.4 Setting Date and Time

2.4.4 Setting Date and Time

This section explains how to set the date and time for the spectrum analyzer. In the following example, a time and date of 1:35 pm Mar 18 1999 is set.

Setting the date and time

1. Press **CONFIG**, *1/2_more* and **Time/Date**.
The Time/Date dialog box appears.

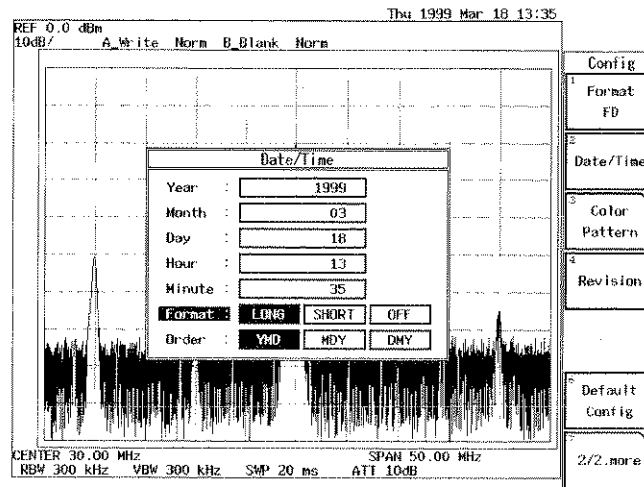

Figure 2-118 Time/Date Menu

2. Select **Year**, and press **1, 9, 9, 9** and **Hz(ENTER)**.
The year is set to 1999.
3. Select **Month**, and press **0, 3** and **Hz(ENTER)**.
The month is set to March.
4. Select **Day**, and press **1, 8** and **Hz(ENTER)**.
The date is set to the 18th.

Setting the time

5. Select **Hour**, and press **1, 3** and **Hz(ENTER)**.
The time is set to 1pm.
6. Select **Minute**, and press **3, 5** and **Hz(ENTER)**.
The time is set to 1:35pm.

Setting the date display format

7. Select **Format**, and set this function to **LONG**.
The format used to set the date is selected.
8. Select **Order** and set this function to **YMD**.
A date display mode is set.
9. Press **Date/Time**.
The Date/Time dialog box is closed.

2.4.5 Setting the Screen Title

This section describes how to enter your remarks for the screen data. A maximum of 30 characters, which consist of alphanumeric and a few special characters, can be entered.

Setting titles

1. Press **CONFIG**, **Copy Config** and **Change Title**.
The Title Entry dialog box, which is used to enter alphanumeric characters and special characters, is displayed. This dialog box consists of the two areas: one is the area in which characters entered are displayed, and the other is the area in which the alphanumeric characters to be entered are displayed as buttons. (See Figure 2-119).

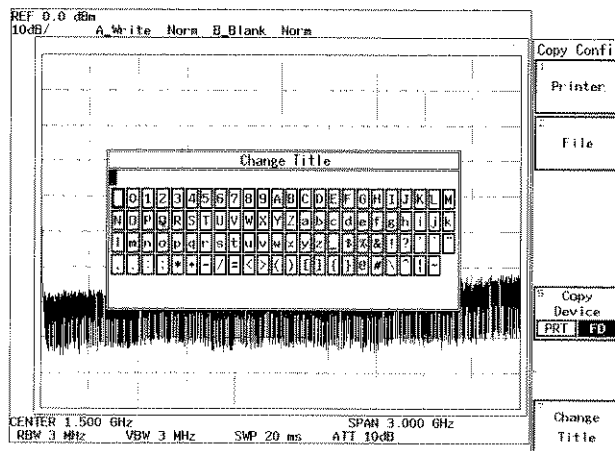

Figure 2-119 Dialog Box Used to Enter Titles

2. Select the characters you wish to enter using the data knob and step keys.
The data knob is used to move the cursor horizontally in the button area; the step keys are used to move the cursor vertically between the rows in the button area. In this example, enter ADVANTEST1 using upper case alphabetic characters.
3. Move the cursor to character A, which is found on the first line, and press the ENTER key.
Character A will be displayed in the input area within the dialog box. Note that the cursor in this area has been shifted one place to the right.

2.4.5 Setting the Screen Title

4. Select character B and press **Hz(ENTER)**. Then press **-(BK SP)**. Character B appears temporarily in the upper part and disappears when it is corrected by pressing **-(BK SP)**. Note that the cursor is next to character A on the right hand side.
5. Then enter the rest of the characters: D, V, A, N, T, E, S and T.
6. Press the numeric key **1**. Check to see if numeric character 1 has been entered after the characters ADVANTEST (the final display is ADVANTEST1). Only numeric characters can be entered directly from the numeric keys.
7. Press **Change Title**.
This closes the Title Entry dialog box, and the characters you entered are displayed in the upper left-hand corner of the screen.

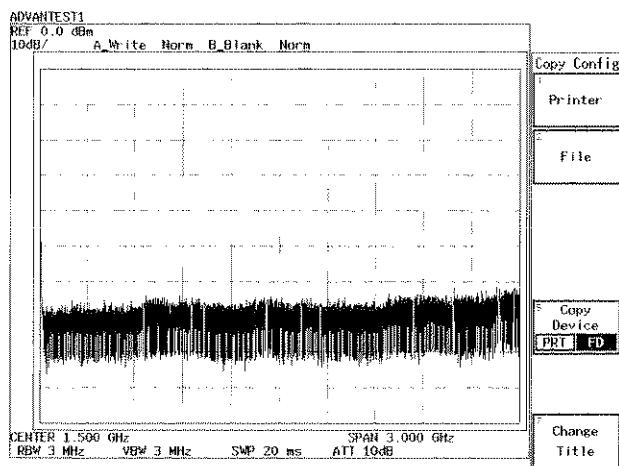

Figure 2-120 Displaying the Screen Title

CAUTION:

1. The dialog box closes, leaving the data you entered on the screen when you press any key other than the numeric keys, the **-(BS)** key or the unit keys.
2. A new title always overwrites the old one and is displayed in the specified area.

Deleting a title previously set

8. Use a null line (the entire line consists of spaces) as the title. A previously set title is deleted from the screen.

3 REFERENCE

This chapter describes the functions of all panel and soft keys.

- Menu index: Use this index as a key index to Chapter 3.
- Menu map: Shows a list of hierarchical menus on a panel key basis.
- Functional descriptions: Explains the functions of the panel and soft keys.

The panel keys are arranged in alphabetical order.

3.1 Menu Index

This menu index is used to easily find the keys described in Chapter 3.

Operation Key	Pages	Operation Key	Pages
Δ MKR \rightarrow CF	3-12, 3-53	Auto Increment	3-20, 3-74
Δ MKR \rightarrow CF Step	3-12, 3-53	AUTO TUNE.....	3-7, 3-19
Δ MKR \rightarrow MKR Step.....	3-12, 3-53	Auto Tune	3-10, 3-38
Δ MKR \rightarrow Span.....	3-12, 3-53	Average CONT/SGL	3-17, 3-78, 3-79
$\sqrt{\text{Nyquist}}$ Filter	3-59, 3-61	Average Loss ON/OFF	3-10, 3-39
$\sqrt{\text{Nyquist}}$ Filter ON/OFF.....	3-14, 3-59, 3-61	Average Power.....	3-14, 3-58
$\sqrt{\text{Nyquist}}$ Filter Setup.....	3-14, 3-59, 3-61	Average PSE/CONT	3-17, 3-77, 3-78
% AM Meas ON/OFF.....	3-11, 3-46	Average Times.....	3-14, 3-57
% AM Video ON/OFF.....	3-11, 3-46	Average Times ON/OFF.....	3-11, 3-48, 3-49
10dB/div.....	3-10, 3-42	AVG A(B).....	3-17, 3-77
10M Ref INT/EXT.....	3-8, 3-26	AVG A(B) ON/OFF	3-17, 3-77
1dB/div.....	3-10, 3-42	B&W	3-8, 3-28
2dB/div.....	3-10, 3-42	B-A \rightarrow A.....	3-17, 3-79
3rd Order.....	3-11, 3-49	Band Lock ON/OFF.....	3-10, 3-39
3rd Order Meas	3-11, 3-46	Band Select	3-10, 3-38
5dB/div.....	3-10, 3-42	Baud Rate.....	3-8, 3-23
5th Order	3-11, 3-49	BBA9106	3-9, 3-34
7th Order	3-11, 3-49	Blank A(B).....	3-17, 3-77
9th Order	3-11, 3-49	BS Window ON/OFF.....	3-14, 3-59, 3-61
A-B \rightarrow A.....	3-17, 3-79	BW	3-7, 3-20
Abort	3-7, 3-29	C/N Meas	3-11, 3-47
ACP.....	3-14, 3-58	C/N Meas OFF.....	3-11, 3-48
ACP OFF	3-14, 3-60	CAL	3-7
Active Marker	3-12, 3-14, 3-52, 3-60	Cal 10MHz Ref.....	3-21
A-DL \rightarrow A	3-17, 3-79	Cal All.....	3-7, 3-21
All	3-18, 3-84	Cal Corr ON/OFF	3-7, 3-21
AMPTD OFS	3-7, 3-21	Cal Sig Level	3-7, 3-21
Annotation ON/OFF	3-8, 3-26	Carrier	3-37
Ant Corr	3-16, 3-69	Center.....	3-10, 3-36
Aperture %	3-18, 3-83	CF Step AUTO/MNL	3-10, 3-36
ATT AUTO/MNL.....	3-10, 3-42	CH Power OFF	3-14, 3-57
Auto Adj	3-18, 3-83		
Auto All	3-7, 3-16,		

3.1 Menu Index

CH Type 1 Edit.....	3-10, 3-37	Delete Line.....	3-9, 3-10,
CH Type 2 Edit.....	3-10, 3-37		3-13, 3-14,
Change Title.....	3-8, 3-16,		3-34, 3-38,
	3-26, 3-70		3-39, 3-55,
Channel.....	3-16, 3-37,		3-59, 3-61
	3-70	Delta.....	3-12, 3-50
Channel Power.....	3-14, 3-57	Demod Cal.....	3-18, 3-84
Channel Setting.....	3-10, 3-36	Detector.....	3-17, 3-77
Coarse.....	3-21	Detector Mode.....	3-9, 3-33
Color 1.....	3-8, 3-27	Deviation.....	3-18, 3-83
Color 2.....	3-8, 3-27	Deviation OFF.....	3-18, 3-83
Color Pattern.....	3-8, 3-27	Device RAM/FD.....	3-15, 3-16,
Compression.....	3-8, 3-25		3-67, 3-70
CONFIG.....	3-8, 3-23	Disp Line ON/OFF.....	3-9, 3-17,
Cont Down ON/OFF.....	3-11, 3-45		3-31, 3-79
Cont Peak ON/OFF.....	3-12, 3-50	DISPLAY.....	3-9, 3-31
COPY.....	3-8, 3-29	Each Item.....	3-7, 3-21
Copy Config.....	3-8, 3-23	Edit Table.....	3-11, 3-14,
Copy Device PRT/FD.....	3-8, 3-26		3-47, 3-62,
Copy Mode.....	3-8, 3-24,		3-64
	3-25	EMC.....	3-9
Copy Table 1 to 2.....	3-13, 3-55	EMCO3142.....	3-9, 3-34
Copy Table 2 to 1.....	3-13, 3-55	Execute Normalize.....	3-17, 3-76
Corr Mode ANT/LVL.....	3-9, 3-34	Execute Self Test.....	3-16, 3-71
Corr OFF.....	3-9, 3-34	Exit.....	3-16, 3-71
COUNTER.....	3-9, 3-30	Ext.....	3-16, 3-74
Counter OFF.....	3-9, 3-30	Ext Gate In ON/OFF.....	3-16, 3-75
CS/BS Setup.....	3-14, 3-58,	Ext Mixer Config.....	3-10, 3-38
	3-61	Ext Trig.....	3-17, 3-81
Data Length.....	3-8, 3-23	F/T.....	3-9, 3-32
Date/Time.....	3-8, 3-27	Field.....	3-9, 3-33
Day.....	3-8, 3-27	File.....	3-8, 3-25
dB/div.....	3-10, 3-42	File Format.....	3-8, 3-25
dBc/Hz.....	3-11, 3-45	File No.....	3-8, 3-25
dBm.....	3-10, 3-42	Fine.....	3-22
dBm/Hz.....	3-11, 3-45	Fixed MKR ON/OFF.....	3-12, 3-51
dBmV.....	3-10, 3-42	Flow Control.....	3-8, 3-23
dBµV.....	3-10, 3-42	FM Demod.....	3-18, 3-83
dBµV/√Hz.....	3-11, 3-45	FM Demod OFF.....	3-18, 3-84
Default.....	3-14, 3-22,	FM Meas.....	3-11, 3-46
	3-57, 3-58,	FM Meas OFF.....	3-11, 3-47
	3-60, 3-62	Format.....	3-8, 3-27
Default Config.....	3-8, 3-28,	Format FD.....	3-8, 3-26
	3-89	Free Run.....	3-17, 3-81
Define → Default.....	3-14, 3-57,	FREQ.....	3-10, 3-36
	3-58, 3-60,	Freq Adj Auto.....	3-17, 3-76
	3-62	Freq Adj Manual.....	3-17, 3-76
Delete.....	3-11, 3-14,	Freq Corr ON/OFF.....	3-7, 3-21
	3-15, 3-16,	Freq Offset ON/OFF.....	3-10, 3-36
	3-47, 3-63,	Frequency Input.....	3-10, 3-36
	3-64, 3-70	Full Span.....	3-16, 3-73

Gate Position.....	3-16, 3-75	3-58, 3-60,
Gate Setup Quit.....	3-16, 3-75	3-62
Gate Source.....	3-16, 3-74	Manual Tune.....
Gate Width.....	3-16, 3-75	3-10, 3-38
Gated Sweep.....	3-16, 3-74	Marker Couple ON/OFF.....
Gated Sweep ON/OFF.....	3-16, 3-75	3-9, 3-31
GPIB.....	3-8, 3-23	Marker No.....
GPIB Address.....	3-8	3-12, 3-14,
Graph.....	3-14, 3-60	3-51, 3-60
Graph OFF.....	3-14, 3-60	Marker OFF.....
Gray.....	3-8, 3-28	3-12, 3-14,
Hi Sens (IM Meas) ON/OFF.....	3-11, 3-49	3-51, 3-52,
Hi Sens ON/OFF.....	3-10, 3-42	3-60
HOLD.....	3-10	Marker ON.....
Hour.....	3-8, 3-27	3-12, 3-14,
IF Step Amp.....	3-7, 3-21	3-51, 3-60
IM Meas.....	3-11, 3-49	Marker Pause Time.....
IM Meas OFF.....	3-11, 3-49	3-9, 3-11,
Image Suppress ON/OFF.....	3-10, 3-39	3-34, 3-47
Input 50Ω/75Ω.....	3-10, 3-43	Math A.....
Input Type.....	3-10, 3-36	3-17, 3-79
Insert.....	3-11, 3-14,	Max Hold A(B).....
	3-15, 3-47,	3-17, 3-77
	3-63, 3-64	MEAS.....
Insert Line.....	3-9, 3-10,	3-11, 3-45
	3-13, 3-14,	Measuring Window.....
	3-34, 3-37,	3-9, 3-31
	3-39, 3-55,	Menu Print.....
	3-59, 3-61	3-8, 3-24
Inverse.....	3-8, 3-28	Min Hold A(B).....
Last Span.....	3-16, 3-73	3-17, 3-79
LEVEL.....	3-10, 3-42	Min Peak.....
Limit Line.....	3-16, 3-70	3-12, 3-50
Limit Line 1/2.....	3-13, 3-55	Minute.....
Limit Line Edit.....	3-13, 3-55	3-8, 3-27
Limit Setup.....	3-11, 3-49	Mixer INT/EXT.....
Lin Setup Quit.....	3-18, 3-83	3-10, 3-38
Line.....	3-17, 3-81	MKR.....
Line1 ON/OFF.....	3-13, 3-54	3-12, 3-50
Line2 ON/OFF.....	3-13, 3-54	MKR List ON/OFF.....
Linear.....	3-10, 3-42	3-12, 3-52
Linearity.....	3-18, 3-83	MKR Read DLT/LFT/RHT.....
Linearity ON/OFF.....	3-18, 3-83,	3-11, 3-45
	3-84	MKR Step AUTO/MNL.....
List ON/OFF.....	3-15, 3-67	3-12, 3-51
LOCAL.....	3-10, 3-44	MKR Trace A/B.....
Log Linear.....	3-7, 3-21	3-12, 3-51
Loss:Freq.....	3-16, 3-70	MKR →.....
Loss:Freq Edit.....	3-10, 3-39	3-12, 3-53
Loss:Freq ON/OFF.....	3-10, 3-39	MKR → CF.....
Manual.....	3-14, 3-57,	3-12, 3-53
		MKR → CF Step.....
		3-12, 3-53
		MKR → MKR Step.....
		3-12, 3-53
		MKR → Ref.....
		3-12, 3-53
		Mod Freq → SWP T ON/OFF.....
		3-11, 3-46
		Month.....
		3-8, 3-27
		Multi Marker.....
		3-12, 3-51
		Multi MKR OFF.....
		3-12, 3-52
		Multi MKR Setup.....
		3-12, 3-51
		Multi Screen.....
		3-9, 3-31
		Nega.....
		3-17, 3-77
		Next Peak.....
		3-12, 3-50
		Next Peak Left.....
		3-12, 3-50
		Next Peak Max-Min.....
		3-12, 3-50
		Next Peak Right.....
		3-12, 3-50
		Next Result.....
		3-14, 3-15,
		3-63, 3-64
		Noise/Hz.....
		3-11, 3-45
		Noise/Hz OFF.....
		3-11, 3-45
		Norm Corr.....
		3-16, 3-69
		Norm Corr ON/OFF.....
		3-17, 3-76
		Normal.....
		3-9, 3-12,
		3-17, 3-33,

3.1 Menu Index

	3-50, 3-77	RBW 9kHz.....	3-9, 3-33
OBW	3-14, 3-58	RBW Auto	3-9, 3-33
OBW OFF.....	3-14, 3-58	RBW AUTO/MNL	3-7, 3-20
OBW%.....	3-14, 3-58	RBW Switch	3-7, 3-21
Offset Adj	3-18, 3-83	RECALL	3-15, 3-67
Order	3-8, 3-11,	Recall	3-15, 3-67
	3-27, 3-49	Ref Level.....	3-10, 3-42
Paper Feed.....	3-8, 3-25	Ref Line	3-17, 3-76
Parameter Setup	3-14, 3-57,	Ref Line ON/OFF	3-9, 3-31
	3-58, 3-60,	Ref Offset ON/OFF	3-10, 3-43
	3-62	Rename	3-16, 3-70
Parity Bit	3-8, 3-23	REPEAT	3-15, 3-68
PAS/FAIL	3-13, 3-54	Res 100Hz.....	3-9, 3-30
PASS Judge UP/LOW	3-14, 3-63,	Res 10Hz.....	3-9, 3-30
	3-65	Res 1Hz.....	3-9, 3-30
Pass/Fail Judgement ON/OFF	3-49	Res 1kHz.....	3-9, 3-30
Pass/Fail ON/OFF.....	3-13, 3-54	Reset Marker.....	3-12, 3-14,
PBW	3-7, 3-21		3-52, 3-60
Peak	3-9, 3-33	Results REL/ABS	3-14, 3-61
Peak Delta Y	3-11, 3-12,	Revision	3-8, 3-28
	3-18, 3-47,	Rolloff Factor.....	3-14, 3-59,
	3-50, 3-83		3-61
Peak List Freq	3-12, 3-52	RS232.....	3-8, 3-23
Peak List Level	3-12, 3-52	Sample	3-17, 3-77
Peak Menu	3-12, 3-50	Sample Points	3-18, 3-83
Peak Zoom	3-16, 3-73	SAVE.....	3-16
Peak → CF.....	3-12, 3-53	Save.....	3-16, 3-69
Peak → Ref.....	3-12, 3-53	Save Item	3-16, 3-69
Phase Jitter	3-11, 3-48	Screen A/B.....	3-9, 3-16,
Phase Jitter OFF.....	3-11, 3-48		3-18, 3-32,
Phase Noise.....	3-11, 3-47		3-75, 3-83
PK SRCH.....	3-13, 3-56	Screen FULL/SEPA/CARRIER	3-14, 3-59
Points 1001/501	3-8, 3-26	Screen Reset.....	3-9, 3-32
Posi.....	3-17, 3-77	Search ALL/UP/LOW	3-12, 3-50
Power AVG A(B)	3-17, 3-78	Self Test	3-16
Power AVG A(B) ON/OFF	3-17, 3-78	Sens Range.....	3-18, 3-83
Power Meas OFF	3-14, 3-58	Sensitivity	3-18, 3-83
POWER MEASURE	3-14, 3-57	Sensitivity OFF.....	3-18, 3-83
Presel.....	3-10, 3-38	Setup	3-16, 3-69
PRESET	3-15	SHIFT	3-10, 3-41
Prev Result.....	3-14, 3-15,	Shift X/Y.....	3-13, 3-55
	3-63, 3-64	SHIFT, 0(Self Test)	3-16, 3-71
Printer.....	3-8, 3-23	SHIFT, 1(EMC)	3-9, 3-33
Printer Command.....	3-8, 3-24	SHIFT, 7(CAL).....	3-7, 3-21
Protect	3-16, 3-70	SHIFT, CONFIG(PRESET)	3-15, 3-66,
QP	3-9, 3-33		3-85
Range	3-18, 3-83	SHIFT, COPY, Abort	3-7, 3-29
Range Only	3-18, 3-84	SHIFT, RECALL(SAVE).....	3-16, 3-69
RBW 120kHz.....	3-9, 3-33	Show Result	3-14, 3-63,
RBW 1MHz.....	3-9, 3-33		3-64
RBW 200Hz.....	3-9, 3-33	Sig Track ON/OFF.....	3-11, 3-12,

	3-47, 3-48, 3-51	3-14, 3-15, 3-34, 3-38, 3-39, 3-47, 3-55, 3-59, 3-61, 3-63, 3-64
Signal Ident ON/OFF	3-10, 3-39	
SINGLE	3-16, 3-72	
Single Measure ON/OFF	3-14, 3-17, 3-65, 3-78, 3-79	
Slope (TV Polarity) +/-	3-16, 3-17, 3-74, 3-81	Table No. 1/2/3
Slope +/-	3-17, 3-81	3-14, 3-15, 3-62, 3-64
Slope Adj	3-18, 3-83	TG
Sort	3-9, 3-10, 3-13, 3-14, 3-34, 3-38, 3-39, 3-55, 3-59, 3-61	3-17, 3-76
Sound	3-9, 3-11, 3-34, 3-47	TG Level
Sound AM/FM	3-9, 3-11, 3-34, 3-47	3-17, 3-76
Sound OFF	3-11, 3-35, 3-47	TG OFF
SPAN	3-16, 3-73	3-17, 3-76
Spectrum Mask	3-14, 3-60	Total Gain
Spectrum Mask OFF	3-14, 3-62	3-7, 3-21
Spurious	3-16, 3-70	Total Power
Spurious Freq	3-14, 3-62	3-14, 3-57
Spurious Freq OFF	3-14, 3-63	TR1722
Spurious Time	3-14, 3-64	3-9, 3-33
Spurious Time OFF	3-14, 3-65	TRACE
Squelch ON/OFF	3-9, 3-11, 3-34, 3-47	3-17, 3-77
Start	3-10, 3-36	Trace
Start CH Shift	3-10, 3-37	3-16, 3-69
Start Offset	3-11, 3-48	Trace Level
Stop	3-10, 3-36	3-16, 3-70
Stop Bit	3-8, 3-23	Trc Menu A/B
Stop CH Shift	3-10, 3-37	3-17, 3-77, 3-80
Stop Offset	3-11, 3-48	TRIG
Store	3-22	3-17, 3-81
Store A(B) to B(A)	3-17, 3-79	Trig Delay
SWEEP	3-16, 3-74	3-16, 3-17, 3-74, 3-81
Sweep Count ON/OFF	3-14, 3-63, 3-64	Trig Source
SWP Time AUTO/MNL	3-16, 3-74	3-17, 3-81
Symbol Rate 1/T	3-14, 3-59, 3-61	TV Sys NTSC/PAL&SECAM
T/T	3-9, 3-32	3-17, 3-82
Table 1 to 3	3-37	TV-H
Table Init	3-9, 3-10, 3-11, 3-13,	3-16, 3-17, 3-74, 3-81
		TV-V
		3-16, 3-17, 3-74, 3-81
		UHALP9107
		3-9, 3-33
		Units
		3-10, 3-42
		User ANT Corr
		3-9, 3-34
		VBW AUTO/MNL
		3-7, 3-20
		Video Trig
		3-17, 3-81
		View A(B)
		3-17, 3-77
		Volts
		3-10, 3-42
		Volume
		3-9, 3-11, 3-34, 3-47
		Watts
		3-10, 3-42
		Wide RBW ON/OFF
		3-7, 3-20
		Window ON/OFF
		3-9, 3-31
		Window Position
		3-9, 3-14, 3-31, 3-57
		Window Sweep ON/OFF
		3-9, 3-31
		Window Width
		3-9, 3-14, 3-31, 3-57
		Write A(B)
		3-17, 3-77
		X ABS/LFT/CTR
		3-13, 3-54
		XdB Down
		3-11, 3-45
		XdB Left
		3-11, 3-45
		XdB Right
		3-11, 3-45
		Y ABS/CTR
		3-13, 3-54

3.1 Menu Index

Y ABS/TOP/BOT	3-13, 3-54
Year	3-8, 3-27
Zero Span	3-16, 3-73
Zoom	3-9, 3-32
Zoom Position	3-9, 3-32
Zoom Width	3-9, 3-32

3.2 Menu Map

Abort (SHIFT, COPY)

[Abort

AUTO
TUNE

[]

BW

[RBW AUTO/MNL
VBW AUTO/MNL
Wide RBW ON/OFF
Auto All

CAL (SHIFT, 7)

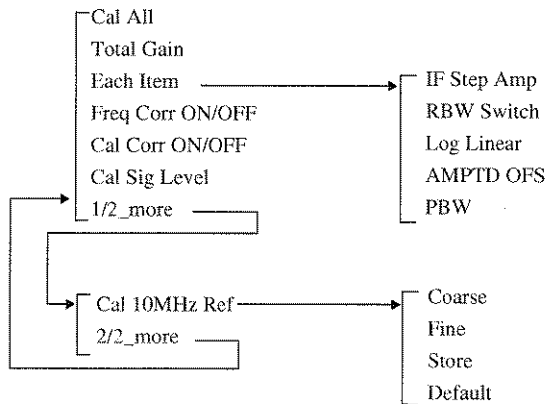

3.2 Menu Map

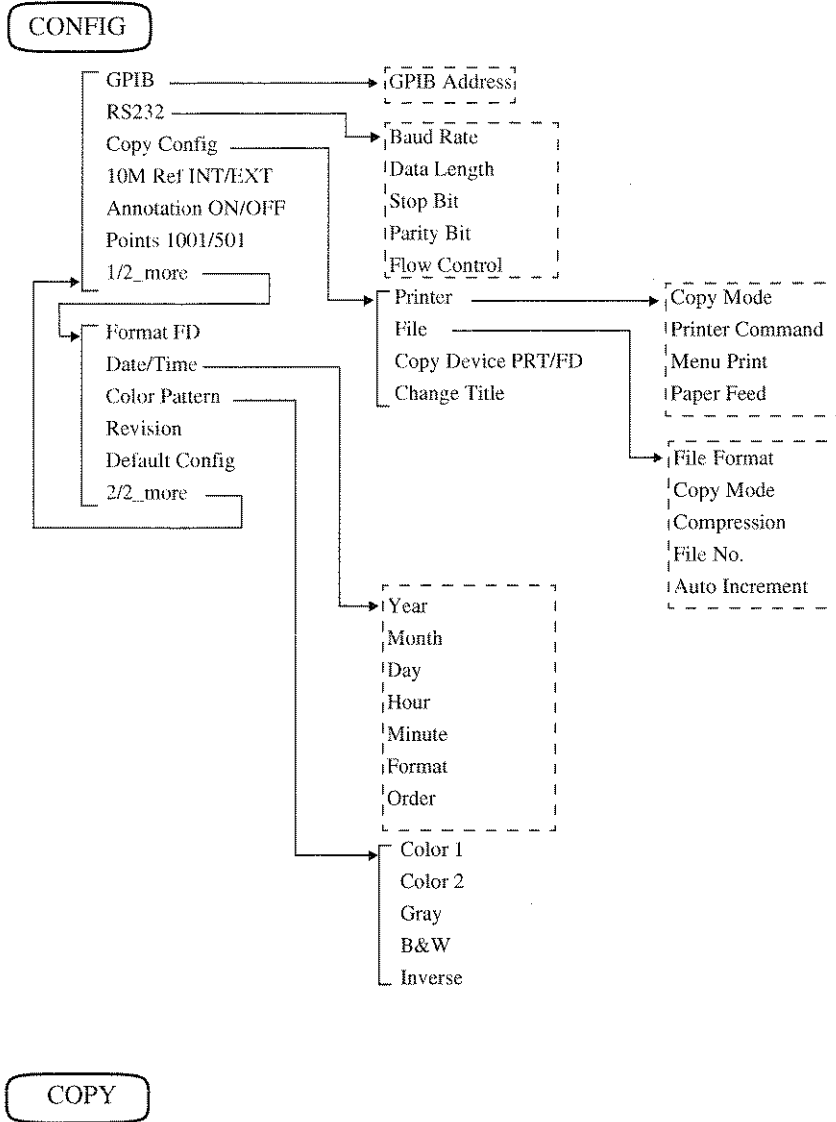

COUNTER



- Res 1kHz
- Res 100Hz
- Res 10Hz
- Res 1Hz
- Counter OFF

DISPLAY

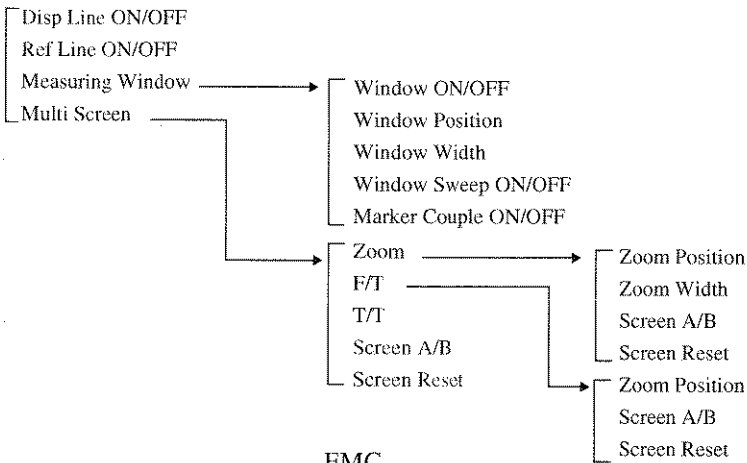
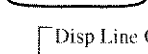

EMC (SHIFT , EMC 1)

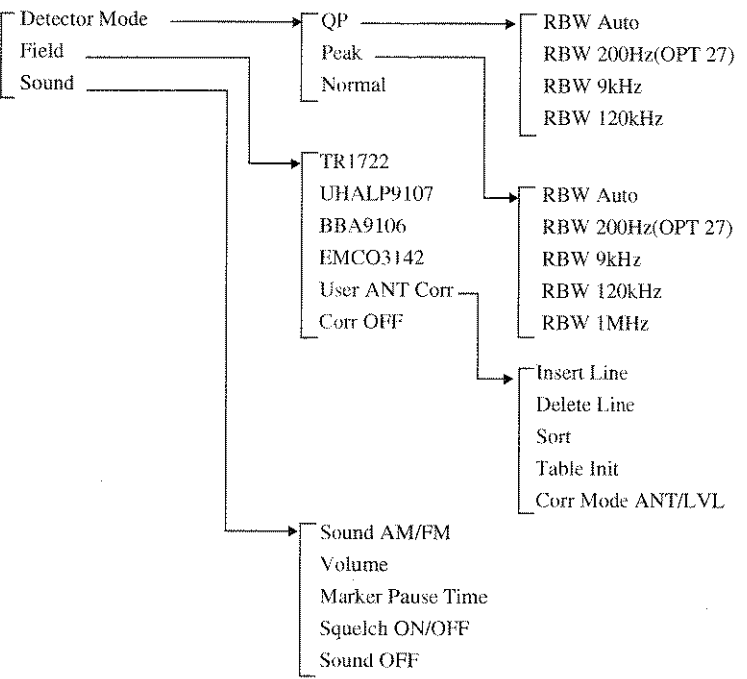

3.2 Menu Map

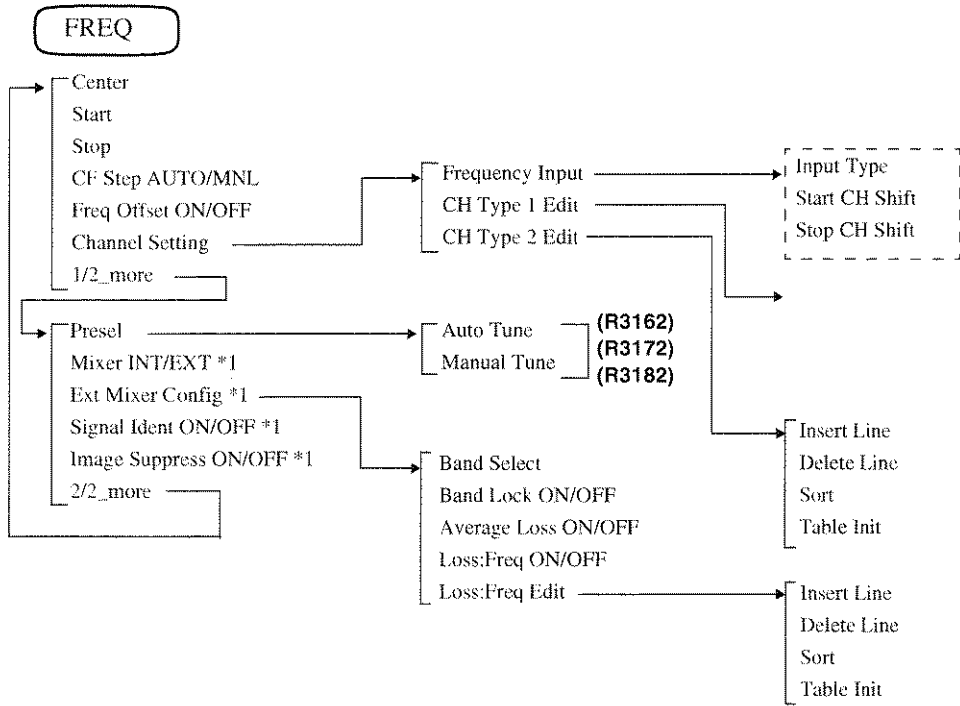

*1: Compatible with OPT16 thru OPT19 only

HOLD (SHIFT)

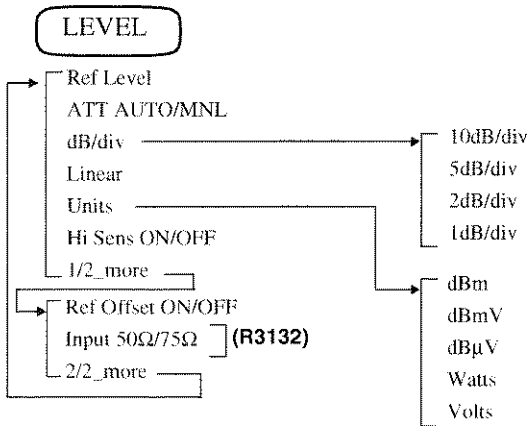

LOCAL

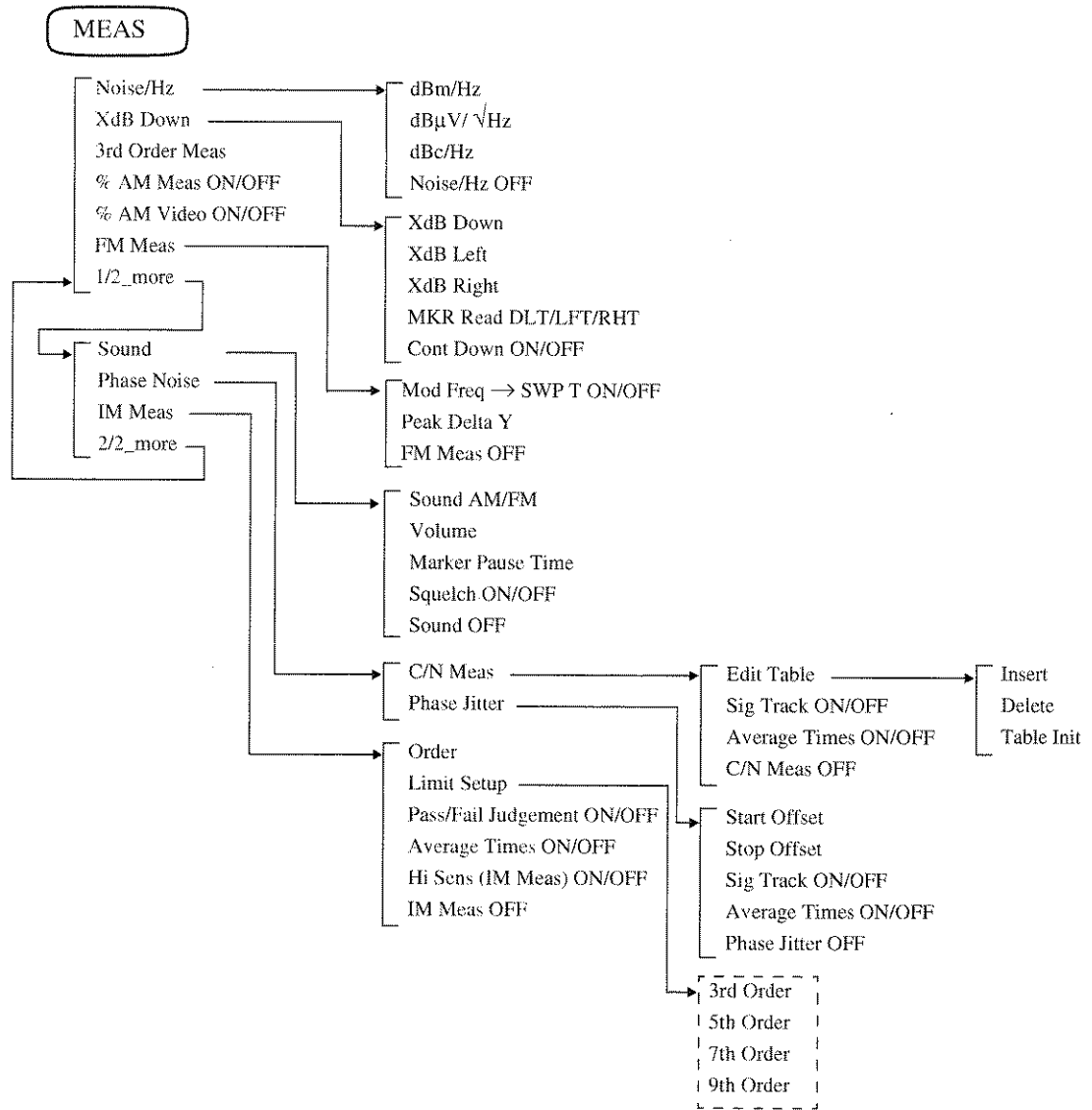

3.2 Menu Map

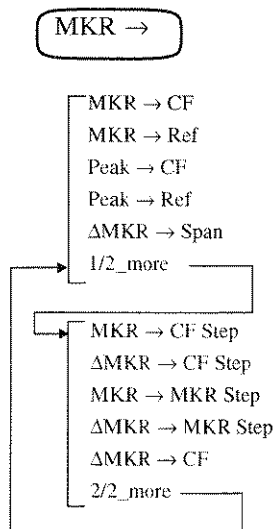
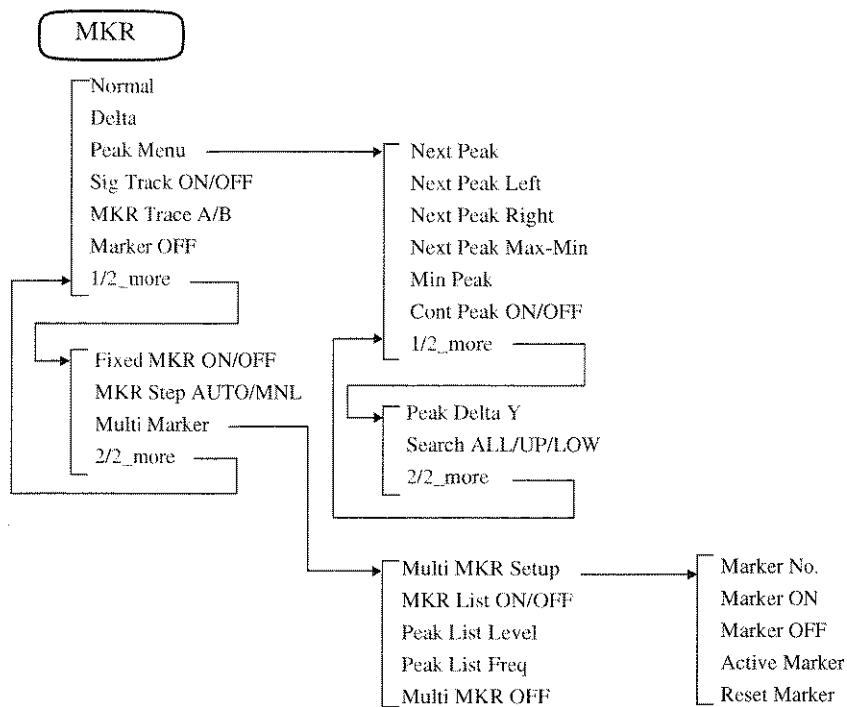

PAS/FAIL

- Pass/Fail ON/OFF
- Line1 ON/OFF
- Line2 ON/OFF
- X ABS/LFT/CTR
- Y ABS/TOP/BOT
- (Y ABS/CTR: When OPT73, FM Demodulation function, is turned on.)
- Shift X/Y
- Limit Line Edit

- Limit Line 1/2
- Insert Line
- Delete Line
- Sort
- Table Init
- Copy Table 1 to 2
- Copy Table 2 to 1

PK SRCH

3.2 Menu Map

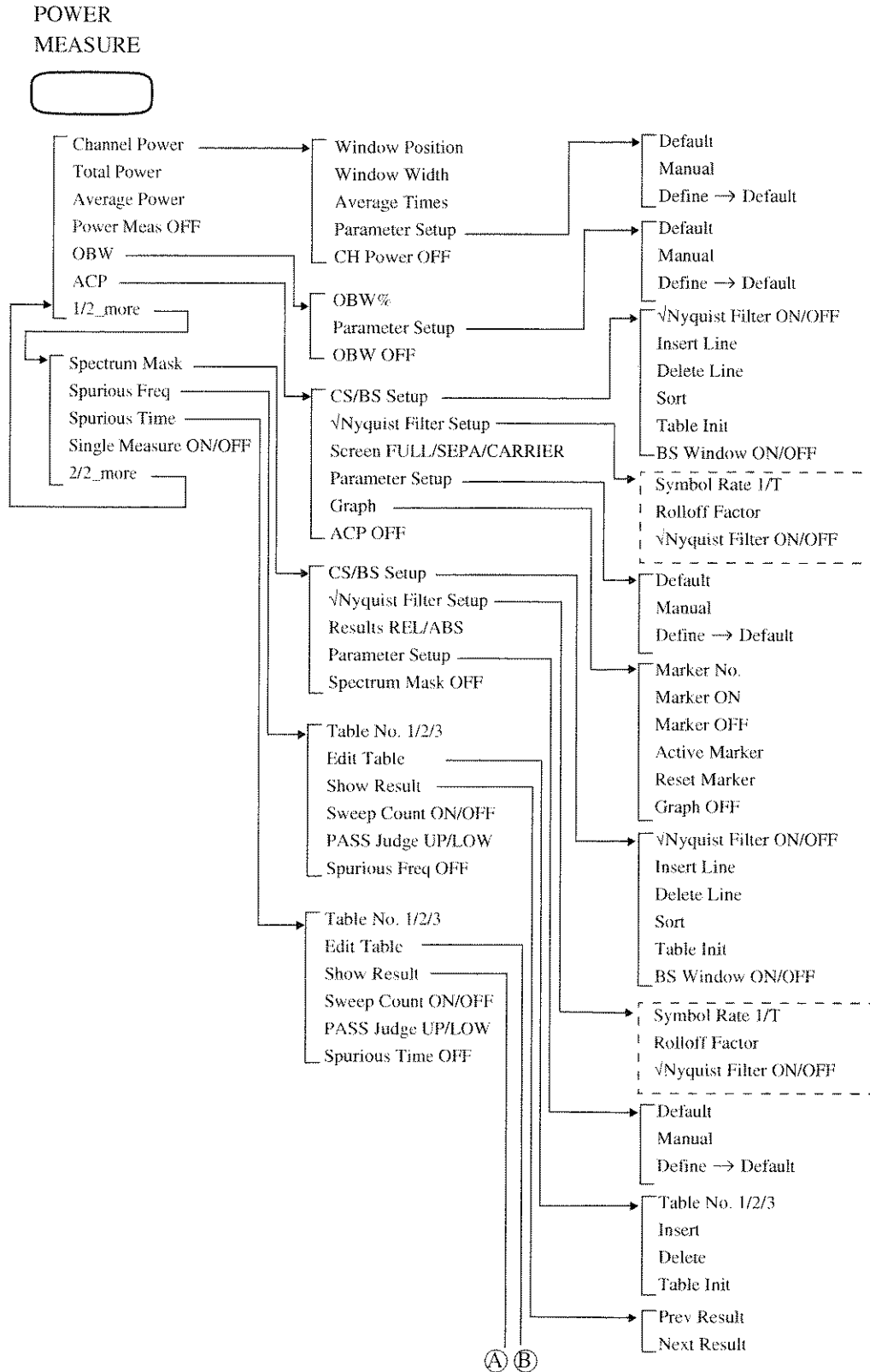

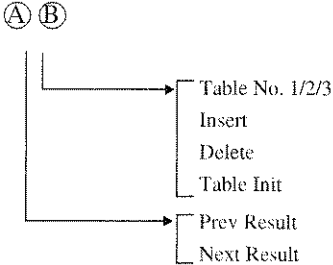

PRESET (SHIFT , PRESET CONFIG)

RECALL

- Recall
- List ON/OFF
- Device RAM/FD

REPEAT

3.2 Menu Map

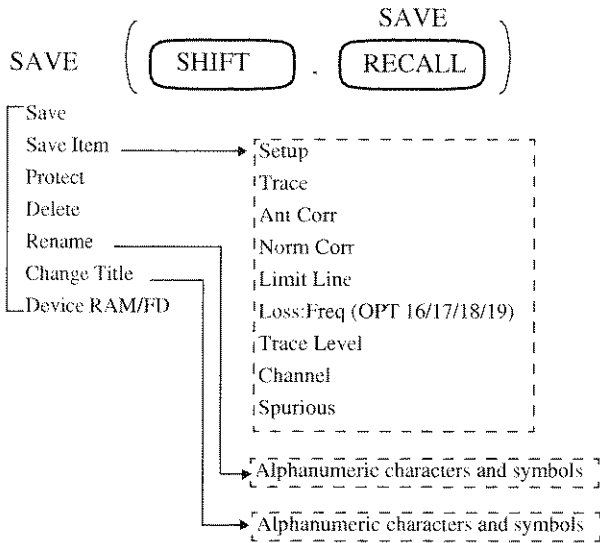

- Execute Self Test
- Exit

SINGLE

SPAN

- Full Span
- Zero Span
- Peak Zoom
- Last Span

SWEEP

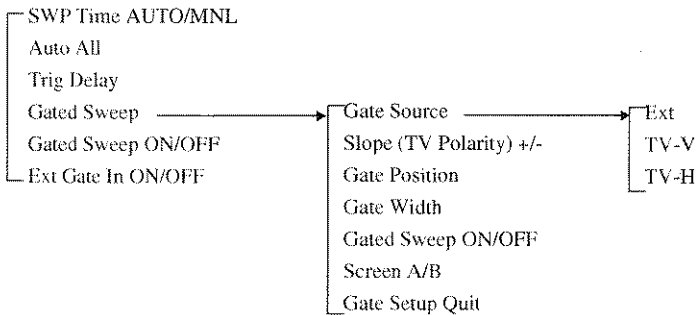

TG (OPT 74)

- TG Level
- Execute Normalize
- Norm Corr ON/OFF
- Ref Line
- Freq Adj Auto
- Freq Adj Manual
- TG OFF

TRACE

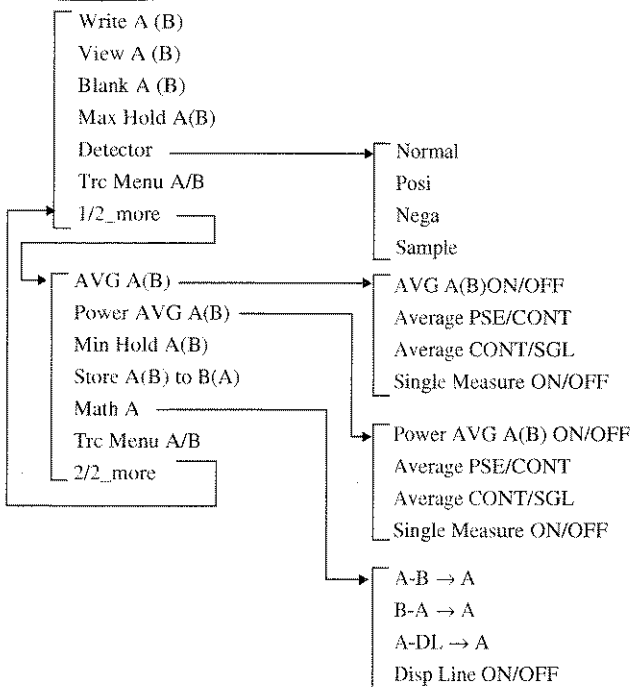

TRIG

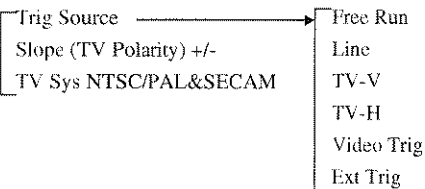

- Free Run
- Line
- Video Trig
- Ext Trig
- Slope +/-
- Trig Delay

When OPT73, FM Demodulation function, is turned on.

3.2 Menu Map

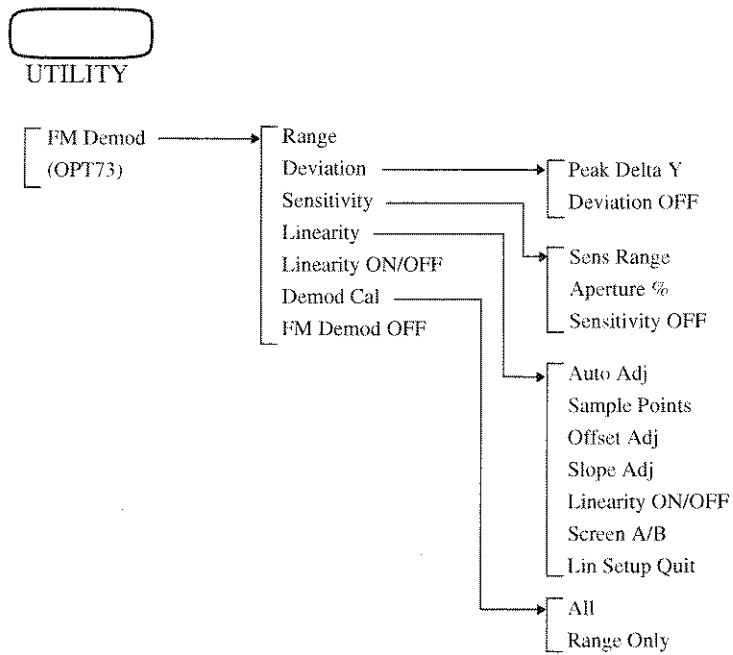

3.3 Menu Function Descriptions

This section describes all panel keys and any associated menus displayed when they are pressed.

3.3.1 AUTO TUNE Key (Auto Tuning)

When pressing the **AUTO TUNE** key, the frequency span is automatically changed to the full span to detect the maximum signal level and changed back to the last span.

Then, the reference level is changed to the detected maximum level.

(Note there is no menu associated with this panel key.)

NOTE: *To terminate the tuning, press any keys other than the COPY, LOCAL, SINGLE and REPEAT keys.*

3.3.2 BW Key (Bandwidth)

3.3.2 BW Key (Bandwidth)

Pressing the **BW** key displays the BW menu that allows you to select resolution bandwidth (RBW) and video bandwidth (VBW) parameters.

For example, when MNL is selected for the resolution bandwidth, the resolution bandwidth can be specified.

<i>RBW AUTO/MNL</i>	Toggles the video bandwidth between AUTO and MNL.
AUTO:	Automatically sets an optimum resolution bandwidth according to the span settings.
MNL:	Allows you to set the resolution bandwidth manually.
<i>VBW AUTO/MNL</i>	Toggles the video bandwidth between AUTO and MNL.
AUTO:	Automatically sets an optimum video bandwidth according to the resolution bandwidth setting.
MNL:	Allows you to set the video bandwidth manually.
<i>Wide RBW ON/OFF</i>	Toggles the wide band RBW setting function on or off. The setting is effective only in the zero span mode.
ON:	Sets RBW 10 MHz and VBW OFF.
OFF:	Turns the wide band RBW setting function off to restore RBW and VBW to the original settings.
<i>Auto All</i>	Automatically sets the resolution bandwidth, the video bandwidth and the sweep time according to the span settings.

3.3.3 CAL Key (Calibration)

This section describes the menu displayed when the **SHIFT** key and the **7 (CAL)** key are pressed.

Cal All Executes all calibration routines.

CAUTION: *Do not perform a PRESET operation (SHIFT, PRESET) while calibrating the spectrum analyzer because this will erase all calibration data.*

Total Gain Measures the absolute error using a resolution bandwidth of 300 kHz, and the calibration signal output of both -15dBm and 1dB/DIV.

Each Item Changes the display to the Each Item menu.

IF Step Amp Measures the IF Step AMP switching error and calibrates it.

RBW Switch Measures the switching error for the IF Filter resolution bandwidth and calibrates it.

Log Linear Measures the linearity of the ordinate axis at a range of 10 dB/DIV to 1 dB/DIV on the LOG scale and calibrates it.

AMPTD OFS Calibrates the level offset in the LOG scale.

PBW Measures PBW (noise power bandwidth) at a resolution bandwidth range of 1 kHz to 3 MHz and calibrates it. (The resolution bandwidth is 30 Hz or more when the narrow-band RBW option is installed.)

Freq Corr ON/OFF Toggles the frequency correction function on or off.

ON: Frequency characteristics are corrected.

OFF: Turns the frequency correction function off.

Cal Corr ON/OFF Toggles the calibration factor on or off.

ON: The calibration factor is used.

OFF: The calibration factor is not used.

Cal Sig Level Sets the output level of calibration signals.

1/2_more Displays the Cal menu (2/2).

Cal 10MHz Ref Displays the Cal Ref menu.

Coarse Enters the compensation value for the 10 MHz reference coarse adjustment.

3.3.3 CAL Key (Calibration)

<i>Fine</i>	Enters the compensation value for the 10 MHz reference fine adjustment.
<i>Store</i>	Saves the frequency compensation data based on the 10 MHz reference.
<i>Default</i>	Restores the compensation values for the coarse and fine adjustments to the factory defaults.
<i>2/2_more</i>	Displays the Cal menu (1/2).

3.3.4 CONFIG Key (Configuration)

This section describes the Config menu(1/2) displayed when the **CONFIG** key is pressed.

Pressing this key allows you to set a GPIB interface.

GPIB Sets the GPIB address for the analyzer.

RS232 Displays the RS232 dialog box.

RS232						
Baud Rate :	600	1200	2400	4800	9600	19200
Data Length :	7	8				
Stop Bit :	1	2				
Parity Bit :	NONE	ODD	EVEN			
Flow Control :	NONE	XON/XOFF				

Baud Rate Sets the transmission rate to 600, 1200, 2400, 4800, 9600 or 19200 bps.

Data Length Sets the data bit length to 7 or 8 bits.

Stop Bit Sets the stop bit to either 1 or 2.

Parity Bit Sets the parity bit type.

NONE: Does not perform parity checking.

ODD: Sets the parity bit type to odd.

EVEN: Sets the parity bit type to even.

Flow Control Turns the flow control function on.

NONE: No flow control is performed.

XON/XOFF:

Flow control is performed according to the XON or XOFF code sent.

Copy Config Displays the Copy Config menu used to set the destination of screen data output.

Printer Displays the Printer dialog box.

3.3.4 CONFIG Key (Configuration)

Printer			
Copy Mode :	Color	S-Color S	S-Color L
	Gray	Mono S	Mono L
Printer Command :	ESC/P	PCL	ESC/P-R
Menu Print :	ON	OFF	
Paper Feed :	ON	OFF	

Copy Mode

Sets the output mode.

Color: Prints the screen data in size L and the actual screen color.

S-Color S:
Changes the screen data into a simple color image and prints it in size S.

S-Color L:
Changes the screen data into a simple color image and prints it in size L.

Gray: Prints the screen data in size L and in a four-level gray scale.

Mono S: Sets the printer output mode to monochrome for S size.

Mono L: Sets the printer output mode to monochrome for L size. L size is approximately the width of the paper used for the analyzer in landscape orientation. S size is approximately the width of the paper used for the analyzer in portrait orientation.

Printer Command Selects the printer type.

ESC/P: Allows you to use an ESC/P printer.

HP PCL: Allows you to use a HP PCL printer.

ESC/P-R: Allows you to use an ESC/P Raster printer.

NOTE: *Color, S-Color S and S-Color L in the Copy Mode menu are available when HP PCL or ESC/P Raster is selected.*

Menu Print

Sets whether or not the menu labels are printed.

ON: The menu is included in the printout.

OFF: The menu is not included in the printout.

Paper Feed

Sets whether or not a sheet of paper is fed after a hard copy is output. This function can be set when Copy Mode is set to S-Color S or Mono S.

ON: Feeds a sheet of paper after the hard copy is output.

OFF: Does not feed a sheet of paper after the hard copy is output. Multiple screen data can be printed on an A4-size sheet of paper.

File

Displays the File dialog box.

File	
File Format :	<input checked="" type="radio"/> BMP
Copy Mode :	<input type="radio"/> Color <input checked="" type="radio"/> S-Color <input type="radio"/> Gray <input type="radio"/> Mono
Compression :	<input type="checkbox"/> OFF <input checked="" type="checkbox"/> ON
File No. :	<input type="text" value="001"/> Filename: \IMG\ADV001.BMP
Auto Increment :	<input type="checkbox"/> OFF <input checked="" type="checkbox"/> ON

File Format

Sets the file in the BMP (bitmap) format.

Copy Mode

Sets the color depth for the file.

Color: Files are saved in 256 colors.

S-Color: Files are saved in simple color.

Gray: Files are saved in gray scale (4 shades of gray).

Mono: Files are saved in monochrome (black and white).

Compression

Toggles the image compression mode (compliant with RLE format under MS-Windows) on or off.

This mode is enabled to be set when Copy mode is set to Color, S-Color or Gray.

ON: Compresses the image when saved.

OFF: Images are saved without image compression.

File No.

Allows you to change the image file number used in the file name.

Auto Increment

Toggles the Auto Increment for file number on or off.

ON: The file number is incremented every time an image data is saved.

OFF: The file number specified by the file number field is used.

3.3.4 CONFIG Key (Configuration)

Copy Device PRT/FD

Switches between PRT (printer) and FD (floppy disk) for the Copy Device.

PRT: Sets the destination to printer.

FD: Selects floppy disk.

Change Title

Changes the title previously entered.

10M Ref INT/EXT

Switches between internal signals (INT) and external signals (EXT) for 10 MHz reference frequency output.

INT: Internal signals are used.

EXT: Use the 10 MHz REF IN terminal as the external input signal source.

CAUTION:

- 1. EXT is automatically displayed when the external signal is detected.*
 - 2. When the external signal is not detected, EXT is automatically changed to INT.*
-

Annotation ON/OFF

Toggles the annotation (comment characters) display function on or off.

ON: Displays annotations.

OFF: Erases annotations.

Points 1001/501

Switches between 1001 and 501 for horizontal axis trace points.

1001: Sets trace points to 1001 points.

501: Sets trace points to 501 points.

1/2_more

Displays the Config menu (2/2).

Format FD

Formats a floppy disk.

Date/Time

Displays the Date/Time dialog box.

Date/Time		
Year :	<input type="text" value="2000"/>	
Month :	<input type="text" value="04"/>	
Day :	<input type="text" value="07"/>	
Hour :	<input type="text" value="16"/>	
Minute :	<input type="text" value="09"/>	
Format :	<input checked="" type="button" value="LONG"/>	<input type="button" value="SHORT"/>
	<input type="button" value="OFF"/>	
Order :	<input checked="" type="button" value="YMD"/>	<input type="button" value="MDY"/>
	<input type="button" value="DMY"/>	

Year

Allows you to set the year.

Month

Allows you to set the month.

Day

Allows you to set the day.

Hour

Allows you to set the hour.

Minute

Allows you to set the minutes.

Format

Selects the date indication mode.

LONG: Displays the date and time.

SHORT: Displays the date only.

OFF: Does not display the date and time.

Order

Selects the format of the date indication.

Year/Month/Day:

Displays in the order of a day of the week, year, month and day.

Month/Day/Year:

Displays in the order of a day of the week, month, day and year.

Day/Month/Year:

Displays in the order of a day of the week, day, month and year.

Color Pattern

Displays the Color menu used to set display condition.

Color 1

Sets the color display (256 colors) to pattern 1.

Color 2

Sets the color display (256 colors) to pattern 2.

3.3.4 CONFIG Key (Configuration)

<i>Gray</i>	Sets the screen display to gray scale (16 levels).
<i>B&W</i>	Sets the screen display to monochrome display.
<i>Inverse</i>	Inverts the background colors of the screen display between black and white. This is effective for the Gray or B&W setting only.
<i>Revision</i>	Displays the software version number and all options installed in your spectrum analyzer.
<i>Default Config</i>	Resets all spectrum analyzer settings to the factory defaults (refer to Table 3-5).
<i>2/2_more</i>	Displays the Config menu (1/2).

3.3.5 COPY Key (Hard Copy)

Sends the screen data to the destination selected by the *Copy Config* item in the Config (1) menu. (Note there is no menu associated with this panel key.)

*To abort printing:

Pressing **SHIFT**, **COPY** and *Abort* aborts the printing currently taking place.

3.3.6 COUNTER Key (Frequency Counter)

3.3.6 COUNTER Key (Frequency Counter)

Activates the Frequency counter mode and displays the associated menu. The current measurement frequency is also displayed.

<i>Res 1kHz</i>	Sets the frequency counter resolution to 1kHz.
<i>Res 100Hz</i>	Sets the frequency counter resolution to 100 Hz.
<i>Res 10Hz</i>	Sets the frequency counter resolution to 10 Hz.
<i>Res 1Hz</i>	Sets the frequency counter resolution to 1 Hz.
<i>Counter OFF</i>	Turns the frequency counter mode off.

3.3.7 DISPLAY Key (Line and Window)

This section describes the menu displayed when the **DISPLAY** key is pressed.

<i>Disp Line ON/OFF</i>	Toggles the display line indication on or off. The display line is used as a base line when comparing trace levels.
ON:	Turns the display line on. The display line position can be adjusted under this setting.
OFF:	Turns the display line off.
<i>Ref Line ON/OFF</i>	Toggles the reference line indication on or off. The reference line is used as a base line to which the level value is relative.
ON:	Displays the reference line. The reference line position can be adjusted under this setting.
OFF:	Turns the reference line off.
<i>Measuring Window</i>	Displays the Window menu.
<i>Window ON/OFF</i>	Turns the measuring window display on or off.
ON:	Displays the measuring window.
OFF:	Erases the measuring window.
<i>Window Position</i>	Allows you to set the measuring window position.
<i>Window Width</i>	Allows you to set the measuring window width.
<i>Window Sweep ON/OFF</i>	Turns the window sweep function on or off.
ON:	Sweeps the range specified by the measuring window.
OFF:	Sweeps the range specified by the span.
<i>Marker Couple ON/OFF</i>	Turns the marker couple function on or off.
ON:	Marker search is limited to the inside of the measuring window.
OFF:	Turns the marker couple function off. The whole screen is searched.
<i>Multi Screen</i>	Displays the Multi Scrn menu.

3.3.7 DISPLAY Key (Line and Window)

Zoom	Displays the Zoom menu and two windows. The window indicating the zoom position is displayed in the upper screen, while the zoom is displayed in the lower screen. The horizontal axis represents frequency (or time) in both the upper and lower screens.
<i>Zoom Position</i>	Allows you to set the zoom position.
<i>Zoom Width</i>	Allows you to set the zoom width.
<i>Screen A/B</i>	Toggles the active screen between A (upper screen) and B (lower screen).
<i>Screen Reset</i>	Resets the screen display to one screen (upper screen) and returns to the Multi Scrn menu.
F/T	Displays the Zoom menu and two windows. The window indicating the zoom position is displayed in the upper screen. The horizontal axis in the upper screen represents the frequency. The horizontal axis in the lower screen represents the time (zero span) in the zoom position.
<i>Zoom Position</i>	Allows you to set the zoom position.
<i>Screen A/B</i>	Toggles the active screen between A (upper screen) and B (lower screen).
<i>Screen Reset</i>	Resets the screen display to one screen (upper screen) and returns to the Multi Scrn menu.
T/T	Displays two windows, and the horizontal axis in both the upper and lower screens is displayed in the time domain (zero span at the center frequency). Different frequencies can be set for the upper and lower screens.
<i>Screen A/B</i>	Toggles the active screen between A (upper screen) and B (lower screen).
<i>Screen Reset</i>	Resets the screen display to one screen (upper screen).

3.3.8 EMC Key (EMC Measurement)

This section describes the menu displayed when the **SHIFT** key and the 1(EMC) key are pressed.

<i>Detector Mode</i>	Displays the Detector menu.
<i>QP</i>	Displays the QP menu and detects the quasi peak value.
<i>RBW Auto</i>	Automatically sets the resolution bandwidth. (NOTE)
<i>RBW 200Hz</i>	Sets the resolution bandwidth to 200 Hz (available for OPT27 only). (NOTE)
<i>RBW 9kHz</i>	Sets the resolution bandwidth to 9 kHz. (NOTE)
<i>RBW 120kHz</i>	Sets the resolution bandwidth to 120 kHz. (NOTE)
<hr/>	
<i>NOTE:</i>	<p><i>Set the appropriate sweep time for the specified RBW and frequency span.</i></p> <p><i>Set the sweep time to 1 sec for 200 Hz of frequency span when the RBW is 200 Hz.</i></p> <p><i>Set the sweep time to 1 sec for 10 kHz of frequency span when the RBW is 9 kHz.</i></p> <p><i>Set the sweep time to 1 sec for 100 kHz of frequency span when the RBW is 120 kHz.</i></p>
<hr/>	
<i>Peak</i>	Displays the Peak menu and detects the peak value.
<i>RBW Auto</i>	Automatically sets the resolution bandwidth.
<i>RBW 200Hz</i>	Sets the resolution bandwidth to 200 Hz (available for OPT27 only).
<i>RBW 9kHz</i>	Sets the resolution bandwidth to 9 kHz.
<i>RBW 120kHz</i>	Sets the resolution bandwidth to 120 kHz.
<i>RBW 1MHz</i>	Sets the resolution bandwidth to 1 MHz.
<i>Normal</i>	Switches to the current detector as set at <i>Detector</i> (the Trc Det menu) in the TRACE .
<i>Field</i>	Displays the Antenna menu. From here, select the antenna factor you wish to correct for (5D2W cable, 10 m including the cable loss).
<i>TR1722</i>	Corrects for half-wave dipole antennas (TR1722).
<i>UHALP9107</i>	Corrects for log-periodic antennas (UHALP9107).

3.3.8 EMC Key (EMC Measurement)

<i>BBA9106</i>	Corrects for biconical antennas (BBA9106).
<i>EMCO3142</i>	Corrects for bilog antennas (EMCO3142).
<i>User ANT Corr</i>	Opens the user-definable correction table, and displays the correction data list in the User Ant Corr menu.
<i>Insert Line</i>	Inserts a line in the cursor position.
<i>Delete Line</i>	Deletes the line at the cursor position.
<i>Sort</i>	Sorts the frequency data in the table in the ascending order.
<i>Table Init</i>	Deletes the data from the table.
<i>Corr Mode ANT/LVL</i>	Toggles between the antenna factor (for the defined correction data) and the level correction data settings.
	ANT: Sets the antenna factor, and automatically sets the unit used for the vertical axis to dB μ V/m.
	LVL: Sets the level correction data, and sets the unit for the vertical axis to the level you have previously chosen.
	Any other antenna factors than those chosen by the user are considered invalid, so the displayed unit will automatically be dB μ V/m.
<i>Corr OFF</i>	No longer uses the correction data.
<i>Sound</i>	Displays the Sound menu, and demodulates the sound at the marker.
<i>Sound AM/FM</i>	Toggles between AM and FM demodulation.
<i>Volume</i>	Allows you to set the demodulated sound volume. The volume can be set from a range of 1 to 12.
<i>Marker Pause Time</i>	Allows you to set the duration of the pause used during demodulation.
<i>Squelch ON/OFF</i>	Toggles the squelch function on or off.
	ON: Displays the squelch marker which indicates that the sound carrier level below this level is not demodulated. The squelch level can also be changed.
	OFF: Removes the squelch marker, and turns off the squelch function.

Sound OFF

Turns off the sound demodulation function and displays the EMC menu.

3.3.9 **FREQ Key (Frequency)****3.3.9 FREQ Key (Frequency)**

Pressing this key displays the FREQ menu and allows you to set the center frequency (or the start frequency when the start and stop frequencies are displayed). In addition, it displays both the current center frequency and frequency span (or both the start and stop frequencies) in the area below the bottom scale line.

<i>Center</i>	Allows you to set the center frequency, and displays the center frequency and frequency span in the annotation area below the bottom scale line.
<i>Start</i>	Allows you to set the start frequency (the frequency furthest to the left on the frequency axis), and displays the start and stop frequencies in the annotation area below the bottom scale line.
<i>Stop</i>	Allows you to set the stop frequency (the frequency furthest to the right on the frequency axis), and displays the start and stop frequencies in the annotation area below the bottom scale line.
<i>CF Step AUTO/MNL</i>	Toggles the step size function between AUTO and MNL. This function is used to change a center frequency using the step keys. AUTO: Automatically sets the step size to 1/10 of the frequency span. MNL: Allows you to set the step size manually.
<i>Freq Offset ON/OFF</i>	Turns the frequency offset function on or off. ON: Sets an offset value and changes only the frequency display by the offset value. (Displayed frequency value = Set value + Offset value) OFF: Turns the offset function off.
<i>Channel Setting</i>	Displays the CH Setting menu. Allows you to set the channel frequency from the channel table after the input mode has been changed. The types of data entered by the <i>Center</i> , <i>Start</i> and <i>Stop</i> keys vary depending on the input mode.
<i>Frequency Input</i>	Displays the Frequency Input dialog box.
<i>Input Type</i>	Input Type can be switched to the center frequency, starting frequency or stop frequency. Frequency: Sets the input type to normal frequency mode. CH Type 1: Sets the input type to CH Type 1 mode which allows you to set the center frequency using a channel number (with the FREQ key) or a frequency (with the <i>Center</i> key).

The *Start* and *Stop* keys are used to set frequencies.

To set sequential channels which all have the same channel bandwidth, use the channel numbers in the appropriate table created from the expression in the *CH Type 1 Edit* function.

CH Type 2:

Sets the input type to CH Type 2 mode which allows you to set the **FREQ**, *Center*, *Start* and *Stop* keys using a channel number.

To set sequential channels which have unique channel bandwidths, use the channel numbers in the appropriate table created from the frequency list in the *CH Type 2 Edit* function.

<i>Start CH Shift</i>	Used to enter the shift amount of the start channel's start frequency when <i>Input Type</i> is CH Type 2. Sets the start frequency of the top channel in the <i>CH Type 2 Edit</i> table so that the start frequency is increased by the shift amount.
<i>Stop CH Shift</i>	Used to enter the shift amount of the stop channel's stop frequency when <i>Input Type</i> is CH Type 2. Set the stop frequency of the last channel in the <i>CH Type 2 Edit</i> table so that the stop frequency is decreased by the shift amount.
<i>CH Type 1 Edit</i>	Displays the CH Type 1 Setting editor.
<i>Table 1 to 3</i>	Toggles the table mode (for Table 1 thru 3) between ENABLE and DISABLE. ENABLE: Displays the corresponding table. DISABLE: Does not display the corresponding table.
<i>Channel</i>	Allows you to edit the channel range. Enter the start and stop channel numbers so that they satisfy the following expression: $(\text{Start channel number}) \leq N \leq (\text{Stop channel number})$.
<i>Carrier</i>	Allows you to edit the carrier frequency range. Enter the value calculated from the following formula: $(\text{Channel spacing}) \times (N + \text{Channel offset}) + (\text{Start frequency})$
<i>CH Type 2 Edit</i>	Displays the CH2 Edit menu and the CH Type 2 Setting editor. This item is used to enter the channel number, carrier frequency, channel start frequency and channel stop frequency. A total of 99 channels can be used.
<i>Insert Line</i>	Inserts a line in the cursor position.

3.3.9 FREQ Key (Frequency)

<i>Delete Line</i>	Deletes the line at the cursor position.
<i>Sort</i>	The carrier frequencies in the table are sorted in ascending order.
<i>Table Init</i>	Deletes data from the table.
<i>1/2_more</i>	Displays the Freq menu (2/2).
<i>Presel</i>	Displays the Presel menu (For the R3162/72/82).
<i>Auto Tune</i>	Automatically tunes the preselector according to the peak frequency.

NOTE: To terminate the tuning, press any keys other than the **COPY, LOCAL, SINGLE and REPEAT** keys.

<i>Manual Tune</i>	Allows you to tune the preselector manually.
<i>Mixer INT/EXT</i>	Switches between the Internal and External mixers (Compatible with OPT16 thru OPT19 only).
	INT: Uses the internal mixer.
	EXT: Uses the external mixer.
<i>Ext Mixer Config</i>	Displays the Mix Config menu (Compatible with OPT16 thru OPT19 only).
<i>Band Select</i>	Used to select the frequency band of the external mixer. The relationships among frequency bands, frequency ranges and harmonic orders are as follows.

Frequency band	Frequency range [GHz]	Harmonic order [N]
1	17.0 to 26.5	4
2	22.0 to 33.0	5
3	26.5 to 40.0	6
4	33.0 to 50.0	8
5	40.0 to 60.0	8
6	50.0 to 75.0	10
7	70.0 to 80.0	12
8	60.0 to 90.0	12
9	75.0 to 110.0	16
10	90.0 to 140.0	20
11	110.0 to 170.0	24
12	140.0 to 220.0	30
13	170.0 to 260.0	36
14	220.0 to 325.0	44

<i>Band Lock ON/OFF</i>	Toggles the frequency band lock function on or off.
	ON: Locks the frequency band to the one selected for the external mixer.
	OFF: Automatically switches the frequency band according to the start and stop frequencies.
<i>Average Loss ON/OFF</i>	Toggles the correction function (used for the external mixer's intrinsic average conversion loss) on or off.
	ON: Corrects for the conversion loss using an average conversion loss value.
	OFF: Turns the correction function off.
<i>Loss:Freq ON/OFF</i>	Toggles the correction function on or off.
	ON: Corrects for conversion loss using the frequency vs. loss table.
	OFF: Turns the correction function off.
<i>Loss:Freq Edit</i>	Displays the Loss:Freq menu.
<i>Insert Line</i>	A line with the same values is inserted in the line where the cursor is located.
<i>Delete Line</i>	The line where the cursor is located is deleted.
<i>Sort</i>	The data previously entered is sorted by frequency.
<i>Table Init</i>	Deletes all data from the table.
<i>Signal Ident ON/OFF</i>	Toggles the Signal Identification function on or off (Compatible with OPT16 thru OPT19 only).
	ON: More than one spectrum is displayed for one input signal when an external mixer is used. From among these spectrums, the true signal is identified.
	OFF: Turns off the signal identification function.
<i>Image Suppress ON/OFF</i>	Toggles the Software Image Suppression function on or off (Compatible with OPT16 thru OPT19 only).
	ON: Used to identify actual signals as in the Signal Identification function. Eliminates unnecessary image signals using a software function so that an input signal can be easily observed.

3.3.9 FREQ Key (Frequency)

2/2_more

OFF: Turns off the Software Image Suppression function.

Returns to the Frequency (1) menu.

3.3.10 Hold Mode

Pressing the **SHIFT** key for several seconds until the word “HOLD” appears on the screen activates the Hold mode. This mode disables all panel and soft key input.

Pressing the **SHIFT** until “HOLD” is removed from the screen deactivates Hold mode.

3.3.11 LEVEL Key (Frequency Level)

3.3.11 LEVEL Key (Frequency Level)

This section describes the menu (1/2) displayed when the **LEVEL** key is pressed.

<i>Ref Level</i>	Allows you to set the reference level.
<i>ATT AUTO/MNL</i>	Toggles the input attenuator between AUTO and MNL.
	AUTO: Automatically sets an optimum input attenuator in accordance with the reference level setting.
	MNL: Allows you to set an input attenuator within a range of 0 to 50 dB (in 5 dB step) for the R3132/N; within a range of 0 to 75 dB (in 5 dB step) for the R3162. Setting the attenuation to 0 dB is possible only by using the numeric keys.

NOTE: When Hi Sens ON/OFF is turned on, the input signal range is between 0 and 30 dB.

<i>dB/div</i>	Displays the dB/div menu, which includes amplitude scales (for the vertical axis) and is used to display data in logarithmic scale.
<i>10dB/div</i>	Sets the amplitude scale (vertical axis) to 10 dB/div.
<i>5dB/div</i>	Sets the amplitude scale (vertical axis) to 5 dB/div.
<i>2dB/div</i>	Sets the amplitude scale (vertical axis) to 2 dB/div.
<i>1dB/div</i>	Sets the amplitude scale (vertical axis) to 1 dB/div.
<i>Linear</i>	Displays the reference level data between 0 V and the REF level on a linear scale (in volts).
<i>Units</i>	Displays the Units menu which sets the units used for the reference level, the display line and the marker level.
<i>dBm</i>	Sets the unit to dBm.
<i>dBmV</i>	Sets the unit to dBmV.
<i>dBμV</i>	Sets the unit to dBμV.
<i>Watts</i>	Sets the unit to W.
<i>Volts</i>	Sets the unit to V.
<i>Hi Sens ON/OFF</i>	Turns the high sensitivity input function on or off.

	ON:	Turns on the built-in pre-amplifier at the gain of 20 dB and over. Since the gain of the pre-amplifier at each frequency is corrected, no gain needs to be considered for level measurement.
	OFF:	Turns the built-in pre-amplifier off.
<i>1/2_more</i>		Displays the Level menu (2/2).
<i>Ref Offset ON/OFF</i>		Toggles the reference level offset function on or off.
	ON:	Allows you to set the offset level in a range of 0 to ± 100.0 dB. The relationships between the displayed reference level, the set reference level and the offset are shown below: Reference level (displayed) = Reference level (set) + Offset.
	OFF:	Turns off the offset.
<i>Input 50Ω/75Ω</i>		Sets the impedance input level for the display. The 75 Ω setting is used when a 75 Ω impedance converter (ZT-130NC) is connected to the RF input. The R3132 converts all levels for the 75 Ω system and displays them.
<i>2/2_more</i>		Displays the Level menu (1/2).

3.3.12 LOCAL Key (GPIB Remote Control)

3.3.12 LOCAL Key (GPIB Remote Control)

Turns off GPIB remote control. (Note there is no menu associated with this panel key.)

3.3.13 MEAS Key (Measurement)

This section describes the menu displayed when the **MEAS** key is pressed.

<i>Noise/Hz</i>	Displays the Noise/Hz menu, and allows you to set the frequency width for noise measurement.
<i>dBm/Hz</i>	Sets the vertical axis unit to dBm, and sets the marker readout signal level unit to dBm/Hz. In addition, the detector is automatically set to the sample detection mode.
<i>dBμV/\sqrtHz</i>	Sets the vertical axis unit to dB μ V, and sets the marker readout signal level unit to dB μ V/ \sqrt Hz. In addition, the detector is automatically set to the sample detection mode.
<i>dBc/Hz</i>	Sets the unit of delta marker signal level to dBc/Hz and turns the marker fixed function (delta marker) ON, then sets the detector to the sample detection mode.
<i>Noise/Hz OFF</i>	Turns off the noise measurement mode, and displays the Measure menu.
<i>XdB Down</i>	Displays the XdB Down menu.
<i>XdB Down</i>	Moves the normal marker to an intersection point on the trace x dB down from the present location according to the <i>MKR Read DLT/LFT/RHT</i> setting.
<i>XdB Left</i>	Moves the normal marker to the left to an intersection point on the trace x dB down from the present location.
<i>XdB Right</i>	Moves the normal marker to the right to an intersection point on the trace x dB down from the present location.
<i>MKR Read DLT/LFT/RHT</i>	Selects the marker display under the x dB down function to either DLT, LFT or RHT. <ul style="list-style-type: none"> DLT: The delta marker is displayed on the left; and the normal marker, on the right. LFT: The normal marker is displayed on the left. RHT: The normal marker is displayed on the right.
<i>Cont Down ON/OFF</i>	Toggles the count down function on or off. <ul style="list-style-type: none"> ON: Sets the x dB down function to repeat continuously. Establishes the trace peak point for each sweep which is used as the reference point of the marker down. OFF: Turns off the count down function.

3.3.13 MEAS Key (Measurement)

3rd Order Meas

Displays the delta marker on the peak of the fundamental wave and the normal marker on the peak of the third order intermodulation distortion.

Use the value displayed when Peak Delta Y is pressed as the peak search condition.

% AM Meas ON/OFF

Toggles the %AM Meas function on or off.

ON: Calculates an AM modulation factor using a peak search, and displays the result as a percentage (%).
Use the value displayed when Peak Delta Y is pressed as the peak search condition.

OFF: Turns off the %AM Meas.

% AM Video ON/OFF

Toggles the %AM Video function on or off.

ON: Displays the AM modulation factor (as percentage) after video signal's AM modulation factor has been calculated using the peak search.

OFF: Turns the %AM Video function off.

FM Meas

Displays the FM Meas menu to measure FM signal frequency deviation. The value of the Peak Delta Y is used to perform the peak search.

If the mode "Mod Freq → SWP T ON/OFF" is set to ON, the sweep time is optimally set using the modulation frequency and the number of displayed trace points.

If the mode "Mod Freq → SWP T ON/OFF" is set to OFF, the sweep time must be set using the expression shown below.

$$\text{SWP} \geq \text{PT} \times 1/\text{Fmod}$$

SWP: Sweep time

PT: Number of displayed trace points

Fmod: Modulation frequency

(Posi mode is automatically set when the FM Meas function is selected. Refer to Posi.)

Mod Freq → SWP T ON/OFF

Toggles the sweep time calculation function (if given a modulation frequency) on or off.

ON: Sets the modulation frequency and then calculates the sweep time.

OFF: Turns the sweep time calculation function off.
The value set by SWP Time AUTO/MNL is used as the sweep time when starting measurements.

<i>Peak Delta Y</i>	Allows you to set the amplitude used for the peak search.
<i>FM Meas OFF</i>	Turns the FM Meas function OFF.
<i>1/2_more</i>	Displays the Measure menu (2/2).
<i>Sound</i>	Displays the Sound menu, and demodulates the sound at the marker.
<i>Sound AM/FM</i>	Toggles between AM and FM demodulation.
<i>Volume</i>	Allows you to set the demodulated sound volume. You can set the sound volume from a range of 1 to 12.
<i>Marker Pause Time</i>	Allows you to set the duration of the pause used during demodulation.
<i>Squelch ON/OFF</i>	Toggles the squelch function on or off. ON: Displays the squelch marker which indicates that the sound carrier level below this level is not demodulated. The squelch level can also be changed. OFF: Removes the squelch marker, and turns off the squelch function.
<i>Sound OFF</i>	Turns off the sound demodulation function.
<i>Phase Noise</i>	Displays the Phase Noise menu. A menu used to measure phase noises and phase jitters is displayed.
<i>C/N Meas</i>	Displays the C/N Meas menu. A variety of settings for the phase noise measurement can be performed. For this measurement, a phase noise is calculated using an offset frequency which is deviated from the carrier frequency or the current center frequency. A maximum offset frequency of 10 points can be measured.
<i>Edit Table</i>	Displays the Edit Table menu, allowing you to set the desired offset frequency.
<i>Insert</i>	Enters the same data in the current cursor position.
<i>Delete</i>	Deletes the data at the current cursor position.
<i>Table Init</i>	Deletes all data from the table.
<i>Sig Track ON/OFF</i>	Toggles the signal track mode on or off.

3.3.13 MEAS Key (Measurement)

ON: The signal track mode is turned on, and measurements are taken by keeping track of the carrier frequency, which results in changes to the center frequency.

OFF: Turns the signal track mode off.

Average Times ON/OFF

Toggles the trace averaging function on or off.

ON: Sets the number of averaging times and traces and averages the phase noise waveform for each offset frequency.

OFF: Turns the trace average function off.

C/N Meas OFF

The phase noise measurement function is turned off, and the screen returns to the Phase Noise menu.

Phase Jitter

Displays the Phase Jitter menu. A variety of parameters used to measure phase jitter can be set. A jitter is calculated by specifying a phase noise integration range based on an offset frequency deviated from the carrier frequency that is the same as the current center frequency.

Start Offset

Sets the lower limit of the phase noise integration range.

Stop Offset

Sets the upper limit of the phase noise integration range.

Sig Track ON/OFF

Toggles the signal track mode on or off.

ON: The signal track mode is turned on, and measurements are taken by keeping track of the carrier frequency, which results in changes to the center frequency.

OFF: Turns the signal track mode off.

Average Times ON/OFF

Toggles the trace averaging function on or off.

ON: Sets the number of averaging times, traces and then averages the phase noise waveform for each offset frequency.

OFF: Turns the trace average function off.

Phase Jitter OFF

The phase noise measurement function is turned off, and the Phase Noise menu is displayed.

IM Meas

Displays the IM Meas menu in two-screen mode. Traces are displayed on the upper screen, and odd-harmonic measurement data is displayed on the lower screen.

Order

Sets the degrees used. The degrees available are 3, 5, 7 and 9.

Limit Setup

Displays the Limit Setup dialog box.

Limit Setup	
3rd Order:	-40.00 dB
5th Order:	-50.00 dB
7th Order:	-55.00 dB
9th Order:	-60.00 dB

3rd Order

Sets the limit value for a third-order harmonic signal.

5th Order

Sets the limit value for a fifth-order harmonic signal.

7th Order

Sets the limit value for a seventh-order harmonic signal.

9th Order

Sets the limit value for a ninth-order harmonic signal.

Pass/Fail Judgement ON/OFF Toggles the Pass/Fail Judgement function on or off. This function compares a measured value with the value set in the Limit Setup dialog box.

ON: Performs a Pass/Fail judgement. The result is Fail if the measurement value is greater than the limit value.

OFF: Does not perform a Pass/Fail judgement.

Average Times ON/OFF

Toggles the trace averaging function on or off.

ON: Sets the number of averaging times.

OFF: Turns the trace average function off.

Hi Sens (IM Meas) ON/OFF

Toggles the Hi Sens measurement mode on or off. This function is used to increase measurement sensibility.

ON: Decreases the reference level by 20 dB before a harmonic signal is measured.

OFF: A harmonic signal is measured within a single screen.

IM Meas OFF

Turns off the odd harmonic measurement function, and returns to the Measure menu (2/2) display.

2/2_more

Displays the Measure menu (1/2).

3.3.14 MKR Key (Marker)

3.3.14 MKR Key (Marker)

This key displays the Marker menu (1/2) and allows you to set a normal marker.

<i>Normal</i>	Displays the normal marker so that you can use it. The frequency and the level at the marker are displayed in the marker area.
<i>Delta</i>	Allows you to set the delta marker, and displays the delta marker in the same position as that of the normal marker. The frequency and the level values of this marker are relative to those of the normal marker.
<i>Peak Menu</i>	Displays the Peak menu (1/2), and allows you to quickly move the normal marker to any point on the trace.
<i>Next Peak</i>	Moves the present marker to the next highest peak within the search range.
<i>Next Peak Left</i>	Moves the present marker to the next lower frequency peak on the left side of the current marker.
<i>Next Peak Right</i>	Moves the present marker to the next higher frequency peak on the right side of the current marker.
<i>Next Peak Max-Min</i>	Displays the normal marker on the maximum peak, and the delta marker on the minimum peak within the search range.
<i>Min Peak</i>	Moves the delta marker to the minimum peak within the search range.
<i>Cont Peak ON/OFF</i>	Toggles the continuous peak search function on or off. ON: Displays the frequency and the level of the marker after moving the marker to the maximum peak in each sweep. OFF: Turns off the continuous peak search function.
<i>1/2_more</i>	Displays the Peak menu (2/2).
<i>Peak Delta Y</i>	Allows you to set the amplitude settings used for the next peak search. When the Signal Track, %AM Meas, 3rd Order Meas and FM Meas functions are enabled, they are used as amplitude conditions when searching for a signal peak.
<i>Search ALL/UP/LOW</i>	Selects the next peak search range with respect to the threshold value of the display line. All: Removes the display line after repeating the next peak search for all peaks.

	UP:	Performs the next peak search for all the peaks above the display line. The display line can be adjusted from this setting.
	LOW:	Performs the next peak search for all the peaks under the display line. The display line can be adjusted from this setting.
<i>2/2_more</i>		Returns to the Peak menu (1/2).
<i>Sig Track ON/OFF</i>		Toggles the signal track function on or off.
	ON:	Sets the marker frequency to the center frequency for each sweep, after performing the peak search for the same peak. Use the value displayed when Peak Delta Y is pressed as the peak search condition.
	OFF:	Turns off the signal track function.
<i>MKR Trace A/B</i>		Selects one of the two traces so that the marker is available when traces A and B are displayed simultaneously.
<i>Marker OFF</i>		Turns off all marker functions.
<i>1/2_more</i>		Displays the Marker menu (2/2).
<i>Fixed MKR ON/OFF</i>		Toggles the Fixed Marker function on or off.
	ON:	Stores the frequency and level of the displayed delta marker and fixes the marker at the current physical position on the screen.
	OFF:	Turns off the Fixed Marker function.
<i>MKR Step AUTO/MNL</i>		Toggles the step size function on or off. This function allows you to control the movement of the marker using the step key.
	AUTO:	Automatically sets the step size to 1/10 of the span.
	MNL:	Allows you to manually set the step size to any value.
<i>Multi Marker</i>		Displays the Multi MKR menu.
<i>Multi MKR Setup</i>		Displays the MKR Setup menu.
<i>Marker No.</i>		Allows you to set the multi-marker number and displays the value you entered.
<i>Marker ON</i>		Displays the multi-marker specified by the number. The frequency and level of the marker are displayed in the marker area.

3.3.14 MKR Key (Marker)

<i>Marker OFF</i>	Removes the multi-marker specified by the number.
<i>Active Marker</i>	Turns on or off the multi-marker displayed on the screen.
<i>Reset Marker</i>	Removes all multi-markers except multi-marker No.1.
<i>MKR List ON/OFF</i>	Toggles the multi-marker list display function on or off. ON: Displays a list of the current multi-marker numbers, frequencies and levels in ascending order. OFF: Removes the list of multi-markers.
<i>Peak List Level</i>	Lists the levels and frequencies in descending order of the peak levels.
<i>Peak List Freq</i>	Lists the levels and frequencies in descending order of the peak level frequencies.
<i>Multi MKR OFF</i>	Removes all multi-markers from the display.
<i>2/2_more</i>	Returns to the Marker menu (1/2).

3.3.15 MKR → Key (Marker →)

This section describes the menu displayed when the **MKR →** key is pressed. This menu allows you to use the active marker data (such as frequency and level) as the data for some other function. Item(s) in the MKR → menu (1/2) may be different depending on the marker you use (either normal or delta marker).

<i>MKR → CF</i>	Sets the active marker frequency as the center frequency.
<i>MKR → Ref</i>	Sets the active marker level as the reference level.
<i>Peak → CF</i>	Moves the marker to the maximum peak within the search range, and sets the marker frequency as the center frequency.
<i>Peak → Ref</i>	Moves the marker to the maximum peak within the search range, and sets the marker level as the reference level.
<i>ΔMKR → Span</i>	Sets the frequency difference between the delta and normal marker as the frequency span.
<i>1/2_more</i>	Displays the Mkr → menu (2/2).
<i>MKR → CF Step</i>	Sets the marker frequency as the center frequency for the step size.
<i>ΔMKR → CF Step</i>	Sets the frequency difference between the delta and normal marker as the step size for the center frequency.
<i>MKR → MKR Step</i>	Sets the marker frequency as the step size of the marker.
<i>ΔMKR → MKR Step</i>	Sets the frequency difference between the delta and normal marker as the step size of the marker.
<i>ΔMKR → CF</i>	Sets the frequency difference between the delta and normal marker as the center frequency.
<i>2/2_more</i>	Returns to the Mkr → menu (1/2).

3.3.16 PAS/FAIL Key (Pass/Fail Judgment)

3.3.16 PAS/FAIL Key (Pass/Fail Judgment)

Pressing the **PAS/FAIL** key displays the Pass/Fail menu.

<i>Pass/Fail ON/OFF</i>	Turns the Pass/Fail judgement function, according to the limit lines, on or off.
	ON: A Pass/Fail judgement is made based on the set limit line.
	OFF: Turns the Pass/Fail judgement function off.
<i>Line1 ON/OFF</i>	Turns limit line 1 on or off.
	ON: Displays limit line 1 and the judgement result (PASS or FAIL).
	OFF: Erases limit line 1 and the judgement result.
<i>Line2 ON/OFF</i>	Turns limit line 2 on or off.
	ON: Displays limit line 2 and the judgement result (PASS or FAIL).
	OFF: Displays limit line 2 and the judgement result.
<i>X ABS/LFT/CTR</i>	Sets the attribute of horizontal axis (frequency or time) data of the limit line.
	ABS: Sets the horizontal axis position using the limit line that is set under Limit Line Edit as an absolute value. The horizontal axis position of the limit line moves as the frequency span or the center frequency setting changes.
	LFT: Sets the horizontal axis position using the limit line that is set under Limit Line Edit as a relative value. The horizontal axis position of the limit line is fixed at the position based on the left end without being influenced by changes in frequency span or center frequency.
	CTR: Sets the horizontal axis position using the center of the horizontal axis as a relative value.
<i>Y ABS/TOP/BOT (Y ABS/CTR)</i>	Sets the attribute of vertical axis (level) data of the limit line.
	ABS: Sets the vertical axis position using the limit line that is set under Limit Line Edit as an absolute value. The vertical axis position of the limit line moves as the level setting changes.

TOP: Sets the vertical axis position using the limit line that is set under Limit Line Edit as a relative value. The vertical axis position of the limit line is fixed in the position based on the top without being influenced by changes in level setting.

BOT: Sets the horizontal axis position using the bottom of the vertical axis as a relative value.

Sets the limit line property (in frequencies) along the vertical axis (if OPT73, FM Demodulation function, is turned on).

ABS: The position along the vertical axis is determined from the absolute value of a limit line set by the Limit Line Edit.
The vertical position of the limit line varies according to the change in the center frequency used.

CTR: The position along the vertical axis is determined relative to the limit line value set by the Limit Line Edit.
The vertical position of the limit line is fixed at its center. Note that the center frequency does not affect the vertical position of the limit line.

Shift X/Y

Switches the offset direction for the limit line between X and Y.

X: Sets an offset value for the horizontal axis direction of the limit line.

Y: Sets an offset value for the vertical axis direction of the limit line.

Limit Line Edit

Displays the Edit Menu.

Limit Line 1/2

Selects the limit line to edit on the Edit screen.

Insert Line

Inserts a line in the cursor position.

Delete Line

Deletes the line at the cursor position.

Sort

Sorts the input data according to the frequencies.

Table Init

Deletes all the data in the limit line setting table.

Copy Table 1 to 2

Copies the data created on limit line 1 to limit line 2.

Copy Table 2 to 1

Copies the data created on limit line 2 to limit line 1.

3.3.17 PK SRCH Key (Peak Search)

3.3.17 PK SRCH Key (Peak Search)

Pressing this key displays the frequency and level of the marker after moving the marker to the maximum level of the trace within the search range. (Note there is no menu associated with this panel key.)

3.3.18 POWER MEASURE Key (Power Measurement)

This section describes the Power menu displayed when the **POWER MEASURE** key is pressed.

Channel Power

Activates the measuring window, and displays the CH Power menu.

The channel power is calculated using the formula shown below.

$$P_{CH} = 10 \log \left[\sum_{n=X1}^{X2} \left(10^{\frac{P(n)}{10}} \right) \times \frac{1}{RBW} \times \frac{SPAN}{(X2 - X1 + 1)} \right]$$

P_{CH}: Channel power

P(n): Data (dBm) for each trace point

SPAN: Current span value

PBW: Noise power bandwidth

X1: Data position of start frequency on the x-axis.

X2: Data position of stop frequency on the x-axis.

Window Position

Allows you to set the center of the measuring window (channel bandwidth).

Window Width

Allows you to set the width of the measuring window (channel bandwidth).

Average Times

Allows you to set the number of times the sweep is averaged.

Parameter Setup

Displays the Prmtr Setup menu.

Default

Sets the following settings to default values: the frequency span, resolution bandwidth, video bandwidth, sweep time, detector, trace mode, channel band position and channel bandwidth. When **Default** is enabled, the defaults are automatically set when the channel power is measured.

Manual

Disables the **Default** function. As a result, the above settings must be set manually. The currently set values are used when channel power is measured.

Define → Default

The currently set values are the new defaults.

CH Power OFF

Removes the window and cancels channel power measurements.

Total Power

Measures the total power in the object range (the entire measurement span or window) and displays it.

The total power is calculated using the formula shown below.

The number of trace points on the horizontal axis is set to 1001.

$$P_T = 10 \log \left[\sum_{n=X1}^{X2} \left(10^{\frac{P(n)}{10}} \right) \times \frac{1}{PBW} \times \frac{SPAN}{1001} \right]$$

P_T: Total power to be calculated.

P(n): Data (dBm) for each trace point.

SPAN: Current span value

3.3.18 POWER MEASURE Key (Power Measurement)

PBW: Noise power bandwidth

X1: 1

X2: 1001

Average Power

Measures the power averaged over the object range (the entire measurement span or window) and displays it.

Allows you to set the averaging count used to calculate the average power.

With average power measurements, the resolution bandwidth (RBW) is set to a bandwidth wider than the amplitude variation width (the resolution bandwidth must be at least three times wider than the occupied bandwidth). The average power is calculated using the formula shown below.

The number of trace points on the horizontal axis is set to 1001.

$$P_{AVG} = 10 \log \left[\sum_{n=X1}^{X2} \left(10^{\frac{P(n)}{10}} \right) \times \frac{1}{1001} \right]$$

PAVG: Denotes the average power to be calculated.

P (n): Denotes the data (dBm) for each trace point.

X1: 1

X2: 1001

Power Meas OFF

Turns off the power measurement function.

OBW

Displays the OBW menu.

OBW%

Sets the percentage of occupied power compared to the total power when measuring the occupied bandwidth.

Parameter Setup

Displays the Prmtr Setup menu.

Default

Sets the following settings to default values: the frequency span, resolution bandwidth, video bandwidth, sweep time, detector, trace mode and the OBW%. When **Default** is enabled, the defaults are automatically set when the OBW is measured.

Manual

Disables the **Default** function. As a result, the above settings must be set manually. The currently set values are used when the OBW is measured.

Define → Default The currently set values become the new defaults.

OBW OFF

Turns the OBW measuring function off.

ACP

Displays the ACP menu.

CS/BS Setup

Displays the CS/BS Setup menu, and the editor used to set the channel spacing and specified bandwidth together.

√Nyquist Filter ON/OFFToggles the $\sqrt{\text{Nyquist}}$ filter function on or off.

ON: Turns the Nyquist filter function on.

OFF: Turns the Nyquist filter function off.

Insert Line

Inserts a line in the cursor position.

Delete Line

Deletes the line at the cursor position.

Sort

Sort the CS/BS Setting table by CS.

Table Init

Deletes all data in the table.

BS Window ON/OFF

Toggles the ACP bandpass window display on or off.

ON: Displays the window within the bandpass which is targeted for calculating the ACP.

OFF: Removes the window.

√Nyquist Filter SetupDisplays the $\sqrt{\text{Nyquist}}$ Filter Setup dialog box.

$\sqrt{\text{Nyquist}}$ Filter Setup	
Symbol Rate 1/T:	21.0 kHz
Rolloff Factor:	0.50
$\sqrt{\text{Nyquist}}$ Filter:	<input type="checkbox"/> ON <input checked="" type="checkbox"/> OFF

Symbol Rate 1/T Sets the symbol rate.***Rolloff Factor*** Sets the rolloff factor.***√Nyquist Filter*** Toggles the Nyquist filter function on or off.

ON: Turns the Nyquist filter function on.

OFF: Turns the Nyquist filter function off.

Screen FULL/SEPA/CARRIER

Toggles the screen display between the full and separate screen modes.

FULL: The entire screen is used.
Calculates the ACP based on the total power along the entire band on the screen.

3.3.18 POWER MEASURE Key (Power Measurement)

SEPA: The screen mode is changed to SEPA when a sweep takes place.

CARRIER:
The entire screen is used.
Calculates the ACP based on the power along the band specified by Carrier Band Width.

<i>Parameter Setup</i>	Displays the Prmtr Setup menu.
<i>Default</i>	Sets the following settings to default values: the frequency span, resolution bandwidth, video bandwidth, sweep time, detector, trace mode, CS/BS Setup and \sqrt{N} Nyquist Filter Setup. When <i>Default</i> is enabled, the defaults are automatically set when the ACP is measured.
<i>Manual</i>	Disables the <i>Default</i> function. As a result, the above settings must be set manually. The currently set values are used when the ACP is measured.
<i>Define → Default</i>	The currently set values become the new defaults.
<i>Graph</i>	Displays the Multi MKR menu (used for ACP Graph). Turns the graphic display function on. Displays the leakage power graph as Trace B and puts Delta marker in the center of the screen. The B memory is used to display the ACP graph.
<i>Marker No.</i>	Enter the multi marker number here.
<i>Marker ON</i>	Displays the multi-marker specified at Marker No. in the center of the trace and the frequency and level of the marker in the marker area.
<i>Marker OFF</i>	Removes the multi-marker specified by the number.
<i>Active Marker</i>	Turns on or off the multi-marker displayed on the screen.
<i>Reset Marker</i>	Removes all multi-markers except for multi-marker 1.
<i>Graph OFF</i>	Turns the graphic display function off.
<i>ACP OFF</i>	Turns off the ACP measurement function, and returns to the power menu.
<i>1/2 more</i>	Displays the Power menu (2/2).
<i>Spectrum Mask</i>	Displays the Spect Mask menu. Displays the measurement and judgment results in combination with the pass/fail judgment result using the limit lines for the ACP measurement.

CS/BS Setup Displays the CS/BS Setup menu, and the editor used to set the channel space and channel bandwidth together.

√Nyquist Filter ON/OFF

Toggles the √Nyquist filter function on or off.

ON: Turns the Nyquist filter function on.

OFF: Turns the Nyquist filter function off.

Insert Line Inserts a line in the cursor position.

Delete Line Deletes the line at the cursor position.

Sort Sort the CS/BS Setting table by CS.

Table Init Deletes all data in the table.

BS Window ON/OFF

Toggles the ACP bandpass window display on or off.

ON: Displays the window within the bandpass which is targeted for calculating the ACP.

OFF: Removes the window.

√Nyquist Filter Setup Displays the √Nyquist Filter Setup dialog box.

√Nyquist Filter Setup	
Symbol Rate 1/T:	21.0 kHz
Rolloff Factor:	0.50
√Nyquist Filter:	<input type="checkbox"/> ON <input checked="" type="checkbox"/> OFF

Symbol Rate 1/T Sets the symbol rate.

Rolloff Factor Sets the rolloff factor.

√Nyquist Filter Toggles the Nyquist filter function on or off.

ON: Turns the Nyquist filter function on.

OFF: Turns the Nyquist filter function off.

Results REL/ABS Toggles the unit of the measurement result display.

REL: Displays a relative value (dBc) of the power within the carrier bandwidth (set by CS/BS editor and referred to as the Ref Power) to the ACP power.

3.3.18 POWER MEASURE Key (Power Measurement)

	ABS:	Displays an absolute value using the unit selected from the Units menu under the LEVEL key.
<i>Parameter Setup</i>		Displays the Prmtr Setup menu.
<i>Default</i>		Sets the following settings to default values: the frequency span, resolution bandwidth, video bandwidth, sweep time, detector, trace mode, CS/BS Setup, $\sqrt{}$ Nyquist Filter Setup and Limit Line ON/OFF. When <i>Default</i> is enabled, the defaults are automatically set when the spectrum mask is measured.
<i>Manual</i>		Disables the Default function. As a result, the above settings must be set manually. The currently set values are used when the spectrum mask is measured.
<i>Define → Default</i>		The currently set values become the new defaults.
<i>Spectrum Mask OFF</i>		Turns the spectrum mask function off.
<i>Spurious Freq</i>		The spurious table information is displayed after the Spuri Freq menu has been displayed. (The spurious measurement table is not displayed when there is no table data.) When making spurious measurements while in frequency mode, pass/fail judgment is repeated once for each frequency band after the setup conditions have been selected and a maximum of 10 signal peaks have been searched for each frequency band. When this function is used with Average Power measurement, pass/fail judgments for average powers are performed.
<i>Table No. 1/2/3</i>		Sets Table 1,2 or 3.
	1:	Sets Table 1.
	2:	Sets Table 2.
	3:	Sets Table 3.
<i>Edit Table</i>		Displays the Edit Table menu. The editor used for the selected table number is displayed. You can enter the start and stop frequencies, RBW, sweep time and limit level of the frequency band which is used for pass/fail judgment from this editor. A maximum of 15 frequency bands can be set.
<i>Table No. 1/2/3</i>		Sets Table 1,2 or 3.
	1:	Sets Table 1.
	2:	Sets Table 2.
	3:	Sets Table 3.

<i>Insert</i>	Inserts a column at the cursor position.
<i>Delete</i>	Deletes a column at the cursor position.
<i>Table Init</i>	All data is cleared from the table.
<i>Show Result</i>	Displays the Show Result menu and displays the measurement result in full screen mode. The setup conditions and detailed results are displayed for each frequency band.
<i>Prev Result</i>	Displays the previous frequency band result on the screen.
<i>Next Result</i>	Displays the next frequency band result on the screen.
<i>Sweep Count ON/OFF</i>	Toggles the sweep count (used with the Max Hold mode, Min Hold mode, Average function, Power Average function or Average Power measurement) on or off.
	ON: Allows you to set the sweep count. A pass/fail judgment is performed when the number of sweeps matches the specified sweep count.

NOTE: *If Trace mode is set to Write mode, it is automatically changed as shown below according to the Detector setting as shown below:*

- The Trace mode stays in Write mode if Detector mode is set to Normal.*
- The Trace mode is changed to Max Hold mode if Detector mode is set to Positive.*
- The Trace mode is changed to Min Hold mode if Detector mode is set to Negative.*
- The Trace mode is changed to AVG mode if Detector mode is set to Sample.*

OFF: Turns the sweep count off. The Max Hold mode, Min Hold mode, Average function, Power Average function or Average Power measurement is turned off and a pass/fail judgment is performed for each sweep.

PASS Judge UP/LOW

Toggles the pass area between UP and LOW.

UP: The area above the limit level is set to Pass.

LOW: The area below the limit level is set to Pass.

Spurious Freq OFF

Turns the spurious measurement (in frequency mode) off, and displays the Power menu.

3.3.18 POWER MEASURE Key (Power Measurement)

<i>Spurious Time</i>	The Spuri Time menu and the spurious table information are displayed. (The spurious measurement table is not displayed when there is no table data.) When making spurious measurements while in zero span mode, pass/fail judgment is repeated once for each frequency after the setup conditions have been selected and a maximum of 10 signal peaks have been searched for each frequency. When this function is used with Average Power measurement, pass/fail judgments for average powers are performed.
<i>Table No. 1/2/3</i>	Sets Table 1,2 or 3 1: Sets Table 1. 2: Sets Table 2. 3: Sets Table 3.
<i>Edit Table</i>	Displays the Edit Table menu. The editor of the selected table number is displayed. The frequencies, RBW, sweep time and limit level which are used for pass/fail judgments are entered. A maximum of 15 frequencies can be set.
<i>Table No. 1/2/3</i>	Sets Table 1,2 or 3. 1: Sets Table 1. 2: Sets Table 2. 3: Sets Table 3.
<i>Insert</i>	Inserts the column at the cursor position.
<i>Delete</i>	Deletes the column at the cursor position.
<i>Table Init</i>	All data is cleared from the table.
<i>Show Result</i>	Displays the Show Result menu and displays the measurement result in full screen mode. The setup conditions and detailed results are displayed for each frequency.
<i>Prev Result</i>	Displays the previous frequency result on the screen.
<i>Next Result</i>	Displays the next frequency result on the screen.
<i>Sweep Count ON/OFF</i>	Toggles the sweep count (used with the Max Hold mode, Min Hold mode, Average function, Power Average function or Average Power measurement) on or off.

3.3.18 POWER MEASURE Key (Power Measurement)

ON: Allows you to set the sweep count. A pass/fail judgment is performed when the number of sweeps matches the specified sweep count.

NOTE: *If Trace mode is set to Write mode, it is automatically changed as shown below according to the Detector setting as shown below:*
The Trace mode stays in Write mode if Detector mode is set to Normal.
The Trace mode is changed to Max Hold mode if Detector mode is set to Positive.
The Trace mode is changed to Min Hold mode if Detector mode is set to Negative.
The Average Power measurement is started if Detector mode is set to Sample.

OFF: Turns the sweep count off. The Max Hold mode, Min Hold mode, Average function, Power Average function or Average Power measurement is turned off and a pass/fail judgment is performed for each sweep.

PASS Judge UP/LOW

Toggles the pass area between UP and LOW.

UP: The area above the limit level is set to Pass.

LOW: The area below the limit level is set to Pass.

Spurious Time OFF

Turns the spurious measurement (zero span mode) off, and displays the Power menu.

Single Measure ON/OFF

Sets the sweep conditions used in Single Sweep Mode.

ON: Pressing the **SINGLE** key performs the sweep the specified number of measurement times when the channel power, total power, or average power is measured while the average or power average function is turned on. Note that the average and power average functions require the OBW, ACP (FULL CARRIER), and spectrum mask measurement functions.

OFF: Pressing the **SINGLE** key performs the sweep only once.

2/2_more

Displays the Power menu (1/2).

3.3.19 PRESET Key (Initialization)

3.3.19 PRESET Key (Initialization)

This key is used to reset the spectrum analyzer to its' default settings. This key is accessed by pressing the **SHIFT** key and then the **CONFIG** key. All previous settings are cleared when this is done. (Note there is no menu associated with this panel key.)

3.3.20 RECALL Key (Data Readout)

This section describes the menu displayed when the **RECALL** key is pressed.

Recall Reads out the data from a file selected from the file list.

List ON/OFF Toggles the file list display on or off.

ON: Displays the file list.

OFF: Turns off the file list display.

Device RAM/FD Selects a source for the data.

RAM: Reads out the data from internal memory.

FD: Reads out the data from a floppy disk.

3.3.21 REPEAT Key (Continuous Sweep)

3.3.21 REPEAT Key (Continuous Sweep)

Pressing this key activates the continuous sweep mode.

If this key is pressed during a sweep, the sweep is paused and the sweep lamp is turned off. Pressing the **REPEAT** key again causes the analyzer to wait for another sweep to start and then the sweep lamp turns back on. The sweep will start after a signal is received (which in turn depends on the current trigger mode setting). (Note there is no menu associated with this panel key.)

3.3.22 SAVE Key (Saving Data)

This section describes the menu displayed when the **SHIFT** key and the **RECALL(SAVE)** key are pressed.

Save

Saves the data selected by *Save Item* to the file selected in the file list.

Save Item

Displays the Save Item Setup dialog box.

Save Item Setup			
Setup:	OFF	ON	
Trace:	OFF	ON	
Ant Corr:	OFF	ON	
Norm Corr:	OFF	ON	
Limit Line:	OFF	1	2 1/2
Loss:Freq:	OFF	ON	
Trace Level:	OFF	ON	
Channel:	OFF	ON	
Spurious:	OFF	ON	

Setup

Sets whether or not this function is turned on.

ON: Saves the setup conditions.

OFF: Does not save the setup conditions.

Trace

Sets whether or not this function is turned on.

ON: Saves the trace data.

OFF: Does not save the trace data.

Ant Corr

Sets whether or not this function is turned on.

ON: Saves the correction data.

OFF: Does not save the correction data.

Norm Corr

Sets whether or not this function is turned on. (if OPT74 is included).

ON: Saves the normalized data.

OFF: Does not save the normalized data.

3.3.22 SAVE Key (Saving Data)

<i>Limit Line</i>	Used to control how Limit Line conditions are saved. OFF: Does not save the current values. 1: Saves the current values for Limit Line 1. 2: Saves the current values for Limit Line 2. 1/2: Saves the current values for both Limit Line 1 and 2.
<i>Loss:Freq</i>	Selects whether or not the data in the external mixer frequency-loss table is saved (Only for OPT 16 thru OPT 19). ON: Saves the contents of the external mixer frequency-loss table. OFF: Does not save the contents of the external mixer frequency-loss table.
<i>Trace Level</i>	Sets whether or not this function is turned on. ON: Stores the trace data level (at the present level). OFF: Does not store the trace data level.
<i>Channel</i>	Sets whether or not this function is turned on. ON: Saves the set values used in Channel Type 1 and 2. OFF: Does not save the set values used in Channel Type 1 and 2.
<i>Spurious</i>	Sets whether or not this function is turned on. ON: Saves the table data (Freq/Time). OFF: Does not save the table data (Freq/Time).
<i>Protect</i>	Enables the write protect for the file selected in the file list.
<i>Delete</i>	Removes the selected file from the file list.
<i>Rename</i>	Changes the name of the file selected from the file list.
<i>Change Title</i>	Changes the title on the screen.
<i>Device RAM/FD</i>	Selects the location used to store the data. RAM: Stores the data in internal memory. FD: Stores the data on the floppy disk in the disk drive.

3.3.23 Self Test Key (Self Test)

Pressing **SHIFT** and **0(Self Test)** activates the self test mode, and displays the Self Test menu.

NOTE: *In Self Test mode, all soft menus and panel keys except for those displayed in the soft menu, and the **SHIFT**, **PRESET** and **COPY** keys are disabled.*

Execute Self Test

Five test items are displayed in SELF TEST RESULTS window, and are tested in order.

As each test is completed, PASS or FAIL and Completed are displayed on the screen. After all test items have been completed, The self test ends.

CAUTION: *If **FAIL** appears for any test item, Contact an **ADVANTEST** service representative for repair. The address and telephone are found at the end of this manual.*

Exit

Exits the self test mode.

3.3.24 SINGLE Key (Single Sweep)

3.3.24 SINGLE Key (Single Sweep)

If this key is pressed during a sweep, the sweep is paused and the sweep lamp is turned off. Pressing the **SINGLE** key again causes the analyzer to wait until a sweep starts again (which in turn depends on when it receives a signal). This is controlled by the trigger mode setting. When the channel power measurement, total power measurement, average power measurement, average function, or power average function is performed while “Single Measure ON” is set, the sweep is performed the specified number of times. (Note there is no menu associated with this panel key.)

3.3.25 SPAN Key (Frequency Span)

When pressed, this key displays the Span menu, and allows you to set a frequency span. In addition, the center frequency and frequency span are displayed in the annotation area below the bottom scale line.

Full Span

Sets the frequency span to the full span.

Zero Span

Set a zero span at the center frequency. In zero span mode, the frequency span is 0 Hz, and the spectrum analyzer operates as a tuned receiver. The horizontal axis is the time axis. The receiving bandwidth is determined according to the selected resolution bandwidth.

Peak Zoom

Moves the marker to the maximum peak within the search object range, and sets the marker frequency as the center frequency. In addition, the frequency span is changed to 1/10 of the current frequency span.

Last Span

Resets the frequency span to the previous value.

3.3.26 SWEEP Key (Sweep Time)

3.3.26 SWEEP Key (Sweep Time)

Pressing the **SWEEP** key displays the SWEEP menu.
MNL allows you to specify a sweep time.

<i>SWP Time AUTO/MNL</i>	Toggles the sweep time between AUTO and MNL.
AUTO:	Automatically sets the optimum sweep time according to the span, resolution bandwidth and video bandwidth.
MNL:	Sets the sweep time manually.

NOTE: *When the sweep time is equal to or less than 9 ms, the trace point is set to 501, and the detector is set to the sample detection mode (OPT29).*

Auto All Automatically sets the resolution bandwidth, video bandwidth and sweep time according to the span settings.

Trig Delay Sets the delay time in reference to the trigger point or sets the pre-trigger time.
This is available only when the zero span is selected.

Gated Sweep Displays the Gated Sweep menu and two windows.
The upper screen displays the result of gated sweep, while the lower screen displays a gate signal, the gate position and width.

Gate Source Displays the Gated Source menu.
The trigger conditions for a gate signal in the gated sweep mode can be set.

Ext Sweep is synchronized with external trigger signals.

TV-V Sweep is synchronized with vertical synchronous signals of TV signals.

TV-H Sweep is synchronized with horizontal synchronous signals of TV signals.

Slope (TV Polarity) +/- Switches polarities between + and - for the trigger slope or video modulation of TV signals.

+: Sweep is started at the rise of a trigger.
In the TV trigger mode, sweep is started synchronously with a video modulation signal of + polarity.

-: Sweep is started at the fall of a trigger.
In the TV trigger mode, sweep is started synchronously with a video modulation signal of - polarity.

<i>Gate Position</i>	Sets the position of a gate signal.
<i>Gate Width</i>	Sets the width of a gate signal.
<i>Gated Sweep ON/OFF</i>	Turns the gated sweep mode on or off. ON: Sweep is executed according to the currently set gate conditions (gate position and width). OFF: Turns the gated sweep mode off.
<i>Screen A/B</i>	Toggles the active screen between A and B. A: The upper screen is set to the active state. B: The lower screen is set to the active state.
<i>Gate Setup Quit</i>	The trigger condition setup screen of gate signals is released to return to the Sweep menu.
<i>Gated Sweep ON/OFF</i>	Turns the gated sweep mode on or off. ON: Sweep is executed according to the currently set gate conditions (gate position and width). OFF: Turns the gated sweep mode off.
<i>Ext Gate In ON/OFF</i>	Changes the input signal at the External Trigger connector. ON: Performs a gated sweep using the External Trigger connector signal as the gate signal. Sweeps intermittently when the signal level is greater than approximately 2.5V, and stops sweeping when the signal level is approximately less than 2.5V. OFF: Performs a normal sweep. Uses the input signal at the External Trigger connector as the trigger signal for the Ext Trig mode.

3.3.27 TG Key (Tracking Generator) (OPT74)

3.3.27 TG Key (Tracking Generator) (OPT74)

This section describes the TG menu which is displayed when the tracking generator is turned on.

CAUTION Do not apply voltages that exceed (10 V or power that exceeds + 15 dBm to the TG OUTPUT connector, or you may damage this instrument.

TG Level Allows you to set tracking generator's output level.

Execute Normalize Pressing this key causes the following to occur.

1. Displays the reference line at the midpoint between the maximum and minimum level points which are currently displayed.
The reference line position cannot be changed if it was displayed by previous operation.

2. The current trace is saved in the memory as correction data.

3. The normalization calibration function is activated.

Only trace A is normalized.

CAUTION: Make sure TG OUTPUT is connected to RF INPUT1 before executing the above normalization calibration.

Norm Corr ON/OFF Toggles the normalization function on or off.

ON: Executes a normalization using the correction data saved in the memory.

OFF: Disables the normalization function.

Ref Line Allows you to change the position of the reference line.

Freq Adj Auto For each RBW, the compensation value for tracking generator's output frequency is obtained to prevent the tracking error (a kind of level error caused by the difference in displacement between tracking generator's output frequency and spectrum analyzer's tuning frequency).

CAUTION: Make sure TG OUTPUT is connected to RF INPUT1 before executing the above normalization calibration.

Freq Adj Manual For the current RBW, the compensation value for tracking generator's output frequency is set.

TG OFF Turns the tracking generator off.

3.3.28 TRACE Key (Trace Data)

This section describes Trace A(B) menu (1/2) displayed when the **TRACE** key is pressed.

<i>Write A(B)</i>	Sets the Write mode which updates the data in the A(B) memory for each sweep.
<i>View A(B)</i>	Sets the View mode which holds the data in the A(B) memory.
<i>Blank A(B)</i>	Sets the Blank mode which erases the trace.
<i>Max Hold A(B)</i>	Executes the Max Hold mode which displays the maximum value for each trace sample (when you select the Max Hold mode, the positive mode is automatically selected. Refer to Posi.)
<i>Detector</i>	Displays the Trc Det A(B) menu from which you can set the detection mode used.
<i>Normal</i>	Sets the normal mode which automatically detects positive or negative peak points for each trace point.
<i>Posi</i>	Sets the positive peak mode (when you select the Max Hold mode, the positive mode is automatically selected. Refer to Max Hold A(B).)
<i>Nega</i>	Sets the negative peak mode (when you select the Min Hold mode, the negative mode is automatically selected. Refer to Min Hold A(B).)
<i>Sample</i>	Sets the sample mode.
<i>Trc Menu A/B</i>	Toggles between trace A and trace B.
<i>1/2_more</i>	Displays the Trace A(B) menu (2/2).
<i>AVG A(B)</i>	Displays the AVG A(B) menu.
<i>AVG A(B) ON/OFF</i>	Toggles the averaging function on or off. ON: Turns averaging on. OFF: Turns averaging off.
<i>Average PSE/CONT</i>	Toggles between PSE (pause) and CONT (continue) while the averaging function is being used. PSE: Temporarily pauses averaging and displays the current averaging count. CONT: Resumes averaging from the point at which the pause occurred.

3.3.28 TRACE Key (Trace Data)

Average CONT/SGL

Toggles between CONT (continuation) and SGL (single) modes.

CONT: Continues to average using the current data which is used until the set averaging count is reached.

SGL: Automatically switches to View mode as soon as the desired averaging count has been reached.
When combining this function with OBW, ACP or Spectrum Mask measurement, perform the averaging process the number of times specified by this function before making the OBW or ACP measurement.

Single Measure ON/OFF

Sets the sweep conditions used in Single Sweep Mode.

ON: Pressing the **SINGLE** key performs the sweep the specified number of measurement times when the channel power, total power, or average power is measured while the average or power average function is turned on.
Note that the average and power average functions require the OBW, ACP (FULL, CARRIER), and spectrum mask measurement functions.

OFF: Pressing the **SINGLE** key performs the sweep only once.

Power AVG A(B)

Displays the Power AVG A(B) menu.

Power AVG A(B) ON/OFF

Toggles the power averaging function on or off.
The power averaging function is used to average the power in each frequency using the equation below and display the averaged power.

$$P_{AVG} = 10 \log \left[\frac{1}{n} \times 10^{\left(\frac{P_{in}}{10} \right)} \right]$$

P_{AVG}: Averaged power for each frequency

P_{in}: Power in the nth sweep cycle
(for each of up to 1001 frequency points)

n: Number of sweep cycles

ON: Turns the power averaging function on.

OFF: Turns the power averaging function off.

Average PSE/CONT

Toggles between PSE (pause) and CONT (continue) while the power averaging function is being used.

PSE: Temporarily pauses averaging and displays the current averaging count.

CONT: Resumes averaging from the point at which the pause occurred.

<i>Average CONT/SGL</i>	Toggles between CONT (continuation) and SGL (single) modes.
	CONT: Continues to average using the current data which is used until the set averaging count is reached.
	SGL: Automatically switches to View mode as soon as the desired averaging count has been reached. When combining this function with OBW, ACP or Spectrum Mask measurement, perform the averaging process the number of times specified by this function before making the OBW or ACP measurement.
<i>Single Measure ON/OFF</i>	Sets the sweep conditions used in Single Sweep Mode.
	ON: Pressing the SINGLE key performs the sweep the specified number of measurement times when the channel power, total power, or average power is measured while the average or power average function is turned on. Note that the average and power average functions require the OBW, ACP (FULL, CARRIER), and spectrum mask measurement functions.
	OFF: Pressing the SINGLE key performs the sweep only once.
<i>Min Hold A(B)</i>	Sets the Min Hold mode which is used to display the minimum value for each trace sample (when you select the Min Hold mode, the negative mode is automatically selected. Refer to Nega.)
<i>Store A(B) to B(A)</i>	Stores trace A(B) data as trace B(A).
<i>Math A</i>	Displays the Math A menu.
<i>A-B → A</i>	A: When trace A is in the Write mode, the contents of memory B are subtracted from the sweep result and, then, the result is saved in memory A. When the Display line is active, the Display line value is added to the value obtained previously and saved to A (A - B + DL → A).
<i>B-A → A</i>	A: When trace A is in the Write mode, the sweep result is subtracted from the contents of memory B and, then, the result is saved in memory A. When the Display line is active, the Display line value is added to the value obtained previously and saved to A (B - A + DL → A).
<i>A-DL → A</i>	A: When trace A is in the Write mode, the level of the display line is subtracted from the sweep result and, then, the result is saved in memory A.
<i>Disp Line ON/OFF</i>	Turns the display line, which is used as the reference line for comparing the trace level, on or off.

3.3.28 TRACE Key (Trace Data)

	ON:	The display line is displayed. The display line position can be changed.
	OFF:	The display line is erased.
<i>Trc Menu A/B</i>		Toggles between trace A and trace B.
<i>2/2_more</i>		Returns to the Trace A(B) menu (1/2).

3.3.29 TRIG Key (Trigger)

This section describes the menu displayed when the **TRIG** key is pressed.

<i>Trig Source</i>	Displays the Trig Source menu which is used to set trigger conditions.
<i>Free Run</i>	Sweep is repeated automatically.
<i>Line</i>	Sweep is executed synchronously with AC power supply.
<i>TV-V</i>	Sweep is executed synchronously with vertical synchronous signals of TV signals.
<i>TV-H</i>	Sweep is executed synchronously with horizontal synchronous signals of TV signals.
<i>Video Trig</i>	Sweep is executed synchronously with video signals.
<i>Ext Trig</i>	Sweep is executed synchronously with external trigger signals. Trigger level: 0 to + 5V
• When the OPT73, FM Demodulation function, is turned on, pressing the TRIG key displays the Trigger menu.	
<i>Free Run</i>	Sweep is repeated automatically.
<i>Line</i>	Sweep is executed synchronously with AC power supply.
<i>Video Trig</i>	Sweep is executed synchronously with video signals.
<i>Ext Trig</i>	Sweep is executed synchronously with external trigger signals. Trigger level: 0 to + 5V
<i>Slope +/-</i>	Switches between + and - of the polarity for the trigger slope.
<i>Trig Delay</i>	Sets the delay time in reference to the trigger point or sets the pre-trigger time. This is available only when the zero span is selected.
<i>Slope (TV Polarity) +/-</i>	Switches polarities between + and - for the trigger slope or video modulation of TV signals.
+	Sweep is started at the rise of a trigger. In the TV trigger mode, sweep is started synchronously with a video modulation signal of + polarity.
-	Sweep is started at the fall of a trigger. In the TV trigger mode, sweep is started synchronously with a video modulation signal of - polarity.

3.3.29 TRIG Key (Trigger)

TV Sys NTSC/PAL&SECAM

Switches the video modulation system between NTSC and PAL&SECAM.

NTSC: Selects the NTSC system for TV signals.

PAL&SECAM:

Selects the PAL&SECAM system for TV signals.

3.3.30 UTILITY Key (Utility)

<i>FM Demod</i>	Displays the FM Demod menu used in the FM demodulation mode.
<i>Range</i>	Used to switch the frequency range along the vertical axis.
<i>Deviation</i>	Displays the Deviation menu, deviation of an FM demodulated signal, positive peak deviation, negative peak deviation, and repetition frequency.
<i>Peak Delta Y</i>	Sets peak detection measurement conditions when a deviation is measured.
<i>Deviation OFF</i>	Turns the deviation measurement function off.
<i>Sensitivity</i>	Displays the Sensitivity menu, differentiates a demodulated FM signal with respect to time, and displays the differential value.
<i>Sens Range</i>	Magnifies the curve consisting of differential values in up to four positions, each of which must use any number(s) from 1, 2 and 5.
<i>Aperture %</i>	Sets the section (%) along the horizontal axis to calculate a differential value. The entire range is defined as 100%.
<i>Sensitivity OFF</i>	Turns the differential value display off.
<i>Linearity</i>	Displays the Linearity menu, and then switches to Separate Screen Mode. The reference line is displayed in the lower part of the screen.
<i>Auto Adj</i>	Automatically calculates the reference line of a demodulated FM signal using the least-square method.
<i>Sample Points</i>	Sets the number of points for the calculation using the least-square method.
<i>Offset Adj</i>	Sets the offset value of the reference line.
<i>Slope Adj</i>	Sets the inclination of the reference line.
<i>Linearity ON/OFF ON:</i>	Displays the maximum and minimum errors between a trace and the reference line.
<i>OFF:</i>	Turns off the error display between a trace and the reference line.
<i>Screen A/B</i>	Toggles the active screen between A and B.
<i>Lin Setup Quit</i>	Quits from the Linearity Setting screen.

3.3.30 UTILITY Key (Utility)

<i>Linearity ON/OFF</i>	ON: Displays the maximum and minimum errors between a trace and the reference line.
	OFF: Turns off the error display between a trace and the reference line.
<i>Demod Cal</i>	Displays the Demod Cal menu.
<i>All</i>	Performs calibrations for all of the frequency ranges.
<i>Range Only</i>	Performs the calibrations for the ranges currently set.
<i>FM Demod OFF</i>	Turns the FM demodulation display off.

3.4 List of Settings

3.4.1 Factory Defaults

The table below lists the factory defaults (for both the analyzer parameters and settings). These values are used when the **SHIFT** and **CONFIG(PRESET)** keys are pressed.

Table 3-1 Factory Defaults (R3132/N)

Parameter	Factory defaults
Center frequency	1.5GHz
Frequency span	3GHz
Reference level	0dBm (R3132), 108.8dB μ V (R3132N)
Sweep time	AUTO 20ms
Resolution bandwidth (RBW)	AUTO 3MHz
Video bandwidth (VBW)	AUTO 3MHz
Input attenuator	AUTO 10dB
Trigger mode	Free Run
Trace mode	A Write B Blank
Detector mode	A Normal B Normal
Marker	OFF
Line	OFF
Window	OFF
Title function	OFF
Vertical graduation	10dB/div

3.4.1 Factory Defaults

Table 3-2 Factory Defaults (R3162)

Parameter	Factory defaults	
Center frequency	4GHz	
Frequency span	8GHz	
Reference level	0dBm	
Sweep time	AUTO	120ms
Resolution bandwidth (RBW)	AUTO	3MHz
Video bandwidth (VBW)	AUTO	3MHz
Input attenuator	AUTO	10dB
Trigger mode	Free Run	
Trace mode	A Write	B Blank
Detector mode	A Normal	B Normal
Marker	OFF	
Line	OFF	
Window	OFF	
Title function	OFF	
Vertical graduation	10dB/div	

Table 3-3 Factory Defaults (R3172)

Parameter	Factory defaults
Center frequency	13.25GHz
Frequency span	26.5GHz
Reference level	0dBm
Sweep time	AUTO 400ms
Resolution bandwidth (RBW)	AUTO 3MHz
Video bandwidth (VBW)	AUTO 3MHz
Input attenuator	AUTO 10dB
Trigger mode	Free Run
Trace mode	A Write B Blank
Detector mode	A Normal B Normal
Marker	OFF
Line	OFF
Window	OFF
Title function	OFF
Vertical graduation	10dB/div

3.4.1 Factory Defaults

Table 3-4 Factory Defaults (R3182)

Parameter	Factory defaults
Center frequency	20GHz
Frequency span	40GHz
Reference level	0dBm
Sweep time	AUTO 600ms
Resolution bandwidth (RBW)	AUTO 3MHz
Video bandwidth (VBW)	AUTO 3MHz
Input attenuator	AUTO 10dB
Trigger mode	Free Run
Trace mode	A Write B Blank
Detector mode	A Normal B Normal
Marker	OFF
Line	OFF
Window	OFF
Title function	OFF
Vertical graduation	10dB/div

3.4.2 Defaults Configuration Values

These are the default settings used when the *Default Config* softkey is pressed.

Table 3-5 Values for Default Config

Parameter	Default Setting
Copy destination setting	Printer
Printer type	PCL
Screen output mode	COLOR
Menu output	ON
Paper Feed	ON
Bitmap output mode	COLOR
Bitmap compression mode	OFF
Automatic file number increment	ON
Bitmap file number	0
GPIB address	8
Baud rate	9600bps
Data length	8
Stop bit length	1
Parity bit type	None
XON/XOFF signal output	ON
Date display mode	LONG
Date format	Year/month/date
Screen color	Color 1
Reverse video	OFF

4 REMOTE PROGRAMING

4.1 GPIB Command Index

This GPIB command index can be used as the index for Chapter 4.

<u>GPIB Command</u>	<u>Pages</u>	<u>GPIB Command</u>	<u>Pages</u>
-	4-48	ACPST USR	4-39
%	4-48	ADG [ON]	4-39
*CLS	4-45	ADG OFF	4-39
*ESE	4-45	ADLA	4-28
*ESR	4-45	AF	4-41
*IDN	4-46	AG	4-28
*RST	4-44	AGC	4-28
*SRE	4-45	AGCNT	4-28
*STB	4-45	AGL	4-24
*TST	4-45	AGL OFF	4-24
+	4-48	AGL ON	4-24
.	4-48	AGP	4-28
0	4-48	AGR	4-28
1	4-48	AGS	4-28
2	4-48	AGSGL	4-28
3	4-48	AL	4-25
4	4-48	AMAX OFF	4-28
5	4-48	AMAX ON	4-28
6	4-48	AMIN OFF	4-28
7	4-48	AMIN ON	4-28
8	4-48	AMMOD [ON]	4-35
9	4-48	AMMOD OFF	4-35
AA	4-25	AN0	4-41
AAVG OFF	4-28	AN1	4-41
AAVG ON	4-28	AN2	4-41
AB	4-28	AN3	4-41
ABA	4-28	AN4	4-41
ACP	4-39	ANNOT OFF	4-46
ACP [ON]	4-39	ANNOT ON	4-46
ACP OFF	4-39	ANORM OFF	4-47
ACPBSW OFF	4-39	ANORM ON	4-47
ACPBSW ON	4-39	ANT OFF	4-41
ACPEXE	4-39	ANT0	4-41
ACPREF	4-39	ANT1	4-41
ACPSCR CARR	4-39	ANT2	4-41
ACPSCR FULL	4-39	ANT3	4-41
ACPSCR SEPA	4-39	ANT4	4-41
ACPST DEF	4-39	APAVG OFF	4-28
ACPST MNL	4-39	APAVG ON	4-28

4.1 GPIB Command Index

AR.....	4-47	CHTBL1 ENBL.....	4-23
AS.....	4-26	CHTBL2 DSBL.....	4-23
ASTORE.....	4-29	CHTBL2 ENBL.....	4-23
AT.....	4-25	CHTBL3 DSBL.....	4-23
AUNITS DBM.....	4-25	CHTBL3 ENBL.....	4-23
AUNITS DBMV.....	4-25	CLALL.....	4-42
AUNITS DBUV.....	4-25	CLCREF.....	4-42
AUNITS V.....	4-25	CLDREF.....	4-42
AUNITS W.....	4-25	CLFREF.....	4-42
AV.....	4-28	CLGAIN.....	4-42
AW.....	4-28	CLLOG.....	4-42
BA.....	4-25	CLMAG.....	4-42
BAA.....	4-28	CLN.....	4-42
BAVG OFF.....	4-29	CLPBW.....	4-42
BAVG ON.....	4-29	CLRBW.....	4-42
BB.....	4-28	CLSREF.....	4-42
BG.....	4-29	CLSTEP.....	4-42
BGC.....	4-29	CNO.....	4-38
BGCNT.....	4-29	CN1.....	4-38
BGP.....	4-29	CN2.....	4-38
BGR.....	4-29	CN3.....	4-38
BGS.....	4-29	CNAVG.....	4-36
BGSGL.....	4-29	CNAVG [ON,].....	4-36
BMAX OFF.....	4-28	CNAVG OFF.....	4-36
BMAX ON.....	4-28	CNIS.....	4-36
BMIN OFF.....	4-29	CNIS OFF.....	4-36
BMIN ON.....	4-29	CNIS ON.....	4-36
BMP.....	4-44	CNOFSDEL.....	4-36
BND.....	4-23	CNOFSIN.....	4-36
BNDLC OFF.....	4-23	CNRES.....	4-38
BNDLC ON.....	4-23	CNSIG OFF.....	4-36
BPAVG OFF.....	4-29	CNSIG ON.....	4-36
BPAVG ON.....	4-29	CONTS.....	4-26
BSTORE.....	4-29	COUNT OFF.....	4-38
BV.....	4-28	COUNT ON.....	4-38
BW.....	4-28	CP OFF.....	4-32
CA.....	4-22	CP ON.....	4-32
CARRBS.....	4-39	CPLMK [ON].....	4-32
CC OFF.....	4-42	CPLMK OFF.....	4-32
CC ON.....	4-42	CR ANT.....	4-41
CDB OFF.....	4-35	CR LVL.....	4-41
CDB ON.....	4-35	CR OFF.....	4-41
CF.....	4-22	CR ON.....	4-41
CFCH.....	4-23	CRDEL.....	4-41
CH.....	4-23	CRIN.....	4-41
CHED1.....	4-23	CS.....	4-22
CHED2.....	4-23	CSBSDEL.....	4-39
CHED3.....	4-23	CSBSIN.....	4-39
CHEDDEL.....	4-23	DB.....	4-48
CHEDIN.....	4-23	DC0.....	4-35
CHTBL1 DSBL.....	4-23	DC1.....	4-35

DC2.....	4-35	FMLA	4-47
DD.....	4-25	FMLIN OFF.....	4-47
DEL.....	4-43	FMLIN ON	4-47
DELn.....	4-43	FMLMAX.....	4-47
DET.....	4-29	FMLMD OFF	4-47
DET NEG	4-29	FMLMD ON.....	4-47
DET NRM.....	4-29	FMLMIN	4-47
DET POS	4-29	FMLOFS.....	4-47
DET SMP.....	4-29	FMLSLP	4-47
DETb	4-29	FMLSMP.....	4-47
DETb NEG.....	4-29	FMMEAS.....	4-35
DETb NRM.....	4-29	FMMEAS [ON]	4-35
DETb POS.....	4-29	FMMEAS OFF	4-35
DETb SMP.....	4-29	FMMODF	4-35
DL	4-31	FMMODFON	4-35
DL OFF.....	4-31	FMNPK.....	4-47
DL ON	4-31	FMONLY.....	4-47
DL0	4-45	FMPPK	4-47
DL1	4-45	FMRNG	4-46
DL2	4-45	FMRPF.....	4-47
DL3	4-45	FMSEN OFF.....	4-46
DL4	4-45	FMSEN ON	4-46
DS	4-34	FMSRNG	4-47
DY.....	4-33	FMSRNGS.....	4-47
E.....	4-48	FMSUN.....	4-46
EMCDET NRM.....	4-41	FO [ON,]	4-22
EMCDET PEAK.....	4-41	FO OFF.....	4-22
EMCDET QP	4-41	FPL.....	4-30
ENT.....	4-48	FPU	4-30
ERRNO	4-46	FS	4-22
EX	4-27	FX	4-32
EXP.....	4-48	FX OFF.....	4-32
FA	4-22	FX ON.....	4-32
FACH.....	4-23	GEX OFF.....	4-26
FACHO	4-23	GEX ON	4-26
FB.....	4-22	GTEX.....	4-26
FBCH	4-23	GTPOS.....	4-26
FBCHO	4-23	GTSLP -	4-26
FC OFF	4-42	GTSLP +	4-26
FC ON.....	4-42	GTSLP FALL.....	4-26
FINPMD CH1	4-23	GTSLP RISE.....	4-26
FINPMD CH2.....	4-23	GTSRC.....	4-26
FINPMD FREQ	4-23	GTSRC EXT.....	4-26
FMA LL	4-47	GTSRC TVH	4-26
FMAPR	4-47	GTSRC TVV	4-26
FMAVG	4-47	GTSWP OFF.....	4-26
FMDEM OFF	4-46	GTSWP ON	4-26
FMDEM ON	4-46	GTTVH	4-26
FMDEV	4-47	GTWID	4-26
FMDEV OFF.....	4-47	GZ	4-48
FMDEV ON.....	4-47	HCCMPRS OFF	4-44

4.1 GPIB Command Index

HCCMPRS ON.....	4-44	LMTB OFF.....	4-30
HCDEV FDD.....	4-44	LMTB ON.....	4-30
HCDEV PRT.....	4-44	LMTBDEL.....	4-30
HCFILE.....	4-44	LMTBIN.....	4-30
HCIMAG COL.....	4-44	LOF.....	4-44
HCIMAG GRY.....	4-44	LON.....	4-44
HCIMAG MON.....	4-44	LS.....	4-22
HCIMAG SCOL.....	4-44	LTSP.....	4-22
HCOPY.....	4-44	LVF OFF.....	4-24
HS OFF.....	4-25	LVF ON.....	4-24
HS[ON].....	4-25	LVFDEL.....	4-24
HZ.....	4-48	LVFIN.....	4-24
IMAVG.....	4-37	M0.....	4-34
IMAVG [ON,].....	4-37	M1.....	4-34
IMAVG OFF.....	4-37	M2.....	4-34
IMGSP OFF.....	4-23	M3.....	4-34
IMGSP ON.....	4-23	MA.....	4-48
IMHS OFF.....	4-37	MC.....	4-34
IMHS ON.....	4-37	MDF1.....	4-32
IMLS3.....	4-37	MDF2.....	4-32
IMLS5.....	4-37	MDL1.....	4-32
IMLS7.....	4-37	MDL2.....	4-32
IMLS9.....	4-37	MF.....	4-32
IMM OFF.....	4-37	MFL.....	4-32
IMM ON.....	4-37	MIS.....	4-32
IMMDF.....	4-37	MK.....	4-32, 4-33
IMMREF.....	4-37	MKBW.....	4-35
IMMRES.....	4-37	MKCF.....	4-34
IMODR.....	4-37	MKCS.....	4-34
IMPFC OFF.....	4-37	MKD.....	4-32
IMPFC ON.....	4-37	MKMKS.....	4-34
IP.....	4-44	MKN.....	4-32, 4-33
KZ.....	4-48	MKOFF.....	4-32
LIMAPOS ABS.....	4-30	MKRL.....	4-34
LIMAPOS BOTM.....	4-30	MKTRACE TRA.....	4-32
LIMAPOS CENT.....	4-30	MKTRACE TRB.....	4-32
LIMAPOS REL.....	4-30	ML.....	4-32
LIMAPOS TOP.....	4-30	MLF1.....	4-33
LIMASFT.....	4-30	MLF10.....	4-33
LIMPOS ABS.....	4-30	MLF2.....	4-33
LIMPOS CENT.....	4-30	MLF3.....	4-33
LIMPOS LFT.....	4-30	MLF4.....	4-33
LIMPOS REL.....	4-30	MLF5.....	4-33
LIMSFT.....	4-30	MLF6.....	4-33
LIMTYP FREQ.....	4-30	MLF7.....	4-33
LIMTYP TIME.....	4-30	MLF8.....	4-33
LL1.....	4-25	MLF9.....	4-33
LMTA OFF.....	4-30	MLN1.....	4-33
LMTA ON.....	4-30	MLN10.....	4-33
LMTADEL.....	4-30	MLN2.....	4-33
LMTAIN.....	4-30	MLN3.....	4-33

MLN4.....	4-33	OHM50.....	4-25
MLN5.....	4-33	OHM75.....	4-25
MLN6.....	4-33	OBW.....	4-38
MLN7.....	4-33	SPM.....	4-39
MLN8.....	4-33	OPF.....	4-30
MLN9.....	4-33	OPR.....	4-45
MLT OFF.....	4-33	OPREVT.....	4-45
MLT ON.....	4-33	PER.....	4-48
MLTSCR FT.....	4-31	PFC OFF.....	4-30
MLTSCR OFF.....	4-31	PFC ON.....	4-30
MLTSCR TT.....	4-31	PFEED OFF.....	4-44
MLTSCR ZM.....	4-31	PFEED ON.....	4-44
MMS.....	4-32	PFJ.....	4-30
MN.....	4-32, 4-33	PJAVG [ON].....	4-36
MO.....	4-32	PJAVG OFF.....	4-36
MPA.....	4-32	PJIT.....	4-36
MPM.....	4-32	PJIT OFF.....	4-36
MR.....	4-34	PJIT ON.....	4-36
MS.....	4-48	PJSIG OFF.....	4-36
MSEC.....	4-48	PJSIG ON.....	4-36
MTCF.....	4-34	PJSRTO.....	4-36
MTC.....	4-34	PJSTPO.....	4-36
MTMKS.....	4-34	PKCF.....	4-34
MTSP.....	4-34	PKLST.....	4-33
MV.....	4-48	PKRL.....	4-34
MW.....	4-48	PKTHIRD.....	4-35
MXE.....	4-23	PKZOOM.....	4-22
MXI.....	4-23	PLS FREQ.....	4-33
MZ.....	4-48	PLS LEVEL.....	4-33
NI.....	4-35	PLS OFF.....	4-33
NIC.....	4-35	PPA.....	4-22
NIF.....	4-35	PPM.....	4-22
NIM.....	4-35	PRT COL.....	4-44
NIU.....	4-35	PRT GRY.....	4-44
NORM EX.....	4-47	PRT MOL.....	4-44
NORM OFF.....	4-47	PRT MOS.....	4-44
NORM ON.....	4-47	PRT SCOLL.....	4-44
NQST OFF.....	4-39	PRT SCOLS.....	4-44
NQST ON.....	4-39	PRTCMD ESC.....	4-44
NSEC.....	4-48	PRTCMD ESCR.....	4-44
NV.....	4-48	PRTCMD PCL.....	4-44
NXL.....	4-32	PS.....	4-32
NXP.....	4-32	PSL.....	4-33
NXR.....	4-32	PSN.....	4-33
OBW.....	4-38	PSU.....	4-33
OBW OFF.....	4-38	PU.....	4-35
OBWEXE.....	4-38	PWAVG.....	4-38
OBWPER.....	4-38	PWCH.....	4-38
OBWST DEF.....	4-39	PWCHST DEF.....	4-38
OBWST MNL.....	4-39	PWCHST MNL.....	4-38
OBWST USR.....	4-39	PWCHST USR.....	4-38

4.1 GPIB Command Index

PWM.....	4-38	SPMST DEF.....	4-39
PWTM.....	4-38	SPMST MNL.....	4-39
PWTOTAL.....	4-38	SPMST USR.....	4-39
QA.....	4-41	SPRCNT [ON.].....	4-40
QP0.....	4-41	SPRCNT OFF.....	4-40
QP1.....	4-41	SPRDEL.....	4-40
QP2.....	4-41	SPRFIN.....	4-40
QP3.....	4-41	SPRIN.....	4-40
QPAUTO.....	4-41	SPRJ LOW.....	4-40
RB.....	4-25	SPRJ UP.....	4-40
RC.....	4-43	SPRTBL.....	4-40
RCn.....	4-43	SPRTIN.....	4-40
RFACT.....	4-39	SPURI.....	4-40
RFE.....	4-44	SPURI FREQ.....	4-40
RFI.....	4-44	SPURI OFF.....	4-40
RL.....	4-25	SPURI TIME.....	4-40
RLN.....	4-31	SQE [ON.].....	4-35
RLN OFF.....	4-31	SQE OFF.....	4-35
RLN ON.....	4-31	SR.....	4-26
RO [ON.].....	4-25	ST.....	4-26
RO OFF.....	4-25	SV.....	4-43
RQS.....	4-45	SVANT OFF.....	4-43
S0.....	4-45	SVANT ON.....	4-43
S1.....	4-45	SVCH OFF.....	4-43
S2.....	4-45	SVCH ON.....	4-43
SAM.....	4-35	SVLIM 1.....	4-43
SC.....	4-48	SVLIM 2.....	4-43
SCRSEL TRA.....	4-31	SVLIM 3.....	4-43
SCRSEL TRB.....	4-31	SVLIM OFF.....	4-43
SD.....	4-35	SVLIM ON.....	4-43
SDV.....	4-35	SVLVL OFF.....	4-43
SETDATE DATE.....	4-46	SVLVL ON.....	4-43
SETTIME TIME.....	4-46	SVn.....	4-43
SFM.....	4-35	SVNRM OFF.....	4-43, 4-47
SG.....	4-32	SVNRM ON.....	4-43, 4-47
SG OFF.....	4-32	SVOLSS OFF.....	4-43
SG ON.....	4-32	SVOLSS ON.....	4-43
SI.....	4-26	SVSET OFF.....	4-43
SIGID OFF.....	4-23	SVSET ON.....	4-43
SIGID ON.....	4-23	SVSPR OFF.....	4-43
SIMS OFF.....	4-40	SVSPR ON.....	4-43
SIMS ON.....	4-40	SVTRC OFF.....	4-43
SN.....	4-26	SVTRC ON.....	4-43
SNGLS.....	4-26	SW.....	4-26
SOF.....	4-35	SWM.....	4-26
SON.....	4-35	SWPCNT.....	4-28, 4-29
SP.....	4-22	SYMRT.....	4-39
SPM.....	4-39	TA.....	4-28
SPM OFF.....	4-39	TAA.....	4-45
SPMMOD ABS.....	4-40	TAB.....	4-45
SPMMOD REL.....	4-40	TB.....	4-28

TBA	4-45
TBB.....	4-45
TG	4-47
TGA	4-47
TGF.....	4-47
TGL.....	4-47
TGM.....	4-47
TN	4-38
TPL	4-29, 4-44
TPS.....	4-29, 4-44
TRGDT	4-27
TRGSRC	4-27
TRGSRC EXT	4-27
TRGSRC FREE	4-27
TRGSRC LINE.....	4-27
TRGSRC TVH.....	4-27
TRGSRC TVV.....	4-27
TRGSRC VIDEO	4-27
TRIGSLP-	4-27
TRIGSLP FALL	4-27
TRIGSLP RISE.....	4-27
TRIGSLP+	4-27
TS	4-26
TVH	4-27
TVHNT	4-27
TVHPS	4-27
US	4-48
USEC	4-48
UV	4-48
VA.....	4-25
VB.....	4-25
VI	4-27
VIDMOD	4-35
VIDMOD [ON].....	4-35
VIDMOD OFF.....	4-35
VOLT	4-48
WDO OFF.....	4-31
WDO ON	4-31
WDOSWP OFF	4-31
WDOSWP ON	4-31
WDX	4-31, 4-38
WLX	4-31, 4-38
WRBW OFF	4-25
WRBW ON.....	4-25
XDB	4-35
XDL	4-35
XDR	4-35
ZMPOS	4-31
ZMWID	4-31
ZS	4-22

4.2 GPIB Remote Programming

4.2 GPIB Remote Programming

The spectrum analyzer is equipped with a GPIB (General Purpose Interface Bus) that complies with IEEE Standard 488.1-1978. This bus allows you to attach and use an external device to remotely control the spectrum analyzer.

4.2.1 GPIB

The GPIB is a high-performance interface bus used to connect measuring instruments to a computer. IEEE Standard 488.1-1978 defines the operations of the GPIB. Since the GPIB has a bus-configured interface, connected devices are designated by assigning them a specific address. You can connect up to 15 devices in parallel using a single bus. GPIB devices perform one or more of the following functions:

- **Talker** Sends data to the bus. Only one active talker can exist on the GPIB bus.
- **Listener** Receives data from the bus. Multiple active listeners can exist on the GPIB bus.
- **Controller** Specifies which devices are designated as “talkers” or “listeners”. Only one active controller can operate on the GPIB bus. Controllers used to control IFC and REN messages are referred to as system controllers.

When there are multiple controllers attached to the bus, the system controller becomes the active controller by default. Other devices that can act as controllers operate as addressable devices when the system is activated.

The TCT (Take Control) interface message is used to set a controller other than the system controller as the active controller. After this setting is made, the system controller becomes inactive.

The controller controls the entire system by sending interface messages or device messages to each measuring instrument. The functions of the messages are:

- **Interface message:** messages used to control the GPIB bus
- **Device message:** messages used to control specific devices

4.2.2 GPIB Setup

(1) Connecting the GPIB

The following figure shows the standard GPIB connector and how it can be connected in parallel, or “stacked” with other connectors. Attach the GPIB connectors and secure them by tightening the screws to prevent them from coming apart during use.

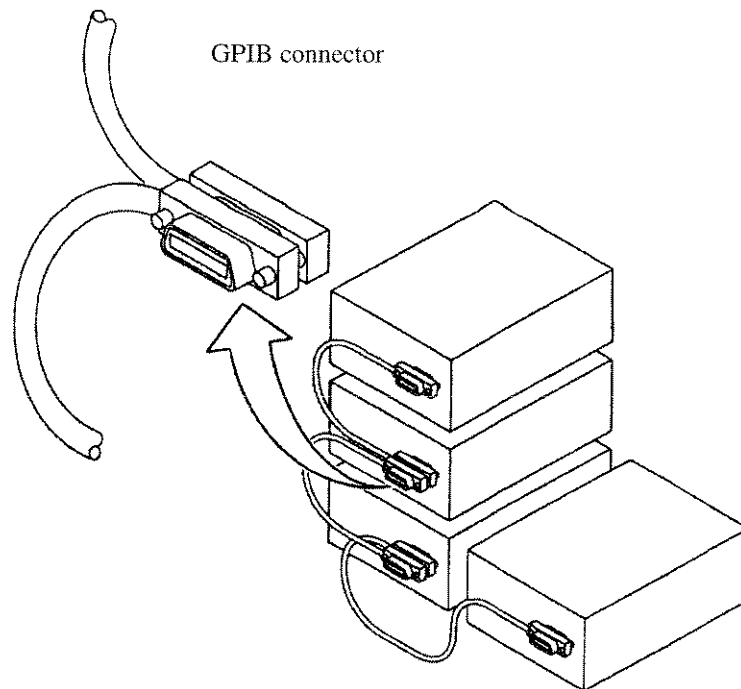

The following conditions should be observed when using a GPIB interface:

- The total GPIB cable length in a single bus system must not be more than 20 m (you can calculate the current cable length using the formula total length = $n \times 2$ m, where, n is the number of devices to be connected, including the GPIB controller).
- No more than 15 devices can be connected to a single bus system.
- There are no restrictions concerning the method of connection between cables. However, no more than three GPIB connectors should be connected to a single device, since more than this may damage the connector mounting due to excessive strain.

(Example) The total cable length in a system with five devices should be 10m or less ($2 \text{ m} \times 5 \text{ devices} = 10 \text{ m}$). There is no restriction on the length of the cables between the individual devices as long as the total length does not exceed 10 m. However, if you connect 10 devices or more, make sure that at least some of the cables attaching the devices are less than 2 m so that the total is less than 20 m.

4.2.3 GPIB Interface Functions

(2) Setting the GPIB Address

The GPIB Address dialog box is displayed.

1. Press **CONFIG** and **GPIB**.
The GPIB Address dialog box is displayed.
2. Use the data knob, the step keys, or the numeric keys to set the GPIB address as required.
3. Press **ENTER (Hz)** to set the address.

(3) Turning the display off

If the screen display is turned off, the speed of measurements made using GPIB control increases.

1. Press **CONFIG** and **Annotation ON/OFF (OFF)**.
OFF is selected, and all indications except for the trace are removed.

4.2.3 GPIB Interface Functions

Code	Description
SH1	Source handshake
AH1	Acceptor handshake
T6	Basic talker, serial polling, listener-specified talker cancel
TE0	Extended talker (not available)
L4	Basic listener function, talker-specified listener cancel
LE0	Extended listener (not available)
SR1	Service request function
RL1	Remote, local, local lockout
PP0	Parallel polling (not available)
DC1	Device clear
DT0	Device trigger (not available)
C0	System controller (not available)
E1	Using open-collector bus driver

4.2.4 Responses to Interface Messages

The IEEE Standard 488.1-1978 defines how the spectrum analyzer responds to interface messages. The responses are described in this section.

For information on how to send interface messages to the spectrum analyzer, refer to the instruction manual of the controller you are using.

(1) Interface Clear (IFC)

The IFC message is transmitted directly to the spectrum analyzer through a signal line. The message allows the spectrum analyzer to stop the operation of the GPIB bus. Although all input/output operation is stopped, the input/output buffer is not cleared. Note that the DCL is used to clear the buffer.

(2) Remote Enable (REN)

The REN message is transmitted directly to the spectrum analyzer through a signal line. If the spectrum analyzer is specified as a listener when the message is true, the spectrum analyzer is in remote mode. The spectrum analyzer remains in remote mode until the GTL message is received, REN becomes false, or you press the **LOCAL** key.

When the spectrum analyzer is in local mode, it ignores all received data, and key inputs (except for LOCAL key input) and when the spectrum analyzer is in LOCAL LOCKOUT mode, it ignores all key input.

(3) Serial Polling Enable (SPE)

When the spectrum analyzer is receiving a message from an external device, it is in serial polling mode. If the spectrum analyzer is specified as a talker in this mode, it sends status bytes instead of normal messages. The spectrum analyzer remains in the serial polling mode until the SPD (Serial Polling Disable) message or the IFC message is received.

When the spectrum analyzer sends an SRQ (Service Request) message to the controller, bit 6 (RQS bit) of the response data is set to 1 (true). When the spectrum analyzer has finished sending this message, the RQS bit reverts to 0 (false). The SRQ message is sent directly through a signal line.

(4) Device Clear (DCL)

When the spectrum analyzer receives a DCL message, it performs the following actions:

- Clears the input and output buffers.
- Resets syntax analysis, execution control, and response data generation.
- Cancels all commands that prevent the remote command from being executed next.
- Cancels commands that are paused to wait for other parameters.

When the spectrum analyzer receives the DCL message, it does not do the following:

- Changes data set or stored in the spectrum analyzer.
- Interrupt front panel operation.
- Modify or interrupt any spectrum analyzer operations being executed.
- Change any status bytes other than MAV (MAV becomes 0 when the output buffer is cleared).

4.2.5 Message Exchange Protocol

(5) Selected Device Clear (SDC)

The SDC message operates in the same manner as the DCL message. However, it is executed only when the spectrum analyzer is a listener. In other cases, the SDC message is ignored.

(6) Go to Local (GTL)

The GTL message puts the spectrum analyzer into local mode. In local mode, all the operations normally accessible from the front panel are available.

(7) Local Lockout (LLO)

The LLO message puts the spectrum analyzer in the local lockout mode. If the spectrum analyzer is set to the remote mode when this is done, all operations normally available from the front panel are disabled (note that in the normal remote mode, you can perform front panel operations using the **LOCAL** key).

You can use one of the following three methods to set the spectrum analyzer to local mode from the local lockout mode:

- Send a GTL message to the spectrum analyzer
- Set the REN message to false (the local lockout mode will be canceled)
- Turn the spectrum analyzer power off and on again

4.2.5 Message Exchange Protocol

The spectrum analyzer receives program messages from controllers or other devices through the GPIB bus and generates response data. Program messages include commands, queries (commands used to query response data) and data. The procedure used to exchange these commands, queries and data is explained in this section.

(1) GPIB Buffers

The spectrum analyzer is equipped with the following two buffers:

(a) Input Buffer

The input buffer is used to store data temporarily for command analysis (it has a length of 1024 bytes so an input larger than this is ignored.)

Use either of the following two methods to clear this buffer:

- Turn the spectrum analyzer power on.
- Execute DCL or SDC.

(b) Output Buffer

The output buffer is used to store data which is going to be read from the controller (1024 bytes).

Use either of the following two methods to clear this buffer:

- Turn the spectrum analyzer power on.
- Execute DCL or SDC.

(2) Message Exchange

GPIB control between a controller and a device consists of two main elements; command message analysis (by the parser) and response data generation. These are explained below.

(a) Parser

The parser receives command messages in the order of reception from the input buffer, analyzes the syntax, and determines what the received command is.

(b) Response Data Generation

When the parser determines what the query is, the spectrum analyzer generates data in the output buffer in response (that is, to output data a query must be sent immediately before the data).

4.2.6 Command Syntax

Command programs for the spectrum analyzer are defined using the following format:

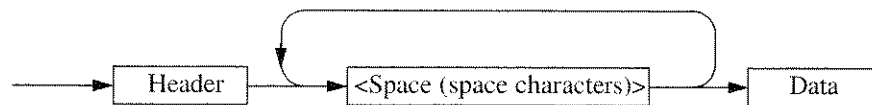

(1) Header

Two types of header are available: the common command header and the simple header. The common command header has an asterisk (*) at the beginning of the mnemonic. The simple header is a functionally independent command that has no hierarchical structure. You can form a query command by attaching a "?" in the rear of a header.

(2) Space (Space Character)

You should separate the header from the data by one or more spaces, however spaces may be omitted.

(3) Data

When the command requires multiple data, data is separated by commas. A space may be inserted before or after each comma. For more information on data types, see Section 4.2.7 "Data Formats."

(4) Writing Multiple Commands

You can write multiple commands by separating them with semicolons in one line.

4.2.7 Data Formats

4.2.7 Data Formats

The spectrum analyzer uses the following data formats for the input and output data.

(1) Numeric Data

There are three numeric data formats, any of which can be used for input. Some commands add units to the data when the data is input. The following shows the three numeric data formats.

- Integer type: NR1 format

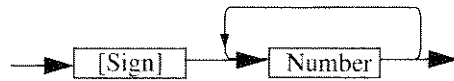

- Fixed-point type: NR2 format



- Floating-point type: NR3 format

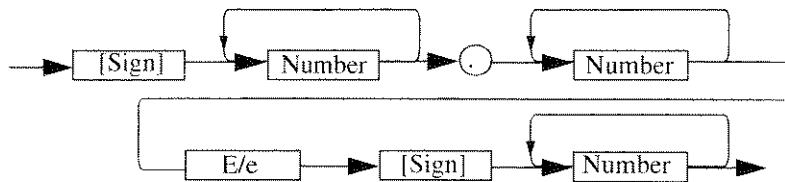

(2) Units

The table below lists the units that you can use.

Unit	Exponential	Description
GZ	10^9	Frequency
MZ	10^6	Frequency
KZ	10^3	Frequency
HZ	10^0	Frequency
VOLT	10^0	Voltage
MV	10^{-3}	Voltage
UV	10^{-6}	Voltage
NV	10^{-9}	Voltage
MW	10^{-3}	Power
DB	10^0	dB correspondence
MA	10^{-3}	Electric Current
SC	10^0	Second
MS	10^{-3}	Second
US	10^{-6}	Second
PER	10^0	Percentage
%	10^0	Percentage

4.2.8 Status Byte

The spectrum analyzer has a hierarchical status register structure which complies with IEEE Standard 488.2-1987. This is used to send information on the status of various aspects of a device to the controller. This section explains the status byte and event assignments operation models.

(1) Status Register

The spectrum analyzer uses the status register model defined by IEEE Standard 488.2-1987. This consists of a condition register, an event register and an enable register.

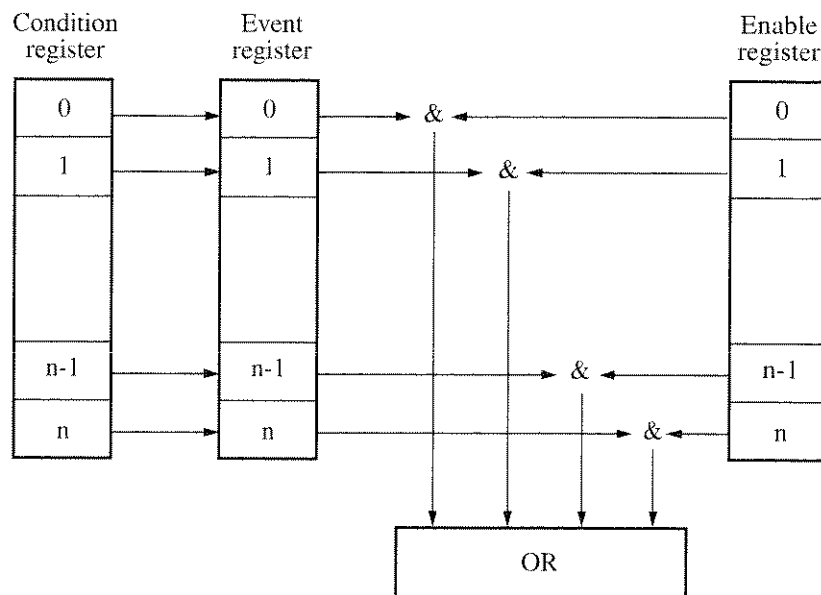

(a) Condition Register

The condition register continuously monitors the status of devices, showing their latest status. However, this register is used internally, so no data can be written into or read out from this register.

(b) Event Register

The event register latches and retains the status information from the condition register (in some cases, it retains status changes).

Once the register is set, the condition is maintained until a query command reads out the information or the register is reset by means of the *CLS command.

No data can be written into the event register.

(c) Enable Register

The enable register specifies which bit in the event register is to be used as the valid status to generate a summary. The enable register is ANDed with the event register. The OR of the result of the AND operation is generated as a summary. The summary is written into the following status byte registers.

Any data can be written into the enable register.

The following three types of status registers are used in the spectrum analyzer:

4.2.8 Status Byte

- Status byte register
- Standard event register
- Standard operation status register

The arrangement of the status registers of the spectrum analyzer are shown in Figure 4-1. The status registers are shown in detail in Figure 4-2.

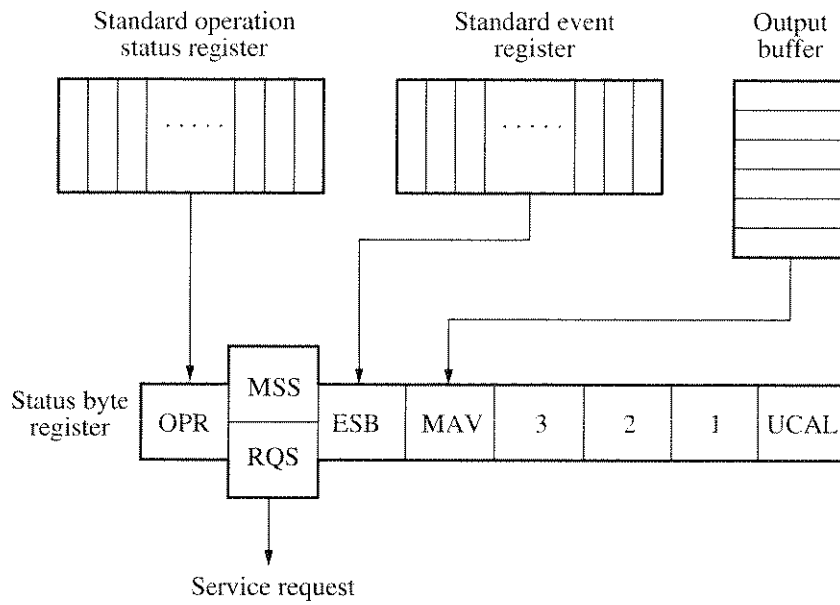

Figure 4-1 Arrangement of the Three Status Registers

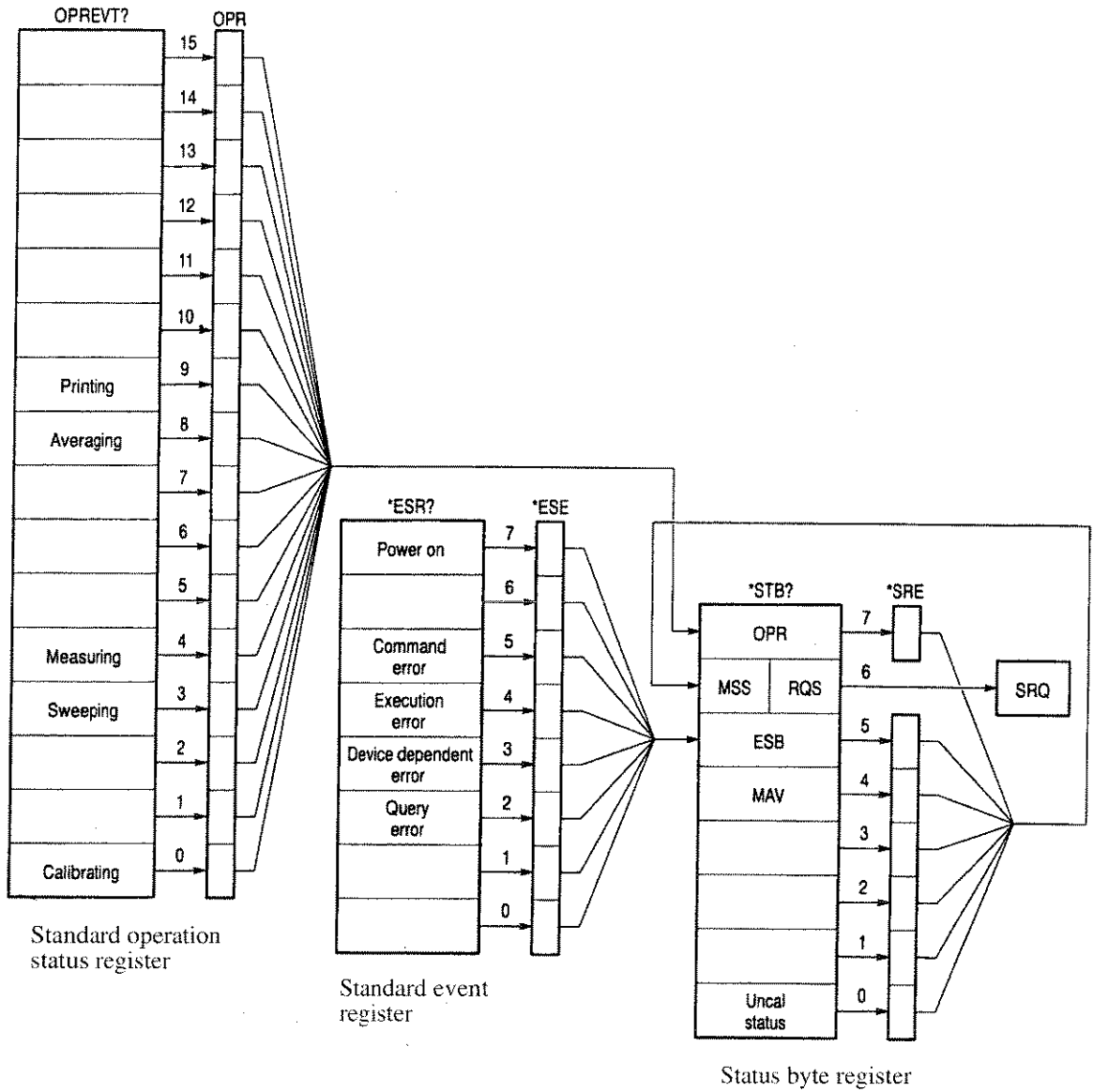

Figure 4-2 Details of the Three Status Registers

4.2.8 Status Byte

(2) Event Enable Register

Each event register has an enable register to determine which bit is available. The enable register sets the corresponding bit in decimal value.

- Set of Service Request Enable Register: *SRE
- Set of Standard Even Status Enable Register: *ESE
- Set of Operation Status Enable Register: OPR

Example: Only the Measuring bit in the operation status register is available.

The OPR bit of the status byte register is set to 1 when the Measuring bit of the operation status register is set to one.

PRINT @8;"OPR16" (An example of the program in N88BASIC)

OUTPUT 708;"*OPR16" (An example of the program for the HP200 and 300 series)

Example: The OPR (the summary of Operation Status Register) bit and ESB (the summary of Event Status Register) bit of the status byte register are available.

The MSS bit of the status byte register is set to 1 when the OPR bit or the ESB bit is set to one.

PRINT @8;"SRE160" (An example of the program in N88BASIC)

OUTPUT 708;"*SRE160" (An example of the program for the HP200 and 300 series)

(3) Standard Operation Status Register

Bit assignments for the event register (which represents the standard operation status) is listed below:

Bit	Functional definition	Description
15 to 10		This is always 0
9	Printing	This is set to 1 at the end of printing
8	Averaging	This is set to 1 when averaging is completed
7 to 5		This is always 0
4	Measuring	This is set to 1 at the end of sequence measurement
3	Sweeping	This is set to 1 when sweeping is completed
2 to 1		This is always 0
0	Calibrating	This is set to 1 when calibration data acquisition finishes

(4) Status Byte Register

The status byte register summarizes the information from the status register. In addition, a summary of the status byte register is sent to the controller as a service request. As a result, this register operates slightly differently from the status register. This section explains the status byte register. The structure of the status byte register is shown in Figure 4-3.

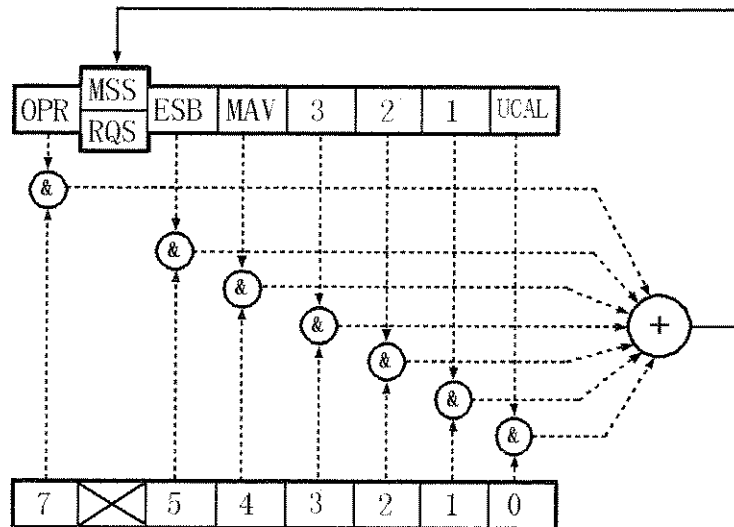

Figure 4-3 Structure of the Status Byte Register

This status byte register has the same functions as the status register, except for the following three points:

- The summary of the status byte register is written in bit 6 of the status byte register.
- Bit 6 of the enable register is always valid and cannot be changed.
- Bit 6 (MSS) of the status byte register writes the RQS of the service request.

The register responds to serial polling from the controller. On doing so, bits 0 to 5 and bit 7 of the status byte register and the RQS are read out, and then the RQS is reset to 0. Other bits are not cleared until each factor has been reset to 0.

When the *CLS and S2 commands are executed, the status byte register, the RQS bit, and the MSS bit can be cleared. Consequently, the SRQ line is now false.

4.2.8 Status Byte

The table below explains the meanings of the bits in the status byte register.

Bit	Functional definition	Description
7	OPR	The OPR bit is a summary of the standard operation status register.
6	MSS	The RQS bit is true when the MSS bit of the status byte register is set to 1. The MSS bit is the summary bit for the entire status data structure. The serial poll cannot read out the MSS bit. (However, the MSS bit is understood to be 1 when the RQS bit is 1.) To read the MSS bit, use the common command *STB?. The *STB? command can read out bit 0 to 5 and bit 7 of the status byte register and the MSS bit. In this case, neither the status byte register nor the MSS bit can be cleared. The MSS bit cannot become 0 until all the unmasked factors in the status register structure have been cleared.
5	ESB	The ESB bit is a summary of the standard event register.
4	MAV	Summary bit for the output buffer. This instrument does not use this bit.
3 to 1		This is always 0.
0	UCAL	This is set to 1 when an signal level error occurs because the sweep is too fast.

(5) Standard event register

The table below explains the meanings of the bits in the standard event register.

Bit	Functional definition	Description
7	Power on	This is set to 1 when the spectrum analyzer is switched on
6		This is always 0
5	Command Error	This is set to 1 when the parser finds a syntax error
4	Execution Error	This is set to 1 when the system fails to execute an instruction received as a GPIB command for some reason (such as out-of-range parameter)
3	Device Dependent Error	This is set to 1 when errors other than command errors, execution errors, or query errors occur
2	Query Error	This is set to 1 when no data exists or data has been deleted when the controller attempts to read out data from the spectrum analyzer
1	Request Control	Not supported in the spectrum analyzer
0	Operation Complete	Not supported in the spectrum analyzer

4.2.9 GPIB Command Codes

4.2.9 GPIB Command Codes

The following tables list the GPIB commands by function.

Listener Code Column: An asterisk (*) in the Listener Code Column indicates that the function requires numeric data together with the function code. The sign /***/ in the Listener Code Column indicates that the function requires character string data together with the function code. [ON], [ON.] and numeric data are omissible. String data such as file name, label and so on can receive characters, which are found after the command and prior to the delimiter, as input values. However, when data begins with a “/”, the characters between “/” and “/” are received as input.

Output Format Column: A comma (,) in the Output Format column indicates that multiple items are output. ON/OFF or AUTO/MANUAL in the Output Format column indicates that the code outputs 1 or 0, respectively. All frequencies are in hertz (Hz), and all times are in seconds. Levels are output in the currently displayed unit.

Table 4-1 Frequency (1 of 3)

Function	Listener Code	Talker Request	
		Code	Output Format
Center frequency	CF *	CF?	Frequency
CF Step size	CS *	CS?	Frequency
CF Step AUTO	CA	CA?	0:Manual 1:Auto
Frequency offset	ON OFF FO [ON,]* FO OFF	FO? FOON?	Frequency 0:OFF 1:ON
Start frequency	FA *	FA?	Frequency
Stop frequency	FB *	FB?	Frequency
Frequency span	SP *	SP?	Frequency
Full span	FS	—	—
Zero span	ZS	—	—
Peak zoom	PKZOOM	—	—
Last span	LTSP LS	— —	— —
Preselector	Auto Manual PPA PPM*	PPM?	Integer (-127 to 127) (*1)

(*1) Preselector is available for the R3162/72/82 only.

Table 4-1 Frequency (2 of 3)

Function	Listener Code	Talker Request	
		Code	Output Format
Frequency setting mode Frequency input mode Channel type 1 input mode Channel type 2 input mode	FINPMD FREQ FINPMD CH1 FINPMD CH2	FINPMD?	0:Frequency 1:CH Type 1 2:CH Type 2
Start channel offset	FACHO *	FACHO?	Frequency
Stop channel offset	FBCHO *	FBCHO?	Frequency
Carrier channel setting	CH *	CH?	Integer (channel number)
Center channel setting	CFCH *	CFCH?	Integer (channel number)
Start channel setting	FACH *	FACH?	Integer (channel number)
Stop channel setting	FBCH *	FBCH?	Integer (channel number)
Channel type 1 Table 1 input Table 2 input Table 3 input	(*1) CHED1 *.*.*.*.* CHED2 *.*.*.*.* CHED3 *.*.*.*.*	— — —	— — —
Table 1 for Channel type 1 Enable Disable	CHTBL1 ENBL CHTBL1 DSBL	CHTBL1?	0:Enable 1:Disable
Table 2 for Channel type 1 Enable Disable	CHTBL2 ENBL CHTBL2 DSBL	CHTBL2?	0:Enable 1:Disable
Table 3 for Channel type 1 Enable Disable	CHTBL3 ENBL CHTBL3 DSBL	CHTBL3?	0:Enable 1:Disable
Channel type 2 Input Deletion	(*2) CHEDIN *.*.*.*.* CHEDDEL	— —	— —
Internal mixer External mixer	MXI MXE	MXR?	0:INT (Internal) 1:EXT(External)
Signal Ident ON OFF	SIGID ON SIGID OFF	SIGID?	0:OFF 1:ON
Image Suppress ON OFF	IMGSP ON IMGSP OFF	IMGSP?	0:OFF 1:ON
Band selection	BND *	BND?	Integer
Band lock ON OFF	BNDLC ON BNDLC OFF	BNDLC?	0:OFF 1:ON

(*1) Specify the asterisks in order of the start channel number, stop channel number, start frequency, channel spacing and channel offset.

(*2) Specify the asterisks in order of the channel number, carrier frequency, start frequency and stop frequency.

4.2.9 GPIB Command Codes

Table 4-1 Frequency (3 of 3)

Function	Listener Code	Talker Request	
		Code	Output Format
Average loss ON OFF	AGL * AGL ON [*] AGL OFF	AGL? AGLON?	Level 0:OFF 1:ON
Loss vs Freq ON OFF	LVF ON LVF OFF	LVF?	0:OFF 1:ON
Loss vs Freq input Loss vs Freq deletion	LVFIN *,*,* (*3) LVFDEL	— —	— —

(*3) Specify asterisks (*) in the order of frequency, level (n-) and level (n+).

Table 4-2 Level

Function	Listener Code	Talker Request	
		Code	Output Format
Reference level	RL *	RL?	Level
ATT	AT*	AT?	Level
ATT auto	AA	AA?	0:Manual 1:Auto
XdB/Div	DD *	DD?	0: 10dB 1: 5dB 2: 2dB 3: 1dB
Linear × 1	LL1	—	—
Level offset	ON RO [ON,]* OFF RO OFF	RO? ROON?	Level 0:OFF 1:ON
Hi Sens	ON HS[ON] OFF HS OFF	HS?	0: OFF 1: ON
Input	50 Ω OHM50 75 Ω OHM75	OHM?	0:50Ω 1:75Ω (*1)
Display unit	dBm AUNITS DBM dBmV AUNITS DBMV dBμV AUNITS DBUV Volts AUNITS V Watts AUNITS W	AUNITS?	0:dBm 1:dBmV 2:dBμV 5:V 6:W

Table 4-3 BW

Function	Listener Code	Talker Request	
		Code	Output Format
RBW	RB*	RB?	Frequency (*3)
RBW auto	BA	BA?	0:Manual 1:Auto
VBW	VB*	VB?	Frequency (*2)
VBW auto	VA	VA?	0:Manual 1:Auto
Couple ALL auto	AL	AL?	0:Manual 1:Auto
Wide RBW	ON WRBW ON OFF WRBW OFF	WRBW?	0:OFF 1:ON

(*1) Only the R3132 can use both 50 Ω and 75 Ω as the input impedance.

(*2) When the wide RBW is turned on, the VBW is set at 0 Hz.

(*3) The RBW is set to 0 Hz when OPT73 (FM Demod) is turned on, and Range is set to 500 kHz/ or more.

4.2.9 GPIB Command Codes

Table 4-4 Sweep

Function	Listener Code	Talker Request	
		Code	Output Format
Sweep time	SW*	SW?	Sweep Time
	ST*	ST?	Sweep Time
SWP auto	AS	AS?	0:Manual 1:Auto
Sweep mode	—	SWM?	0:Normal & Full 1:Normal & Win 20:Single & Full 21:Single & Win
Sweep mode :Normal	CONTS SN	— —	— —
Sweep mode :Single	SI SNGLS	— —	— —
Take Sweep (Used to wait until the sweep is complete.)	TS	—	—
Sweep Reset & Start	SR	—	—
Gate Sweep ON OFF	GTSWP ON GTSWP OFF	GTSWP?	0:OFF 1:ON
Gate position	GTPOS *	GTPOS?	Time
Gate width	GTWID *	GTWID?	Time
Gate Slope - Gate Slope +	GTSLP - GTSLP FALL GTSLP + GTSLP RISE	GTSLP?	0:+ 1:-
Gate Source	—	GTSRC?	3:TV-V 4:TV-H 5:EXT
Gate Source EXT Trigger TV-V TV-H	GTSRC EXT GTEX* GTSRC TVV GTSRC TVH GTTVH*	— GTEX? — — GTTVH?	— Level (Real number) — — No. (Integer)
External Gate IN ON	GEX ON	GEX?	0:OFF 1:ON
	OFF	GEX OFF	GEXON? 0:OFF 1:ON

Table 4-5 Trigger

Function	Listener Code	Talker Request	
		Code	Output Format
Trigger Mode	---	TRGSRC?	0:Free RUN 1:Line 2:Video 3:TV-V 4:TV-H 5:Ext.
FREE RUN	TRGSRC FREE	---	---
LINE Trigger	TRGSRC LINE	---	---
VIDEO Trigger	TRGSRC VIDEO VI *	---	---
		VI?	%(Integer)
External Trigger	TRGSRC EXT EX *	---	---
		EX?	Level (Real number)
TV-V Trigger	TRGSRC TVV	---	---
TV-H Trigger	TRGSRC TVH TVH *	---	---
		TVH?	No.(Integer)
Trigger Slope +	TRIGSLP+	TRIGSLP?	0: +
Trigger Slope -	TRIGSLP RISE TRIGSLP- TRIGSLP FALL		1: -
TV system NTSC PAL&SECAM	TVHNT TVHPS	TVSYS?	1: NTSC 0: PAL&SECAM
Trigger Delay	TRGDT *	TRGDT?	Time

4.2.9 GPIB Command Codes

Table 4-6 Trace (1 of 2)

Function	Listener Code	Talker Request	
		Code	Output Format
Trace A	—	TA?	HI LOW 0: 0: Write 1:NORM 1: View 2:A-DL→A 2: Blank 3:A-B→A 3: Max Hold 4:B-A→A 4: Min Hold 5: 5: Averaging 6: 6: Power AVG
A write	AW	—	—
A view	AV	—	—
A blank	AB	—	—
A max hold A max hold OFF	AMAX ON AMAX OFF	AMAX?	0:OFF 1:ON
A min hold A min hold OFF	AMIN ON AMIN OFF	AMIN?	0:OFF 1:ON
A Averaging times	SWPCNT * AG *	SWPCNT? AG?	Average times Average times
Start	AAVG ON AGR	AAVG?	0:OFF 1:ON
Stop	AAVG OFF AGS		
Pause	AGP	AGP?	0:Continue
Continue	AGC		1:Pause
1 time continuous	AGSGL AGCNT	AGSGL?	0:Continuous 1:1 time
Power Average A ON OFF	APAVG ON APAVG OFF	APAVG?	0: OFF 1: ON
Pause	AGP	AGP?	0: Continue
Continue	AGC		1: Pause
1 time continuous	AGSGL AGCNT	AGSGL?	0: Continuous 1: 1 time
Math A	A-B→A B-A→A A-DL→A	ABA BAA ADLA	— — —
Trace B	—	TB?	0:Write 1:View 2:Blank 3:Max Hold 4:Min Hold 5:Averaging 6:Power AVG
B write	BW	—	—
B view	BV	—	—
B blank	BB	—	—
B max hold B max hold OFF	BMAX ON BMAX OFF	BMAX?	0:OFF 1:ON

Table 4-6 Trace (2 of 2)

Function	Listener Code	Talker Request	
		Code	Output Format
B min hold B min hold OFF	BMIN ON BMIN OFF	BMIN?	0:OFF 1:ON
B Averaging times Start Stop Pause Continue 1 time continuous	SWPCNT * BG *	SWPCNT? BG?	Average times Average times
	BAVG ON BGR BAVG OFF BGS	BAVG?	0:OFF 1:ON
	BGP BGC	BGP?	0:Continue 1:Pause
	BGSSL BGCNT	BGSSL?	0:Continuous 1:1 time
Power Average B ON OFF Pause Continue 1 time continuous	BPAVG ON BPAVG OFF	BPAVG?	0: OFF 1: ON
	BGP BGC	BGP?	0: Continue 1:Pause
	BGSSL BGCNT	BGSSL?	0: Continuous 1: 1 time
Store A → B Store B → A	BSTORE ASTORE	— —	— —
Number of trace points 501 Number of trace points 1001	TPS TPL	TP?	0:501 1:1001
Director Mode A Normal Positive Negative Sample	DET NRM DET POS DET NEG DET SMP	DET?	0:Normal 1:Positive 2:Negative 3:Sample
Director Mode B Normal Positive Negative Sample	DETB NRM DETB POS DETB NEG DETB SMP	DETB?	0:Normal 1:Positive 2:Negative 3:Sample

4.2.9 GPIB Command Codes

Table 4-7 Pass/Fail

Function	Listener Code	Talker Request	
		Code	Output Format
Pass/Fail judgement ON OFF	PFC ON PFC OFF	PFC?	0:OFF 1:ON
Reading the judgment result	—	PFJ?	0:Pass 1:Fail
Reading the judgment result (in detail)	—	OPF?	0:Pass 1:Fail(Upper) 2:Fail(Lower) 3:Fail(Both) 4>Error
Upper Fail Point Lower Fail Point	— —	FPU? FPL?	n<DLM> f1.11<DLM>... n<DLM> f1.11<DLM>...(*1)
Frequency Domain input selection Time Domain input selection	LIMTYP FREQ LIMTYP TIME	LIMTYP?	0:Freq 1:Time (*2)
X-position mode: Absolute Relative (Left) Relative(Center)	LIMPOS ABS LIMPOS REL LIMPOS LFT LIMPOS CENT	LIMPOS?	0:Absolute 1:Relative(Left) 2:Relative(Center)
Y-position mode: Absolute Relative(Top) Relative(Bottom) Relative(Center)	LIMAPOS ABS LIMAPOS REL LIMAPOS TOP LIMAPOS BOTM LIMAPOS CENT(*3)	LIMAPOS?	0:Absolute 1:Relative(Top, Center) 2:Relative(Bottom)
X-offset	LIMSFT *	LIMSFT?	Frequency/Time
Y-offset	LIMASFT *	LIMASFT?	Level
Limit Line 1 ON OFF Data input Data erase	LMTA ON LMTA OFF LMTAIN *,* LMTADEL	LMTA? — —	0:OFF 1:ON (*2)(*4) (*2)
Limit Line 2 ON OFF Data input Data erase	LMTB ON LMTB OFF LMTBIN *,* LMTBDEL	LMTB? — —	0:OFF 1:ON (*2) (*2)

(*1) n = Number of points fn, ln = Frequency (Time), Level <DLM> = Delimiter

(*2) To use this function, first select Domain using the LIMTYP command.

(*3) Enabled when OPT73 (FM Demod) is turned on. Relative (Top) and Relative (Bottom) cannot be used.

(*4) To enter limit line data used with OPT73 (FM Demod), first turn FM Demod on.

To enter limit line data used with OPT73 sensitivity measurements, first turn sensitivity on.

Table 4-8 Display

Function	Listener Code	Talker Request	
		Code	Output Format
Display Line Level ON OFF	DL * DL ON [,*] DL OFF	DL? DLON?	Level 0:OFF 1:ON
Reference Line Level ON OFF	RLN RLN ON [,*] RLN OFF	RLN? RLNON?	Level 0:OFF 1:ON
Window ON OFF	WDO ON WDO OFF	WDO?	0:OFF 1:ON
Window center position	WLX *	WLX?	Frequency
Window width	WDX *	WDX?	Frequency
Window Sweep ON OFF	WDOSWP ON WDOSWP OFF	WDOSWP?	0:OFF 1:ON
Zoom F/T T/T ZOOM OFF(Screen Reset)	MLTSCR ZM MLTSCR FT MLTSCR TT MLTSCR OFF	MLTSCR?	0:OFF 1:ZOOM 2:F/T 3:T/T
Zoom position Width	ZMPOS * ZMWID *	ZMPOS? ZMWID?	Frequency/Time Frequency/Time
Activating the upper screen Activating the lower screen	SCRSEL TRA SCRSEL TRB	SCRSEL?	0:Upper 1:Lower

4.2.9 GPIB Command Codes

Table 4-9 MKR (1 of 2)

Function	Listener Code	Talker Request	
		Code	Output Format
Marker ON OFF	MN * (*1) MKOFF MO	MN?	0: OFF 1: Normal 2: Delta
Normal Marker (ΔMarker OFF)	MK * MKN *	— —	— —
ΔMarker ON	MKD *	—	—
Marker frequency	—	MF?	Frequency (Time)(*1)
Marker Level	—	ML?	Level(*1)
Frequency + Level	—	MFL?	Frequency (Time), Level(*1)
Normal marker absolute value Frequency Level	— —	MDF1? MDL1?	Normal MKR frequency Normal MKR level
ΔMarker absolute value Frequency Level	— —	MDF2? MDL2?	Delta MKR frequency Delta MKR level
FixedΔMarker ON OFF	FX ON FX OFF	FX?	0:OFF 1:ON
MKR step Size	MPM *	MPM?	Frequency (Time)
MKR step auto	MPA	MPA?	0:Manual 1:Auto
Signal Track ON OFF	SG ON SG OFF	SG?	0:OFF 1:ON
MKR Couple ON OFF	CPLMK [ON] CPLMK OFF	CPLMK?	0:OFF 1:ON
MKR move A Trace B Trace	MKTRACE TRA MKTRACE TRB	MKTRACE?	0:Blank 1:A Trace 2:B Trace
Peak Search	PS	—	—
Next Peak	NXP	—	—
Next Peak Left	NXL	—	—
Next Peak Right	NXR	—	—
Min Search	MIS	—	—
Max-Min Search	MMS	—	—
Continuous Peak? ON OFF	CP ON CP OFF	CP?	0:OFF 1:ON

(*1): When using the delta mode, the frequency or level difference is used.

Table 4-9MKR (2 of 2)

Function		Listener Code	Talker Request	
			Code	Output Format
Peak ΔY div		DY *	DY?	ΔY (real value)
Peak range Normal Upper side Lower side		PSN PSU PSL	PKRNG?	0:All 1:Upper 2:Lower
Multi Marker ON OFF		MLT ON MLT OFF	MLT?	0:OFF 1:ON
Moving the active marker		MK * MKN * MN *	— — —	— — —
Multi Marker No1 ON OFF		MLN1 * MLF1	— —	— —
Multi Marker No2 ON OFF		MLN2 * MLF2	— —	— —
Multi Marker No3 ON OFF		MLN3 * MLF3	— —	— —
Multi Marker No4 ON OFF		MLN4 * MLF4	— —	— —
Multi Marker No5 ON OFF		MLN5 * MLF5	— —	— —
Multi Marker No6 ON OFF		MLN6 * MLF6	— —	— —
Multi Marker No7 ON OFF		MLN7 * MLF7	— —	— —
Multi Marker No8 ON OFF		MLN8 * MLF8	— —	— —
Multi Marker No9 ON OFF		MLN9 * MLF9	— —	— —
Multi Marker No10 ON OFF		MLN10 * MLF10	— —	10 frequencies + ΔMKR 10 levels + ΔMKR
Multi Marker Frequency		—	MLSF?	n<DLM> f1<DLM>... (*1)
Multi Marker Level		—	MLSL?	n<DLM> l1<DLM>... (*2)
Peak List Frequency Level OFF		PLS FREQ PLS LEVEL PLS OFF	— — —	— — —
Peak list query		—	PKLST?	n<DLM> f1,l1<DLM>... (*3)

(*1) n = 11 (fixed) fn = 10 different frequencies + ΔMKR , <DLM> = Delimiter

(*2) n = 11 (fixed) ln = 10 different levels + ΔMKR , <DLM> = Delimiter

(*3) n = Number of Peaks fn, ln = Frequency (time), level <DLM> = Delimiter

4.2.9 GPIB Command Codes

Table 4-10 MKR →

Function	Listener Code	Talker Request	
		Code	Output Format
MKR → CF	MKCF MC	— —	— —
MKRΔ → CF	MTCF	—	—
MKR → REF	MKRL MR	— —	— —
PEAK → CF	PKCF	—	—
PEAK → REF	PKRL	—	—
MKRΔ → SPAN	MTSP DS	— —	— —
MKR → CF Step	MKCS M0	— —	— —
MKRΔ → CF Step	MTCS M1	— —	— —
MKR → MKR Step	MKMKS M2	— —	— —
MKRΔ → MKR Step	MTMKS M3	— —	— —

Table 4-11 Meas (1 of 3)

Function	Listener Code	Talker Request	
		Code	Output Format
Noise/Hz	NI *	NI?	Frequency
dBm/Hz ON dB μ V/ \sqrt Hz ON dBc/Hz ON Noise/Hz OFF Noise/Hz value	NIM NIU NIC NIF —	NION? NIRES?	0:OFF 1:dBm/Hz 2:dB μ V/ \sqrt Hz 3:dBc/Hz Level
XdB Down width	MKBW *	MKBW?	Level
XdB Down left right	XDB XDL XDR	— — —	— — —
XdB relative XdB abs. left XdB abs. right	DC0 DC1 DC2	DC?	0:Relative 1:Absolute (left side) 2:Absolute (right side)
Continuous dB down ON OFF	CDB ON CDB OFF	CDB?	0:OFF 1:ON
3rd Order meas	PKTHIRD	—	—
AM Modulation (%AM) AM Modulation OFF AM modulation factor	AMMOD [ON] AMMOD OFF —	AMMODON? AMMOD?	0:OFF 1:ON Value (%)
AM video modulation factor (%AM Video) AM video modulation factor OFF AM video modulation factor value	VIDMOD [ON] VIDMOD OFF —	VIDMODON? VIDMOD?	0:OFF 1:ON Value (%)
FM frequency deviation (FM Meas) FM frequency deviation OFF FM frequency deviation value Modulation frequency input ON OFF	FMMEAS [ON] FMMEAS OFF — FMMODF [ON,]* FMMODF OFF	FMMEASON? FMMEAS? FMMODF? FMMODFON?	0:OFF 1:ON Frequency Frequency 0:OFF 1:ON
Sound Mode ON (AM or FM) ON (AM) ON (FM) OFF	SON SAM SFM SOF	SD?	0:OFF 1:ON(AM) 2:ON(FM)
Volume	SDV *	SDV?	Volume (Integer)
Pause time	PU *	PU?	Time
Squelch ON Squelch OFF	SQE [ON,]* SQE OFF	SQE? SQEON?	Level 0:OFF 1:ON

4.2.9 GPIB Command Codes

Table 4-11 Meas (2 of 3)

Function	Listener Code	Talker Request	
		Code	Output Format
Phase noise measurement	C/N measurement mode ON OFF	CNIS ON CNIS OFF	CNISON? 0: OFF 1: ON
	Offset frequency data readout	---	CNIS? n<DLM> f1, l1 <DLM>...(*1)
	Table input	CNOFSIN *	--- Offset frequency
	Deleting the table	CNOFSDEL	---
	Signal track ON OFF	CNSIG ON CNSIG OFF	CNSIG? 0: OFF 1: ON
	Average number	CNAVG [ON.] * CNAVG OFF	CNAVG? CNAVGON? Integer (2 to 999) 0: OFF 1: ON
Phase jitter measurement	Phase jitter measurement mode ON OFF	PJIT ON PJIT OFF	PJITON? 0: OFF 1: ON
	Result value readout	---	PJIT? Carrier level, total SSB noise and phase jitter
	Start offset frequency	PJSRTO *	PJSRTO? Offset frequency
	Stop offset frequency	PJSTPO *	PJSTPO? Offset frequency
	Signal track ON OFF	PJSIG ON PJSIG OFF	PJSIG? 0: OFF 1: ON
	Average number	PJAVG [ON.] * PJAVG OFF	PJAVG? PJAVGON? Integer (2 to 999) 0: OFF 1: ON

(*1) n=Set number
fn=Offset frequency
ln=Level
<DLM>=Delimiter

Table 4-11 Meas (3 of 3)

Function	Listener Code	Talker Request		
		Code	Output Format	
IM measurement	IM measurement mode ON OFF	IMM ON IMM OFF	IMMON? 0: OFF 1: ON	
	Reference wave data read-out	---	IMMREF? Frequency, Level	
	Delta frequency readout	---	IMMDF? Delta frequency	
	Distortion signal data read-out	---	IMMRES? n<DLM>LL1, LJ1, UL1, UJ1<DLM>...(*1)	
	Degree setting	IMODR *	IMODR? Degree (3, 5, 7, 9)	
	Criteria input 3 rd order 5 th order 7 th order 9 th order	IMLS3 * IMLS5 * IMLS7 * IMLS9 *	IMLS3? IMLS5? IMLS7? IMLS9?	Level Level Level Level
	Pass/Fail judgment ON OFF	IMPFC ON IMPFC OFF	IMPFC? 0: OFF 1: ON	
	Average number	IMAVG * IMAVG [ON,] * IMAVG OFF	IMAVG? IMAVGON?	Integer (2 to 999) 0: OFF 1: ON
	Hi Sens (IM Meas) ON OFF	IMHS ON IMHS OFF	IMHS? 0: OFF 1: ON	

(*1) n: Result set number corresponding to the degree
 LLn: Level difference in the lower frequency signal
 LJn: Pass/Fail judgment result for the lower frequency signal
 0: Pass
 1: Fail
 -1: Judgment off
 ULn: Level difference for the upper frequency signal
 UJn: Pass/Fail judgment result for the upper frequency signal

4.2.9 GPIB Command Codes

Table 4-12 Auto Tune

Function	Listener Code	Talker Request	
		Code	Output Format
Auto Tune	TN	—	—

Table 4-13 Counter

Function	Listener Code	Talker Request	
		Code	Output Format
Resolution : 1kHz : 100Hz : 10Hz : 1Hz	CN0 CN1 CN2 CN3	CN?	0:1kHz 1:100Hz 2:10Hz 3:1Hz
Counter ON OFF	COUNT ON COUNT OFF	COUNT?	0:OFF 1:ON
Counter value	—	CNRES?	Frequency

Table 4-14 Power (1 of 3)

Function	Listener Code	Talker Request	
		Code	Output Format
Channel Power	PWCH	PWCH? PWCHON?	Level 0:OFF 1:ON
Parameter setup Default Manual Define → Default	PWCHST USR PWCHST MNL PWCHST DEF	PWCHST?	0:(Unused) 1:Default 2:Manual
Total Power	PWTOTAL	PWTOTAL? PWTOTALON?	Level 0:OFF 1:ON
Average Power	PWAVG	PWAVG? PWAVGON?	Level 0:OFF 1:ON
Average time	PWTM *	PWTM?	Integer (1 to 999)
Window center position	WLX *	WLX?	Frequency
Window width	WDX *	WDX?	Frequency
Power OFF	PWM	—	—
OBW Execution OBW OFF	OBW [ON] OBW OFF	OBWON?	0:OFF 1:ON
OBW measurement value	—	OBW?	Center,OBW
OBW %	OBWPER *	OBWPER?	OBW%
OBW real-time execution	OBWEXE	—	—

Table 4-14 Power (2 of 3)

Function	Listener Code	Talker Request	
		Code	Output Format
Parameter setup Default Manual Define → Default	OBWST USR OBWST MNL OBWST DEF	OBWST?	0:(Unused) 1:Default 2:Manual
ACP Execution ACP OFF	ACP [ON] ACP OFF	ACPON?	0:OFF 1:ON
ACP measurement value	—	ACP?	n<DLM> f1L,11L, f1H,11H<DLM>...(*1)
Reference power value	—	ACPREF?	Level
BS Window ON OFF	ACPBSW ON ACPBSW OFF	ACPBSW?	0:OFF 1:ON
ACP real-time execution	ACPEXE	—	—
Carrier Bandwidth	CARRBS *	CARRBS ?	Frequency
CS/BS table input erase	CSBSIN *,* CSBSDEL	— —	— —
ACP screen FULL SEPA CARRIER	ACPSCR FULL ACPSCR SEPA ACPSCR CARR	ACPSCR?	0:1 screen 1:Separate screen 2:1 screen (Carrier measurement)
Symbol Rate 1/T	SYMRT *	SYMRT?	Frequency
Roll Off Factor	RFACT *	RFACT?	Real number
√Nyquist filter ON OFF	NQST ON NQST OFF	NQST?	0:OFF 1:ON
Graph ON OFF	ADG [ON] ADG OFF	ADG?	0:OFF 1:ON
Parameter setup Default Manual Define → Default	ACPST USR ACPST MNL ACPST DEF	ACPST?	0:(Unused) 1:Default 2:Manual
Spectrum mask execution Spectrum mask OFF	SPM [ON] SPM OFF	SPMON?	0:OFF 1:ON
Parameter setup Default Manual Define → Default	SPMST USR SPMST MNL SPMST DEF	SPMST?	0:(Unused) 1:Default 2:Manual
Spectrum mask result	—	SPM?	ref<DLM>n<DLM>f1L,11L, f1H,11H<DLM>...(*2)

(*1) n = Number of points
fnL= nth frequency (time) Low
lnL= nth level Low
fnH= nth frequency (time) High
lnH= nth level High
<DLM> = Delimiter

(*2) ref = Reference power value
n = Number of points
fnL= nth frequency (time) Low
lnL= nth level Low
fnH= nth frequency (time) High
lnH= nth level High
<DLM> = Delimiter

4.2.9 GPIB Command Codes

Table 4-14 Power (3 of 3)

Function	Listener Code	Talker Request	
		Code	Output Format
Result display mode REL ABS	SPMMOD REL SPMMOD ABS	SPMMOD?	0:REL 1:ABS
Spurious measurement execution Freq Time Spurious measurement OFF	SPURI FREQ SPURI TIME SPURI OFF	SPURION?	0:OFF 1:Freq 2:Time
Spurious measurement result	---	SPURI?	n<DLM>, m1<DLM>,f1,l1,j1<DLM>,..., fm1,lm1,jm1<DLM>, m2<DLM>,f1,l1,j1<DLM>,..., fm2,lm2,jm2<DLM>, : : : mn<DLM>,f1,l1,j1<DLM>,..., fmn,lmn,jmn<DLM>(*1)
Table selection	SPRTBL*	SPRTBL?	Integer(*2)
Table input Freq Time	SPRIN>(*3) SPRFIN(*3) SPRTIN(*4)	---	---
Table deletion	SPRDEL(*2)	---	---
Sweep count specification ON OFF	SPRCNT [ON,]* SPRCNT OFF	SPRCNT? SPRCNTON?	Integer 0:OFF 1:ON
Pass/fail judgment value LOW UP	SPRJ LOW SPRJ UP	SPRJ?	0:LOW 1:UP
Single Measure ON OFF	SIMS ON SIMS OFF	SIMS?	0: OFF 1: ON

(*1) n=Number of measurement points (0 thru 15)

m=Number of spurious signals (0 thru 10)

f=Spurious frequency

l=Spurious level

j=Judgment result (0: Pass, 1: Fail)

<DLM>=Delimiter

(*2) (*3) (*4) Perform the corresponding operation when the spurious measurement mode is turned on.

(*3) Specify the asterisk in order of the start frequency, stop frequency, RBW, sweep time and limit level.

(*4) Specify the asterisk in order of the center frequency, RBW, sweep time and limit level.

Table 4-15 EMC

Function	Listener Code	Talker Request	
		Code	Output Format
EMC Trace Detection :QP :PEAK :Normal	EMCDET QP EMCDET PEAK EMCDET NRM	EMCDET?	0:Normal 1:QP 3:PEAK
QP BW 200Hz QP BW 9kHz QP BW 120kHz QP BW 1MHz QP BW auto	QP0 (*1) QP1 QP2 QP3 (*2) QPAUTO QA	QPAUTO? QA?	0:AUTO 1:200Hz 2:9kHz 3:120kHz 4:1MHz
Antenna Selection Dipole (TP1722) Log-periodic (UHALP9107) Biconical (BBA9106) Bilog (EMC03142) User correction Antenna OFF	ANT0 AN0 ANT1 AN1 ANT2 AN2 ANT3 AN3 ANT4 AN4 ANT OFF AF	ANT?	0:OFF 1:Dipole 2:Log-periodic 3:Biconical 4:Bilog 5:User correction
User correction ON OFF	CR ON CR OFF	— —	— —
Table input	CRIN *,* (*3)	—	—
Table erase	CRDEL	—	—
Antenna mode Level mode	CR ANT CR LVL	CR?	0:Antenna 1:level

(*1) QP BW 200 Hz is available only when the Narrow Band RBW option is installed.

(*2) Available when EMC Trace Detection is set to Peak.

(*3) The asterisks "*,*" represent a frequency and its level. Specify them in order.

4.2.9 GPIB Command Codes

Table 4-16 CAL

Function	Listener Code	Talker Request	
		Code	Output Format
CAL ALL	CLALL	---	---
Total gain	CLGAIN	---	---
IF step AMP	CLSTEP	---	---
RBW switch	CLRBW	---	---
Log linearity	CLLOG	---	---
AMPTD OFS	CLMAG	---	---
PBW	CLPBW	---	---
CAL Signal Level	CLN *	CLN?	Level
CAL 10M Reference Coarse	CLCREF *	CLCREF?	Integer (0 to 255)
CAL 10M Reference Fine	CLFREF *	CLFREF?	Integer (0 to 255)
CAL 10M Reference Default	CLDREF	---	
CAL 10M Reference Store	CLSREF	---	
f-collection ON	FC ON	FC?	0:OFF
f-collection OFF	FC OFF		1:ON
CAL collection ON	CC ON	CC?	0:OFF
CAL collection OFF	CC OFF		1:ON

Table 4-17 Save Recall

Function		Listener Code	Talker Request	
			Code	Output Format
Save Reg.		SVn (*2)	—	—
Save File		SV File name (*1)	—	—
Delete Reg.		DELn (*2)	—	—
Delete File		DEL File name (*1)	—	—
Recall Reg.		RCn (*2)	—	—
Recall File		RC File name (*1)	—	—
Save Item	Setup ON	SVSET ON	SVSET?	0:OFF
	Setup OFF	SVSET OFF		1:ON
	Trace ON	SVTRC ON	SVTRC?	0:OFF
	Trace OFF	SVTRC OFF		1:ON
	Antenna ON	SVANT ON	SVANT?	0:OFF
	Antenna OFF	SVANT OFF		1:ON
	Normalize ON	SVNRM ON	SVNRM?	0:OFF
	Normalize OFF	SVNRM OFF		1:ON (*3)
	Limit Line 1 ON	SVLIM 1	SVLIM?	0:OFF
	2 ON	SVLIM 2		1: 1 ON
1/2 ON	SVLIM 3		2: 2 ON	
OFF	SVLIM ON		3: 1/2 ON	
	SVLIM OFF			
Loss:Freq ON	SVOLSS ON	SVOLSS?	0:OFF	
Loss:Freq OFF	SVOLSS OFF		1:ON (*4)	
Level ON	SVLVL ON	SVLVL?	0:OFF	
Level OFF	SVLVL OFF		1:ON	
Channel ON	SVCH ON	SVCH?	0:OFF	
Channel OFF	SVCH OFF		1:ON	
Spurious ON	SVSPR ON	SVSPR?	0:OFF	
Spurious OFF	SVSPR OFF		1:ON	

- (*1) Add FD: or RAM: to the file name to explicitly indicate a drive name.
(Example) Write a file name such as FD: FILE00.DAT and RAM: REG00.DAT. (.DAT can be omitted.)
- (*2) n = Save/Del/Recall number
A value of 0 to 99 can apply to n.
- (*3) (Available when the TG option is installed.)
- (*4) Enabled if the external mixer is installed.

4.2.9 GPIB Command Codes

Table 4-18 Config

Function	Listener Code	Talker Request	
		Code	Output Format
Title ON erase	LON /**/ LOF	LB? —	Label —
Printer Command Select ESC/P PCL ESC/P Raster	PRTCMD ESC PRTCMD PCL PRTCMD ESCR	PRTCMD?	0:ESC/P 1:PCL 2:ESC/P Raster
Gray level set Gray B/W Small B/W Large Color S-Color Small S-Color Large	PRT GRY PRT MOS PRT MOL PRT COL PRT SCOLS PRT SCOLL	PRT?	0:Gray 1:B/W Small 2:B/W Large 3:Color 4:S-Color Small 5:S-Color Large
Paper Feed ON OFF	PFEED ON PFEED OFF	PFEED?	0: OFF 1: ON
BMP output mode select Color S-Color Gray B/W	HCIMAG COL HCIMAG SCOL HCIMAG GRY HCIMAG MON	HCIMAG?	0:Color 1:Gray 2:B/W 3:S-Color
File compression ON OFF	HCCMPRS ON HCCMPRS OFF	HCCMPRS?	0:OFF 1:ON
File Number	HCFILE *	HCFILE?	Number
Reading Bitmap file	—	BMP?	Binary data<EOL>
Device Select Printer Floppy	HCDEV PRT HCDEV FDD	HCDEV?	0:Printer 1:Floppy
Print ON	HCOPY	—	—
10 MHz internal reference signal source 10 MHz external reference signal source	RFI RFE	FREF?	0:INT 1:EXT
Number of trace points 501 Number of trace points 1001	TPS TPL	TP?	0:501 1:1001

Table 4-19 Preset

Function	Listener Code	Talker Request	
		Code	Output Format
Preset	IP *RST	— —	— —

Table 4-20 Test

Function	Listener Code	Talker Request	
		Code	Output Format
Selftest	—	*TST?	Error No.

Table 4-21 GPIB

Function	Listener Code	Talker Request	
		Code	Output Format
A Trace input/output(ASCII)	TAA	TAA?	DDDDD<DLM> × TRP(*1)
A Trace input/output(BINARY)	TBA	TBA?	2Byte × TRP
B Trace input/output(ASCII)	TAB	TAB?	DDDDD<DLM> × TRP
B Trace input/output(BINARY)	TBB	TBB?	2Byte × TRP
Status byte clear	*CLS	—	—
STB read	—	*STB?	Integer (0 to 255)
SRE read/write	*SRE *	*SRE?	Integer (0 to 255)
ESR read	—	*ESR?	Integer (0 to 255)
ESE read/write	*ESE *	*ESE?	Integer (0 to 255)
OSR read	—	OPREVT?	Integer (0 to 65535)
OSER read	OPR	OPR?	Integer (0 to 65535)
SRQ interruptON	S0	—	—
SRQ interrupt OFF	S1	—	—
SRQ status clear	S2	—	—
Service request mask	RQS *	RQS?	Integer (0 to 255)
Delimiter CR LF <EOI>	DL0	—	—
LF	DL1	—	—
<EOI>	DL2	—	—
CR LF	DL3	—	—
LF <EOI>	DL4	—	—

(*1) TRP = Number of trace points (501/1001)

<DLM> = Delimiter

4.2.9 GPIB Command Codes

Table 4-22 Others

Function	Listener Code	Talker Request	
		Code	Output Format
Display ON Display OFF	ANNOT ON ANNOT OFF	ANNOT?	0:OFF 1:ON
Device ID output	—	*IDN?	Maker name, Device type, Serial No., Revision(*1)
Error number output	—	ERRNO?	Integer
Date setting	SETDATE DATE	SETDATE?	DATE(*2)
Time setting	SETTIME TIME	SETTIME?	TIME(*3)

(*1) (Example) ADVANTEST.R3132.123456789.A00

(*2) DATE in YYMMDD format.

(*3) TIME in HHMMSS format.

Table 4-23 FM Demodulation (OPT73) (1 of 2)

Function	Listener Code	Talker Request	
		Code	Output Format
FM Demod ON OFF	FMDEM ON FMDEM OFF	FMDEM?	0: OFF (*1) 1: ON
FM Demod Range Hz/div	FMRNG *	FMRNG?	0: 1 kHz/div 1: 2.5 kHz/div 2: 5 kHz/div 3: 10 kHz/div 4: 25 kHz/div 5: 50 kHz/div 6: 100 kHz/div 7: 250 kHz/div 8: 500 kHz/div 9: 1 MHz/div 10: 2.5 MHz/div 11: 5 MHz/div 12: 10 MHz/div 13: 25 MHz/div 14: 50 MHz/div
Sensitivity ON OFF	FMSEN ON FMSEN OFF	FMSEN?	0: OFF (*1) 1: ON
Sensitivity Unit	—	FMSUN?	0: Hz/s/ 1: Hz/ms/

(*1) When FM Demod (Sensitivity) is turned on, the units of the following function's output levels are in frequency (Sensitivity): Marker level, Upper (Lower) Fail Point, display line, and reference line.

Table 4-23 FM Demodulation (OPT73) (2 of 2)

Function		Listener Code	Talker Request	
			Code	Output Format
Sensitivity	Range	— FMSRNG *	FMSRNGS? FMSRNG?	R1,R2,R3,R4 (Frequency) 0: Range 1 (Minimum) 1: Range 2 2: Range 3 3: Range 4 (Maximum)
Sensitivity	Aperture	FMAPR *	FMAPR?	Real number (1% to 100%)
Deviation	ON OFF	FMDEV ON FMDEV OFF	FMDEV?	0: OFF 1: ON
Deviation	(P-P)/2 +Peak -Peak Repetition Freq.	— — — —	FMAVG? FMPPK? FMNPK? FMRPF?	Frequency Frequency Frequency Frequency
Linearity	ON OFF	FMLIN ON FMLIN OFF	FMLIN?	0: OFF 1: ON
Linearity Setup mode	ON OFF (Quit) Auto Adj Sample Points Offset Adj Slope Adj	FMLMD ON FMLMD OFF FMLA FMLSMP * FMLOFS * FMLSPLP *	FMLMD? — FMLSMP? FMLOFS? FMLSPLP?	0: OFF 1: ON — Integer (2 to 100) Frequency Frequency
Linearity Error	Max Min	— —	FMLMAX? FMLMIN?	Frequency Frequency
Calibration	All Range Only	FMALL FMONLY	— —	— —

Table 4-24 TG (OPT74)

Function		Listener Code	Talker Request	
			Code	Output Format
TG on TG off	TG TGF	TG? TGF?	0:OFF 1:ON	
TG level	TGL *	TGL?	Level	
Frequency Cal AUTO Manual	TGA TGM *	— TGM?	— Frequency	
Normalize ON Normalize OFF	NORM ON ANORM ON NORM OFF ANORM OFF	NORM? ANORM?	0:OFF 1:ON 0:OFF 1:ON	
Normalize Execute	NORM EX AR	— —	— —	
Save Item Normalize ON Normalize OFF	SVNRM ON SVNRM OFF	SVNRM?	0:OFF 1:ON	

4.2.9 GPIB Command Codes

Table 4-25 Entry

Function	Listener Code	Talker Request	
		Code	Output Format
Numeric value entry	0	---	---
	1	---	---
	2	---	---
	3	---	---
	4	---	---
	5	---	---
	6	---	---
	7	---	---
	8	---	---
	9	---	---
Decimal point	.	---	---
Negative sign	-	---	---
Positive sign	+	---	---
Exponent	EXP E	---	---
GHz	GZ	---	---
MHz	MZ	---	---
KHz	KZ	---	---
Hz	HZ	---	---
mW	MW	---	---
DB relationship	DB	---	---
mA	MA	---	---
Second	SC	---	---
Millisecond	MS	---	---
	MSEC	---	---
Microsecond	US	---	---
	USEC	---	---
Nanosecond	NSEC	---	---
Enter	ENT	---	---
Volt	VOLT	---	---
Millivolt	MV	---	---
Microvolt	UV	---	---
Nanovolt	NV	---	---
%	PER %	---	---

4.2.10 Example Programs

This section describes remote control examples used with GPIB port.

4.2.10.1 Sample Programs for Setting or Reading Measurement Conditions

CAUTION *Visual Basic 4.0 (referred to as VB henceforth) is used in the sample programs shown here. Also, National Instruments-made GPIB board (referred to as NI-made for brevity henceforth) is used for the GPIB control board; NI-made driver is used for the control driver.*

- Program examples using VB

Example VB-1: Setting the center frequency after performing an analyzer master reset

```
Call ibclr(spa)                ' Performs a Device Clear.

Call ibwrt(spa, "IP")          ' preset
Call ibwrt(spa, "CF 30MZ")    ' Set the center frequency to 30 MHz.
```

Example VB-2: Setting the start frequency to 300 kHz, setting the stop frequency to 800 kHz and adding 50 kHz to the frequency offset.

```
Call ibclr(spa)                ' Performs a Device Clear.
Call ibwrt(spa, "FA 300KZ")    ' Set the start frequency to 300 kHz.
Call ibwrt(spa, "FB 800KZ")    ' Set the stop frequency to 800 kHz.
Call ibwrt(spa, "FO 50KZ")    ' Add 50 kHz to the frequency offset.
```

Example VB-3: Setting the reference level to 87 dB μ V (in 5 dB/div) and the RBW to 100 kHz

```
Call ibclr(spa)                ' Performs a Device Clear.

Call ibwrt(spa, "AUNITS DBUV") ' Set the level unit to dB $\mu$ V.
Call ibwrt(spa, "RL 87DB")     ' Set the reference level to 87 dB ( $\mu$ V).
Call ibwrt(spa, "DD 5DB")      ' Set the vertical gradation to 5 dB/div.
Call ibwrt(spa, "RB 100KZ")    ' Set the RBW to 100 kHz.
```

Example VB-4: Setting the instrument using variables

```
Dim A As String
Dim B As String
Dim C As String

A = "10"
B = "2"
C = "20"

Call ibclr(spa)                ' Performs a Device Clear.

Call ibwrt(spa, "CF " & A & "MZ") ' Set the start frequency to A MHz.
Call ibwrt(spa, "SP " & B & "MZ") ' Set the span frequency to B MHz.
Call ibwrt(spa, "AT " & C & "DB") ' Set the ATT to C dB.
```

4.2.10 Example Programs

Example VB-5: Saving set values in Register 5 and recalling them from Register 5

```

Dim LabelBuff As String           ' Character string buffer for the label
LabelBuff = "SPECTRUM Analyzer"  ' Set the label.

Call ibclr(spa)                   ' Performs a Device Clear.

Call ibwrt(spa, "CF 30MZ")        ' Set the parameter.
Call ibwrt(spa, "SP 1MZ")
Call ibwrt(spa, "DET POS")
Call ibwrt(spa, "LON " & LabelBuff) ' Set the label.

Call ibwrt(spa, "SV 5")          ' Save the data in Register 5.

Call ibwrt(spa, "CF 1GZ")        ' Change the set parameters.
Call ibwrt(spa, "SP 200MZ")

Call ibwrt(spa, "RC 5")          ' Recall the data from Register 5.

```

Example VB-6: Enter Limit line1 in the table and turn Limit line 1 on

```

Call ibclr(spa)                   ' Perform a device clear.

Call ibwrt(spa, "LMTADEL")        ' Clear the table used for Limit Line 1.
Call ibwrt(spa, "AUNITS DBUV")    ' Set the unit of level to dBµV.

Call ibwrt(spa, "LMTAIN 25MZ, 49.5DB") ' Enter data use by Limit Line 1.
Call ibwrt(spa, "LMTAIN 35MZ, 49.5DB")
Call ibwrt(spa, "LMTAIN 35MZ, 51.5DB")
Call ibwrt(spa, "LMTAIN 55MZ, 51.5DB")
Call ibwrt(spa, "LMTAIN 55MZ, 54.3DB")
Call ibwrt(spa, "LMTAIN 65MZ, 54.3DB")
Call ibwrt(spa, "LMTAIN 65MZ, 57.0DB")
Call ibwrt(spa, "LMTAIN 68MZ, 57.0DB")
Call ibwrt(spa, "LMTAIN 68MZ, 60.0DB")
Call ibwrt(spa, "LMTAIN 75MZ, 60.0DB")
Call ibwrt(spa, "LMTAIN 75MZ, 62.5DB")
Call ibwrt(spa, "LMTAIN 82MZ, 62.5DB")
Call ibwrt(spa, "LMTAIN 82MZ, 64.7DB")

Call ibwrt(spa, "FA 0MZ")         ' Start frequency of 0 MHz
Call ibwrt(spa, "FB 100MZ")       ' Stop frequency of 100 MHz
Call ibwrt(spa, "LMTA ON")        ' Turn Limit line 1 on.

```

Example VB-7: Sample Program of the Gated Sweep

```

Call ibclr(spa)                   ' Perform a device clear.

Call ibwrt(spa, "GTSRC EXT")      ' Set the Gate signal source to EXT.
Call ibwrt(spa, "GTSLP +")       ' Set the Gate signal slope to plus (+).
Call ibwrt(spa, "GTWID 10MS")    ' Set the window width of the gated sweep to 10 msec.
Call ibwrt(spa, "GTPOS 10US")   ' Set the window position of the gated sweep to 10 µsec.
Call ibwrt(spa, "GTSWP ON")     ' Turn the gated sweep on.

```

4.2.10.2 Sample Programs for Reading Data

In order to output measurement data or settings, use the "xx?" command. This ensures that the data is read when the device is in the talker mode. Available output formats are listed in the table below. The delimiter positioned at the end of data can be specified from 5 types (refer to "Others" in the GPIB code list). Once set, "xx?" command continues to operate until it is changed.

Output Format	
Frequency	\pm <u>D.DDDDDDDDDDD</u> <u>E ± DD</u> <u>CR LF</u> ↑ ↑ ↑ ↑ 1 2 3 4 • Data size (1 to 3) is a maximum of 19 bytes, and the unit is Hz. Example Specify "CF?" and output as center frequency.
Level	\pm <u>D.DDDDDDD</u> <u>E ± DD</u> <u>CR LF</u> ↑ ↑ ↑ ↑ 1 2 3 4 • Data size (1 to 3) is a maximum of 19 bytes, and the unit corresponds to each UNIT setting. Example Specify "ML?" and output as marker level.
Time	\pm <u>D.DDD</u> <u>E ± DD</u> <u>CR LF</u> ↑ ↑ ↑ ↑ 1 2 3 4 • Data size (1 to 3) is a maximum of 19 bytes, and the unit is sec. Example Specify "SW?" and output sweep time.
	<u>DDDD</u> <u>CR LF</u> ↑ ↑ 2 4 • The maximum byte of the data size corresponds to the maximum size of the output data. Example ON/OFF status or Averaging count is output.

<Supplement> 1= Sign (a space for plus sign; "-" for minus sign)
 2= Mantissa of data
 3= Exponent of data
 4= Delimiter (CR/LF in initial setting can be changed with "DLn" code.)

4.2.10 Example Programs

Example VB-8: Output the marker level

```
Dim sep As Integer
Call ibclr(spa) ' Perform a device clear.
Call ibwrt(spa, "CF 30MZ") ' Set the parameter.
Call ibwrt(spa, "SP 1MZ")
Call ibwrt(spa, "MK 30MZ") ' The marker frequency is set to 30 MHz.
Call ibwrt(spa, "TS")
Call ibwrt(spa, "ML?") ' Query command for the marker level.
Rdbuf = Space(30) ' Allocate a total of 30 bytes to the buffer area.
Call ibrd(spa, Rdbuf) ' Read the data (30 bytes Max.).
sep = InStr(1, Rdbuf, vbCrLf, 0) ' Check the number of character to the delimiter.
RichTextBox1.Text = "MarkerLevel = " & Left(Rdbuf, sep - 1)
' Outputs the data on the screen.
```

An example display:
MarkerLevel = -8.818750000000E+01

Example VB-9: Reading the center frequency and displaying it

```
Dim sep As Integer
Call ibclr(spa) ' Performs a Device Clear.
Call ibwrt(spa, "CF?") ' Query command for the center frequency.
Rdbuf = Space(30) ' Allocate the buffer memory space to 30 bytes.
Call ibrd(spa, Rdbuf) ' Read the data (30 bytes Max.)
sep = InStr(1, Rdbuf, vbCrLf, 0) ' Check the number of characters prior to the delimiter.
RichTextBox1.Text = "CenterFreq = " & Left(Rdbuf, sep - 1)
' Display the data on the screen.
```

An example display:
CenterFreq = +3.000000000000E+07

Example VB-10: Reading the level and display unit and displaying them

```

Dim sep As Integer

Call ibclr(spa) ' Performs a Device Clear.

Call ibwrt(spa, "RL?") ' Query command for the reference level.

Rdbuf = Space(30) ' Allocate the buffer memory space to 30 bytes.
Call ibrd(spa, Rdbuf) ' Read the data (30 bytes Max.) from the spectrum analyzer.
sep = InStr(1, Rdbuf, vbCrLf, 0) ' Check the number of characters prior to the delimiter.
RichTextBox1.Text = "RefLevel = " & Left(Rdbuf, sep - 1) ' Display the data on the screen.

Call ibwrt(spa, "AUNITS?") ' Query command for the level unit

Rdbuf = Space(3)
Call ibrd(spa, Rdbuf)
sep = InStr(1, Rdbuf, vbCrLf, 0) ' Check the number of characters prior to the delimiter.
RichTextBox1.Text = RichTextBox1.Text & vbCrLf & "UNIT = " & Left(Rdbuf, sep - 1) ' Display the previous result, followed by a return mark and the
' most recent result.

An example display:
RefLevel = +0.000000000000E+00
UNIT = 0

```

Example VB-11: Executing the 6 dB-down operation, reading the frequency and level and displaying them

```

Dim sep As Integer

Call ibclr(spa) ' Performs a Device Clear.

Call ibwrt(spa, "CF 30MZ") ' Set the parameter.
Call ibwrt(spa, "SP 20MZ")

Call ibwrt(spa, "MKBW 6DB") ' Set a 6 dB down measurement.
Call ibwrt(spa, "PS") ' Peak search.
Call ibwrt(spa, "XDB") ' Perform the 6 dB down measurement.
Call ibwrt(spa, "MFL?") ' Query command for the marker level and frequency.

Rdbuf = Space(50) ' Allocate the buffer memory space to 50 bytes.
Call ibrd(spa, Rdbuf) ' Read the data (50 bytes Max.) from the spectrum analyzer.

sep = InStr(1, Rdbuf, vbCrLf, 0) ' Check the number of characters prior to the delimiter.

RichTextBox1.Text = "Marker Freq & Level = " & Left(Rdbuf, sep - 1) ' Display the data on the screen.

An example display:
Marker Freq & Level = +2.000000000000E+05, +1.023437500000E+00

```

4.2.10 Example Programs

Example VB-12: Measuring OBW and displaying it

```

Dim LENG1 As Integer, LENG2 As Integer
Dim OBW As String
Dim FC As String
Dim searchchar As String

Call ibclr(spa) ' Perform a device clear.

Call ibwrt(spa, "CF 30MZ") ' Send the command already set.
Call ibwrt(spa, "SP 1MZ")
Call ibwrt(spa, "MK 30MZ")
Call ibwrt(spa, "OBW ON")
Call ibwrt(spa, "FS")

Call ibwrt(spa, "OBW?") ' Send the query command.
Rdbuf = Space(60) ' Allocate the area to the read buffer.
Call ibrd(spa, Rdbuf) ' Read the read buffer (the maximum number of bytes to be output
' is determined by the buffer area size).

' Formatting output character string
LENG1 = InStr(1, Rdbuf, Chr(44), 0) ' Search for the first comma.
FC = Mid(Rdbuf, 1, LENG1 - 1) ' Read the character prior to the comma.

DoEvents

LENG2 = InStr(LENG1 + 1, Rdbuf, Chr(13), 0) ' Determine the last data by searching for the delimiter.
OBW = Mid(Rdbuf, (LENG1 + 1), (LENG2 - LENG1 - 1))
' Read the data between the second comma and the delimiter.

RichTextBox1.Text = "OBW = " & OBW & vbCrLf & "Fc = " & FC & vbCrLf
' Display the data on the screen.

An example display:
OBW = +9.810000000000E+05
FC = +3.000250000000E+07

```

Example VB-13: Reading and displaying the three largest peak levels

```
Dim pk1 As String, pk2 As String, pk3 As String
```

```
Call ibclr(spa) ' Perform a device clear.
Call ibwrt(spa, "CF 0MZ") ' Apply the settings.
Call ibwrt(spa, "SP 100MZ")

Call ibwrt(spa, "PS") ' Search for the peak.
Call ibwrt(spa, "ML?") ' Query command to search for the marker level
Rdbuf = Space(25) ' Reserve buffer memory space.
Call ibrd(spa, Rdbuf) ' Receives the output.
pk1 = LeftB(Rdbuf, (InStrB(1, Rdbuf, Chr(13), 1) - 1)) ' Read the data between the starting point and the delimiter.

Call ibwrt(spa, "NXP") ' Search for the next peak.
Call ibwrt(spa, "ML?")
Rdbuf = Space(25)
Call ibrd(spa, Rdbuf)
pk2 = LeftB(Rdbuf, (InStrB(1, Rdbuf, Chr(13), 1) - 1)) ' Read the data between the starting point and the delimiter.

Call ibwrt(spa, "NXP")
Call ibwrt(spa, "ML?")
Rdbuf = Space(25)
Call ibrd(spa, Rdbuf)
pk3 = LeftB(Rdbuf, (InStrB(1, Rdbuf, Chr(13), 1) - 1)) ' Read the data between the starting point and the delimiter.

RichTextBox1.Text = "1st PK = " & pk1 & vbCrLf & "2nd PK = " & pk2 & vbCrLf & "3rd PK = " & pk3 & vbCrLf
' Display the data on the screen.
```

An example display:

```
1st PK = -8.553906250000E+01
2nd PK = -7.004687500000E+01
3rd PK = -8.655468750000E+01
```

4.2.10 Example Programs

4.2.10.3 Sample Programs for Inputting or Outputting Trace Data

Trace data on the screen includes data for 501 or 1001 points on the frequency axis. For inputting and outputting data, it is necessary to transfer data for 501 or 1001 points from the left side (start frequency) in order. Each point level is expressed by an integer from 1792 to 14592 (however, if the trace exceeds the upper limit of the vertical scale, a value greater than 14592 is transferred).

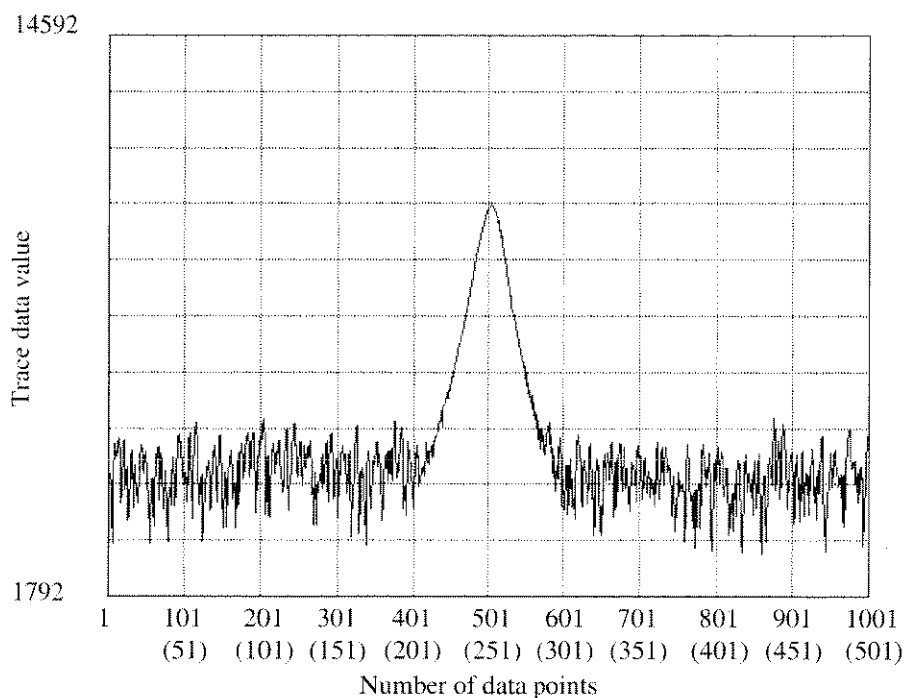

Figure 4-4 Relationship between Screen Graticule and Trace Data

Trace data can be input or output in either ASCII or binary format.

Table 4-26 Trace Accuracy Specification Codes

GPIB Code	Description
TPS	Sets the number of measurement points to 501.
TPL	Sets the number of measurement points to 1001.

Table 4-27 I/O format

I/O format	Description	
ASCII format	<p style="text-align: center;"> <u>DDDDD</u> CR LF ↑ ↑ Delimiter Data for one point Five-byte data without header </p>	
		Input GPIB code
	Memory A Memory B	TAA TAB
Binary format	<p style="text-align: center;"> <u>DD</u> <u>DD</u> <u>DD</u> <u>DD + EOI</u> ↑ ↑ ↑ ↑ ↑ High-order byte Low-order byte High-order byte Low-order byte Delimiter for 1st point for 1st point for 1001/501st point for 1001/501st point High-order byte High-order byte for 1st point for 1001/501st point </p> <p>Each point data is divided into two parts: high-and low-order bytes. EOI signal is attached at the end of the data for continuous 1001/501 points.</p>	
		Input GPIB code
	Memory A Memory B	TBA TBB

4.2.10 Example Programs

Example VB-14: Read the trace data in ASCII format

```

Dim tr(1000) As String           ' Allocate an array in the buffer for 1001 points.
Dim i As Integer
Dim res As String

Call ibclr(spa)                 ' Perform a device clear.

Call ibwrt(spa, "DL0")         ' CR LF EOI
Call ibwrt(spa, "DET NEG")     ' Set it to the negative detector.
Call ibwrt(spa, "TAA?")

For i = 0 To 1000 Step 1       ' Repeat the operation for 1001 points.
    tr(i) = Space(7)           ' Allocate a total of 7 bytes (5 bytes for the data, and 2 bytes for
                                ' delimiters).
    Call ibrd(spa, tr(i))      ' Read the data.
                                ' Output it to the screen.
    res = res & "tr(" & Str(i) & ") = " & Left(tr(i), 5) & vbCrLf
    DoEvents
Next i

RichTextBox1.Text = res

```

Example VB-15: Read the A memory data in binary format

```

Dim tr(1000) As Integer        ' Allocates an array in the buffer for 1001 points.
Dim i As Integer
Dim res As String

Call ibclr(spa)               ' Performs a device clear.
Call ibconfig(0, IbcEndBitIsNormal, 0) ' Sets the GPIB-board software so that the End bit of the Ibst
                                ' variables is set to 1 only when EOI has been received.
Call ibconfig(spa, IbcReadAdjust, 1) ' Sets the spectrum analyzer so that the upper byte is swapped for
                                ' the lower byte during a read operation.

Call ibwrt(spa, "DL2")        ' Sets the delimiter to EOI only.
Call ibwrt(spa, "DET NEG")    ' Sets it to the negative detector.
Call ibwrt(spa, "TBA?")      ' Query for Trace A in binary data

Call ibrdi(spa, tr(), 1001 * 2) ' Reads binary data for 1001 points.

For i = 0 To 1000 Step 1     ' Repeats the operation for 1001 points.
    res = res & Str(tr(i)) & vbCrLf ' Outputs it to the screen.
    DoEvents
Next i

RichTextBox1.Text = res

Call ibwrt(spa, "DL0")       ' Sets the delimiter to the CR, LF and EOI.
Call ibconfig(0, IbcEndBitIsNormal, 1) ' Resets the GPIB software to the standard settings.
Call ibconfig(spa, IbcReadAdjust, 0)

```

Example VB-16: Enter data into A memory in ASCII mode
(When the 501 point mode is set, change 1001 and 1000 to 501 and 500, respectively.)

```
Dim trdata(1000) As Integer
Dim i As Integer

trdata(0) = 1792
For i = 1 To 1000 Step 1
    trdata(i) = Str(Val(trdata(i - 1)) + 12)
    DoEvents
Next i

Call ibclr(spa)
Call ibwrt(spa, "AB")
Call ibwrt(spa, "TAA")

For i = 0 To 1000 Step 1
    Call ibwrt(spa, CStr(trdata(i)))
    DoEvents
Next i

Call ibwrt(spa, "AV")
```

' Provide a temporary data used to test the input (*).
' When there is the data, the steps between the place marked with (*) and this point are not required.
' Perform a device clear.
' Set Trace A to BLANK.
' Set Trace A in ASCII.
' Repeats the operation for 1001 points.
' Sends the value after it has been converted to the ASCII data.
' Set Trace A to VIEW.

4.2.10 Example Programs

4.2.10.4 Example program using the TS (Take Sweep) command

Example VB-17: An ACP measurement is taken and then the measurement result is read (using the TS command).

```

Dim state As Integer
Dim sep1 As Integer, sep2 As Integer
Dim i As Integer, j As Integer
Dim cnt As Integer
Dim LvLH As String, LvL As String
Dim FrqH As String, FrqL As String

Call ibclr(spa) 'A device clear is carried out.

Call ibwrt(spa, "SI") 'Set the single mode.
Call ibwrt(spa, "CF 1500MZ") 'Set the center frequency to 1500 MHz.
Call ibwrt(spa, "SP 250KZ") 'Set the frequency span to 250 kHz.
Call ibwrt(spa, "RB 1KZ") 'Set RBW to 1 kHz.
Call ibwrt(spa, "VB 3KZ") 'Set VBW to 3 kHz.
Call ibwrt(spa, "ST 20SC") 'Set the sweep time to 20 sec.
Call ibwrt(spa, "CSBSDEL") 'Clear the channel space and bandwidth previously set.
Call ibwrt(spa, "CSBSIN 50KZ.21KZ") 'Set CS to 50 kHz. and BS to 21 kHz.
Call ibwrt(spa, "OPR 256") 'The Averaging bit of the operation register is set
to ENABLE.

Call ibwrt(spa, "*CLS") 'Clear STATUS byte
Call ibwrt(spa, "SRQ") 'SRQ is enabled.
Call ibwrt(spa, "ACP ON") 'Start the ACP measurement.

For j = 1 To 10 Step 1
    Call ibwrt(spa, "TS") 'Execute one sweep.
    Call ibwrt(spa, "ACP?") 'The ACP measurement result has been requested.
    Rdbuf = Space(3) 'Assign an area for 1 byte of integer and 2 bytes of delimiter prior
to reading the result.

    Call ibrd(spa, Rdbuf) 'Read the data.
    cnt = CInt(Rdbuf) 'Convert the contents of the buffer into integer type data.

For i = 1 To cnt Step 1
    Rdbuf = Space(81) 'Assign an area of 81 bytes (Real number x 4 + ',' x 3 + CRLF).
    Call ibrd(spa, Rdbuf) 'Read the data.

    sep1 = InStr(1, Rdbuf, ",", 0) 'Search for the first comma starting from the top of the buffer.
    FrqL = Left(Rdbuf, sep1 - 1) 'Read the string between the top and the character string.
    sep2 = InStr(sep1 + 1, Rdbuf, ",", 0) 'Search for the next comma.
    LvL = Mid(Rdbuf, sep1 + 1, sep2 - sep1 - 1) 'Read the string between the first and second separators (com-
mas).

    sep1 = InStr(sep2 + 1, Rdbuf, ",", 0) 'Search for the third comma.
    FrqH = Mid(Rdbuf, sep2 + 1, sep1 - sep2 - 1) 'Read the string between the second and third separators (com-
mas).

    sep2 = InStr(sep1, Rdbuf, Chr(13), 0) 'Search for the terminator (CR).
    LvLH = Mid(Rdbuf, sep1 + 1, sep2 - sep1 - 1) 'Read the string between the separators (third comma and CR).

    'Displays the result on the screen.
    RichTextBox1.Text = RichTextBox1.Text & FrqL & "Hz:" & LvL & vbCrLf
    RichTextBox1.Text = RichTextBox1.Text & FrqH & "Hz:" & LvLH & vbCrLf

Next i
DoEvents
Next j

```

4.2.10.5 Program Examples Using the Status Byte

Example VB-18: Execute single sweeping and wait until its finished (when not using SRQ)

```

Dim state As Integer

Call ibclr(spa) ' Performs a Device Clear.
Call ibwrt(spa, "SI") ' Turn the single sweep mode on.
Call ibwrt(spa, "OPR8") ' Enables Sweep-end bit of operation status register
Call ibwrt(spa, "*CLS") ' Clear the status byte.
Call ibwrt(spa, "SI") ' Begin sweeping.

Do

    Call ibwrt(spa, "*STB?") ' Query command to read the status byte.
    Rdbuf = Space(8) ' Reserve a maximum of 8 bytes including the delimiter.
    Call ibrd(spa, Rdbuf) ' Read the data.
    state = Val(Rdbuf) ' Convert the character string into numeric values.

    DoEvents ' Check the loop for other events currently taking place.
Loop Until (state And 128) ' Exit from the loop if the sweep-end bit is set to 1.

```

Example VB-19: Reading the peak frequency and level at the end of a single sweep (when using SRQ)

```

Dim boardID As Integer
Dim I As Integer
Dim res As Integer
Dim CFLEV As String

boardID = 0 ' Set the board ID.

Call ibclr(spa) ' Performs a Device Clear.

Call ibwrt(spa, "SI") ' Turn the single sweep mode on.

Call ibwrt(spa, "*CLS") ' Clear the status byte.
Call ibwrt(spa, "OPR 8") ' Enables the Sweep-end bit of the operation status register
Call ibwrt(spa, "*SRE 128") ' Enables the Operation status bit of the status byte.
Call ibwrt(spa, "S0") ' Specify Send mode for the SRQ signal.

For I = 1 To 10 Step 1 ' A loop of 10 times
    Call ibwrt(spa, "SI") ' Begin sweeping
    Call WaitSRQ(boardID, res) ' Wait until SRQ interruption occurs.
    Call ibrsp(spa, res) ' Execute serial polling.

    Call ibwrt(spa, "PS") ' Execute the peak search.
    Call ibwrt(spa, "MFL?") ' Query for marker frequency and level

    Rdbuf = Space(43) ' Reserve 43 bytes.
    Call ibrd(spa, Rdbuf) ' Read the data.

    CFLEV = Left(Rdbuf, InStr(1, Rdbuf, Chr(13), 0) - 1)
    RichTextBox1.Text = RichTextBox1.Text & "Freq ,Label = " & CFLEV & vbCrLf
    ' Display data on the screen and start a new line.

    DoEvents ' Execute other events in Windows if any.
Next I

```

4.2.10 Example Programs

4.2.10.6 Example Program Used to Read Screen Data

Example VB-20: Outputting the current screen data in bitmap format and saving it into the file (bitmap.bmp)

NOTE: *Depending on the copy image, compression of files and screen status, the amount of bitmap data varies. A data file of up to 300 KB can be output.*

Tmo%=14	' A timeout of 30 sec.
Call ibtmo(spa,tmo%)	' A timeout of 30 seconds is set.
Call ibwrt(spa,"DL2")	' Selects only EOI as a delimiter.
Call ibwrt(spa,"HCIMAG SCOL")	' Sets a simple color image to make a copy.
Call ibwrt(spa,"HCCMPRS OFF")	' Turns the compression mode off.
Call ibwrt(spa,"BMP?")	' Requests the bitmap data output.
Call ibrdf(spa,"bitmap.bmp")	' Saves the bitmap data into the file.
Call ibwrt(spa,"DLO")	' Changes the delimiter back to CR, LF and EOI.

4.3 RS-232 Remote Control Function

Most controllers (such as personal computers) do not have a GPIB interface, but the R3132 series can still be controlled using the RS-232 interface.

4.3.1 GPIB and RS-232 Compatibility

The control codes and functions are the same as those used for serial control, except for those which especially refer to the GPIB interface.

4.3.2 Features of RS-232 Remote Control

The following functions can be controlled by serial control.

- Measurement conditions setup: Measurement conditions each can be input in much the same as the key operation on the front panel.
- Output of the setup status: Both the setup status and data can be read out.
- Status: Status bytes which show the current status of the spectrum analyzer can be read out in the same way GPIB readouts.

4.3.3 Parameter Setup Window

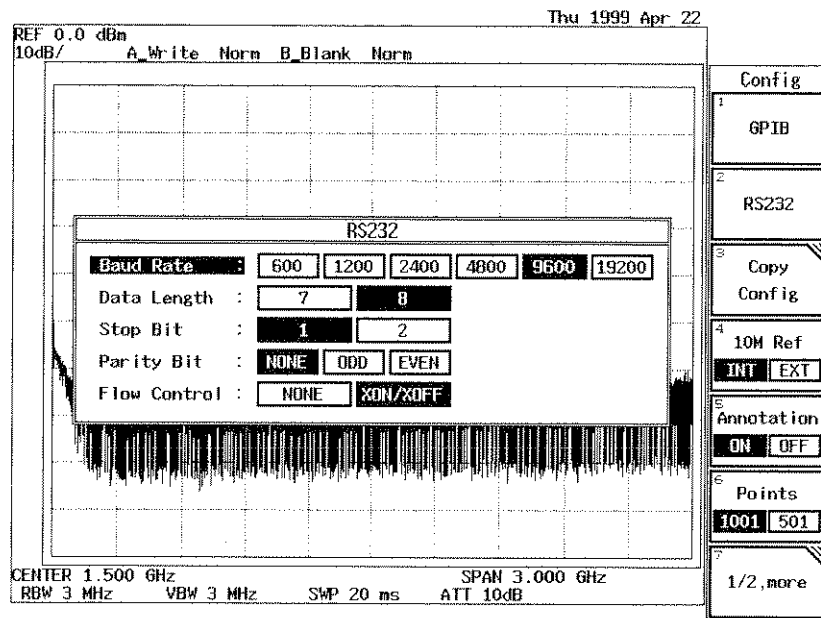

Figure 4-5 Parameter Setup

1. Baud Rate: Select from 600, 1200, 2400, 4800, 9600 or 19200.
2. Data length: Select seven bits or eight bits as the number of data bits.
3. Stop bit: Select one or two bits.
4. Parity check: Select from NONE, ODD or EVEN.
5. Flow control: Selects whether or not to use flow control XON/XOFF.

4.3.4 Interface connection

4.3.4 Interface connection

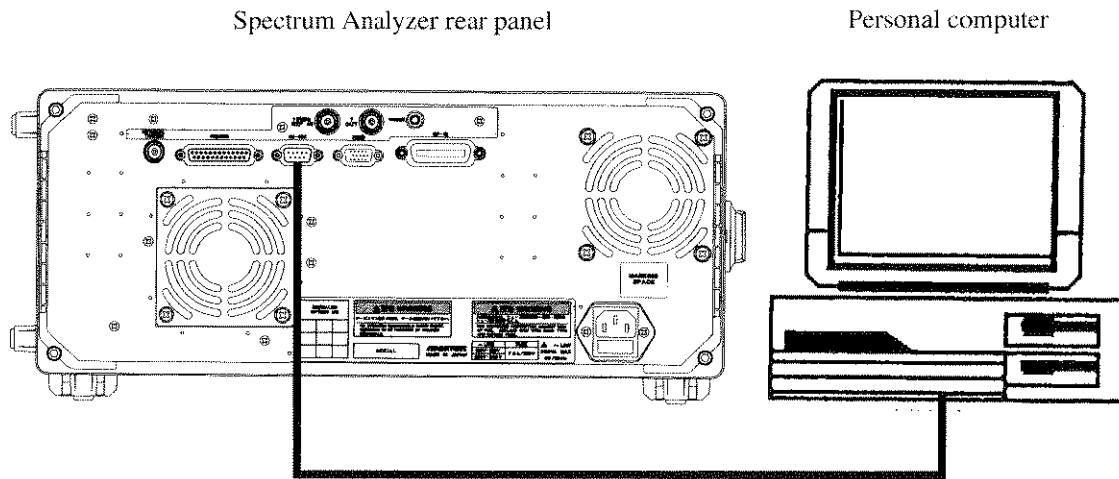
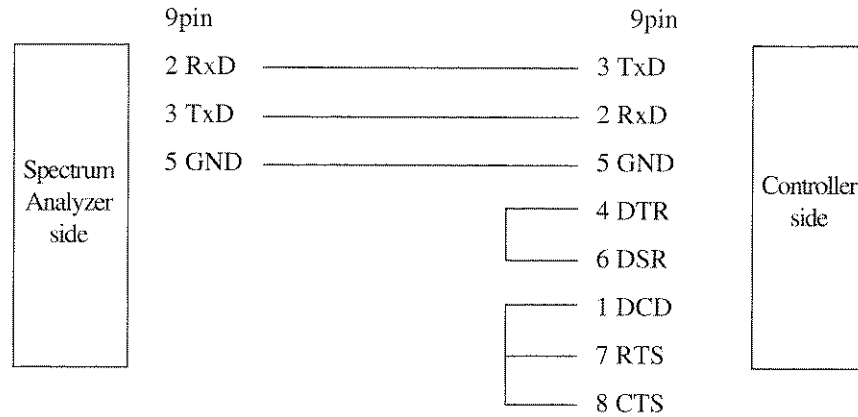

Figure 4-6 Connection Between the Controller and the Spectrum Analyzer

Although the spectrum analyzer uses only three pins, the controller side needs more connections for input and output.

NOTE:

1. When you send or receive data using the cable connections shown in Figure 4-6, set XON/XOFF to valid (ON).
2. DCD, DTR and DSR are not used in the spectrum analyzer. When you use CTS and RTS, use a cable with cross-connection to connect the controller to the spectrum analyzer. Flow control is not performed using CTS or RTS. Set XON/XOFF to valid (ON) to perform flow control.



Pin No.(9pin)	Signal name	Contents
1	DCD:Data Carrier Detector	Receive carrier detection
2	RxD: Receive Data	Receive data
3	TxD: Transmit Data	Transmission data
4	DTR: Data Terminal Ready	Data terminal ready
5	GND: Ground	Signal ground
6	DSR: Data set Ready	Data set ready
7	RTS: Request To Send	Request signal for sending
8	CTS: Clear to Send	Clear signal for sending
9	CI:	N.C

Figure 4-7 Cable Wiring Diagram

4.3.5 Data Format

Transmission messages between the spectrum analyzer and the controller are in ASCII code character strings and followed by carriage returns (CR) and line feeds (LF).

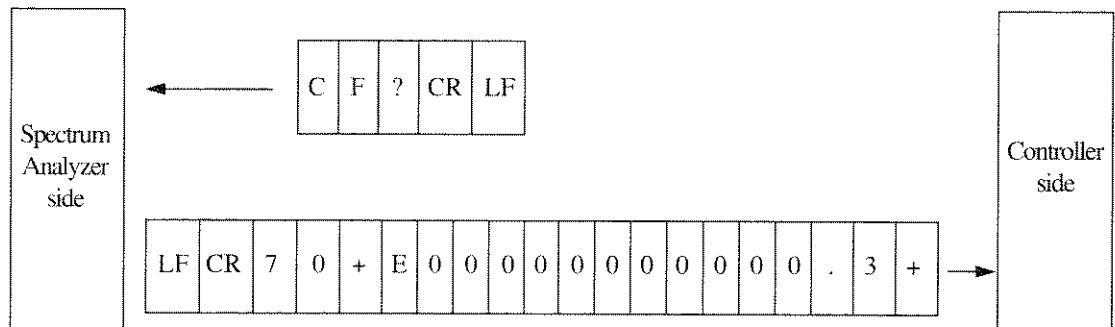

Figure 4-8 Data Format

4.3.6 Differences Between RS-232 and GPIB

NOTE:

1. *Transmission data must be in ASCII code.*
 2. *Delimit the data from the controller with CR or CR and LF. Query data and the GPIB delimiters are the same. Therefore, send DL0 or DL3 after serial port was opened (refer to the example of RS-232 remote program).*
-

Data transmission example: Personal computers can recognize both CF 30.0MZ CR and CF 30.0MZ CR LF.

The format for query data is +3.0000000000E+07 CR LF (send DL0 or DL3). The output data of this RS-232 and GPIB are the same number of characters except delimiters (CR and LF).

4.3.6 Differences Between RS-232 and GPIB

- Command code
- Trace data can be input or output in the ASCII format only.
-

CAUTION *The following commands are unavailable: TBA and TBB.*

4.3.7 Panel Control

During remote control operation, spectrum analyzer panel control is affected as follows.

- The remote lamp does not light.
 - The key panel is not disabled.
-

CAUTION *If any settings are changed during remote control, the operation of the spectrum analyzer may become unstable.*

4.3.8 Remote Control Usage Examples

The following examples show typical remote control commands, and are written in "Microsoft Quick Basic" (licensed by Microsoft Corporation).

The Open command statement OPEN" COM1: 9600, N, 8, 1, ASC" FOR RANDOM AS #1 shown below has the following characteristics: baud rate is 9600 bps, no parity, 8 bit data length, stop bit of 1, ASCII format and random access mode.

Example: This program is used to check the status byte register to see if the sweep has been completed.

```
OPEN "COM1:9600,N,8,1,ASC" FOR RANDOM AS #1
PRINT #1, "DL3"           ' CR and LF are set as the GPIB delimiter.
PRINT #1, "SI"           ' Single sweep is performed.
PRINT #1, "OPR8"        ' Sweep completion bit in the GPIB operation register is set.
PRINT #1, "CLS"         ' Clearing the status bytes.
PRINT #1, "SI"         ' Single sweep is performed.
MEAS.LOOP:
PRINT #1, "*STB?"      ' Read out the status bytes.
INPUT #1, STAT
IF (STAT AND 128) = 0 THEN GOTO MEAS.LOOP
PRINT #1, "PS"         ' Peak search.
PRINT #1, "ML?"       ' Read out the peak level.
INPUT#1,MLEVEL
PRINT MLEVEL
CLOSE #1
END
```